

# SYLVANIA

## Digital Video Disc Recorder

### Owner's Manual **ZC350SL8**

**INSTRUCCIONES EN ESPAÑOL INCLUIDAS**

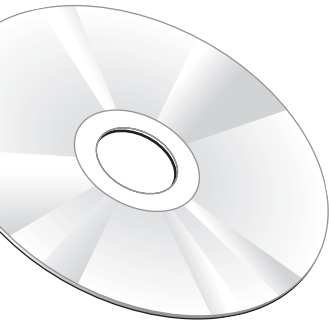

**TO RECEIVE DIGITAL/ANALOG SIGNAL, YOU MUST CONNECT ANTENNA.**

IF YOU NEED ADDITIONAL ASSISTANCE WITH SETUP OR OPERATING AFTER READING OWNER'S MANUAL, PLEASE CALL TOLL FREE **1-800-968-3429**, OR VISIT OUR WEB SITE AT **<http://www.SylvaniaConsumerElectronics.com>**

# PRECAUTIONS

**WARNING:** TO REDUCE THE RISK OF FIRE OR ELECTRIC SHOCK, DO NOT EXPOSE THIS APPLIANCE TO RAIN OR MOISTURE.



**CAUTION**  
**RISK OF ELECTRIC SHOCK**  
**DO NOT OPEN**



**CAUTION:**

TO REDUCE THE RISK OF ELECTRIC SHOCK, DO NOT REMOVE COVER (OR BACK). NO USER SERVICEABLE PARTS INSIDE. REFER SERVICING TO QUALIFIED SERVICE PERSONNEL.



The lightning flash with arrowhead symbol, within an equilateral triangle, is intended to alert the user to the presence of uninsulated "dangerous voltage" within the product's enclosure that may be of sufficient magnitude to constitute a risk of electric shock to persons.



The exclamation point within an equilateral triangle is intended to alert the user to the presence of important operating and maintenance (servicing) instructions in the literature accompanying the appliance.

The caution marking is located on the rear of the cabinet.

## Laser Safety

This unit employs a laser. Only a qualified service person should remove the cover or attempt to service this device, due to possible eye injury.

**CAUTION:** USE OF CONTROLS OR ADJUSTMENTS OR PERFORMANCE OF PROCEDURES OTHER THAN THOSE SPECIFIED HEREIN MAY RESULT IN HAZARDOUS RADIATION EXPOSURE.

**CAUTION:** VISIBLE AND INVISIBLE LASER RADIATION WHEN OPEN AND INTERLOCK DEFEATED. DO NOT STARE INTO BEAM.

**LOCATION:** INSIDE, NEAR THE DECK MECHANISM.

**FCC WARNING- This equipment may generate or use radio frequency energy. Changes or modifications to this equipment may cause harmful interference unless the modifications are expressly approved in the manual. The user could lose the authority to operate this equipment if an unauthorized change or modification is made.**

## RADIO-TV INTERFERENCE

This equipment has been tested and found to comply with the limits for a Class B digital device, pursuant to Part 15 of the FCC Rules. These limits are designed to provide reasonable protection against harmful interference in a residential installation. This equipment generates, uses, and can radiate radio frequency energy and, if not installed and used in accordance with the instructions, may cause harmful interference to radio communications. However, there is no guarantee that interference will not occur in a particular installation. If this equipment does cause harmful interference to radio or television reception, which can be determined by turning the equipment off and on, the user is encouraged to try to correct the interference by one or more of the following measures:

- 1) Reorient or relocate the receiving antenna.
- 2) Increase the separation between the equipment and receiver.
- 3) Connect the equipment into an outlet on a circuit different from that to which the receiver is connected.
- 4) Consult the dealer or an experienced radio/TV technician for help.

**This Class B digital apparatus complies with Canadian ICES-003.**

**Cet appareil numérique de la classe B est conforme à la norme NMB-003 du Canada.**

**CAUTION: TO PREVENT ELECTRIC SHOCK, MATCH WIDE BLADE OF PLUG TO WIDE SLOT, FULLY INSERT.**

**ATTENTION: POUR ÉVITER LES CHOCS ÉLECTRIQUES, INTRODUIRE LA LAME LA PLUS LARGE DE LA FICHE DANS LA BORNE CORRESPONDANTE DE LA PRISE ET POUSSER JUSQU'AU FOND.**

## A NOTE ABOUT RECYCLING

This product's packaging materials are recyclable and can be reused. Please dispose of any materials in accordance with your local recycling regulations.

Batteries should never be thrown away or incinerated but disposed of in accordance with your local regulations concerning chemical wastes.

## Make your contribution to the environment!!!

- Used up batteries do not belong in the dust bin.
- You can dispose of them at a collection point for used up batteries or special waste. Contact your council for details.



For Customer Use:

Read carefully the information located at the back of this unit and enter below the Model No. and Serial No. Retain this information for future reference.

Model No. \_\_\_\_\_

Serial No. \_\_\_\_\_

## Important Safeguards

1. Read Instructions - All the safety and operating instructions should be read before the appliance is operated.
2. Retain Instructions- The safety and operating instructions should be retained for future reference.
3. Heed Warnings - All warnings on the appliance and in the operating instructions should be adhered to.
4. Follow Instructions - All operating and use instructions should be followed.
5. Cleaning - Unplug this product from the wall outlet before cleaning. Do not use liquid cleaners or aerosol cleaners. Use a damp cloth for cleaning.  
EXCEPTION: A product that is meant for uninterrupted service and, that for some specific reason, such as the possibility of the loss of an authorization code for a CATV converter, is not intended to be unplugged by the user for cleaning or any other purpose, may exclude the reference to unplugging the appliance in the cleaning description otherwise required in item 5.
6. Attachments - Do not use attachments not recommended by the product manufacturer as they may cause hazards.
7. Water and Moisture- Do not use this product near water, for example, near a bath tub, wash bowl, kitchen sink, or laundry tub, in a wet basement, or near a swimming pool, and the like.
8. Accessories - Do not place this product on an unstable cart, stand, tripod, bracket, or table. The product may fall, causing serious injury to a child or adult, and serious damage to the appliance. Use only with a cart, stand, tripod, bracket, or table recommended by the manufacturer, or sold with the product. Any mounting of the appliance should follow the manufacturer's instructions and should use a mounting accessory recommended by the manufacturer. An appliance and cart combination should be moved with care. Quick stops, excessive force, and uneven surfaces may cause the appliance and cart combination to overturn.
9. Ventilation - Slots and openings in the cabinet are provided for ventilation and to ensure reliable operation of the product and to protect it from overheating, and these openings must not be blocked or covered. The openings should never be blocked by placing the product on a bed, sofa, rug, or other similar surface. This product should not be placed in a built-in installation such as a bookcase or rack unless proper ventilation is provided or the manufacturer's instructions have been adhered to.
10. Power Sources - This product should be operated only from the type of power source indicated on the marking label. If you are not sure of the type of power supply to your home, consult your appliance dealer or local power company. For products intended to operate from battery power, or other sources, refer to the operating instructions.
11. Grounding or Polarization - This product is equipped with a polarized alternating-current line plug (a plug having one blade wider than the other). This plug will fit into the power outlet only one way. This is a safety feature. If you are unable to insert the plug fully into the outlet, try reversing the plug. If the plug should still fail to fit, contact your electrician to replace your obsolete outlet. Do not defeat the safety purpose of the polarized plug.
12. Power Cord Protection - Power supply cords should be routed so that they are not likely to be walked on or pinched by items placed upon or against them, paying particular attention to cords at plugs, convenience receptacles, and the point where they exit from the appliance.
13. Outdoor Antenna Grounding - If an outside antenna or cable system is connected to the product, be sure the antenna or cable system is grounded so as to provide some protection against voltage surges and built-up static charges. Article 810 of the National Electrical Code, ANSI/NFPA No. 70, provides

information with regard to proper grounding of the mast and supporting structure, grounding of the lead-in wire to an antenna discharge unit, size of grounding conductors, location of antenna-discharge unit, connection to grounding electrodes, and requirements for the grounding electrode. (Fig. A)

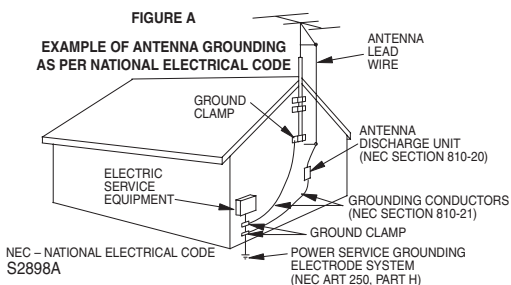

14. Lightning - For added protection for this product during a lightning storm, or when it is left unattended and unused for long periods of time, unplug it from the wall outlet and disconnect the antenna or cable system. This will prevent damage to the product due to lightning and power-line surges.
15. Power Lines - An outside antenna system should not be located in the vicinity of overhead power lines or other electric light or power circuits, or where it can fall into such power lines or circuits. When installing an outside antenna system, extreme care should be taken to keep from touching such power lines or circuits as contact with them might be fatal.
16. Overloading - Do not overload wall outlets and extension cords as this can result in a risk of fire or electric shock.
17. Object and Liquid Entry - Never push objects of any kind into this product through any openings as they may touch dangerous voltage points or short-out parts that could result in a fire or electric shock. Never spill liquid of any kind on the product.
18. Servicing - Do not attempt to service this product yourself as opening or removing covers may expose you to dangerous voltage or other hazards. Refer all servicing to qualified service personnel.
19. Damage Requiring Service - Unplug this product from the wall outlet and refer servicing to qualified service personnel under the following conditions:
  - a. When the power-supply cord or plug is damaged.
  - b. If liquid has been spilled, or objects have fallen into the product.
  - c. If the product has been exposed to rain or water.
  - d. If the product does not operate normally by following the operating instructions. Adjust only those controls that are covered by the operating instructions as an improper adjustment of other controls may result in damage and will often require extensive work by a qualified technician to restore the product to its normal operation.
  - e. If the product has been dropped or damaged in any way.
  - f. When the product exhibits a distinct change in performance this indicates a need for service.
20. Replacement Parts - When replacement parts are required, be sure the service technician has used replacement parts specified by the manufacturer or have the same characteristics as the original part. Unauthorized substitutions may result in fire, electric shock or other hazards.
21. Safety Check - Upon completion of any service or repairs to this product, ask the service technician to perform safety checks to determine that the product is in proper operating condition.
22. Heat - This product should be situated away from heat sources such as radiators, heat registers, stoves, or other products (including amplifiers) that produce heat.

PORTABLE CART WARNING  
(Symbol provided by RETAC)



S3125A

# PRECAUTIONS

## Installation Location

For safety and optimum performance of this unit:

- Install the unit in a horizontal and stable position. Do not place anything directly on top of the unit. Do not place the unit directly on top of the TV.
- Shield it from direct sunlight and keep it away from devices of intense heat. Avoid dusty or humid places. Avoid places with insufficient ventilation for proper heat dissipation. Do not block the ventilation holes on the sides of the unit. Avoid locations subject to strong vibration or strong magnetic fields.

## Avoid the Hazards of Electrical Shock and Fire

- Do not handle the power cord with wet hands.
- Do not pull on the power cord when disconnecting it from AC outlet. Grasp it by the plug.
- If, by accident, water is spilled on this unit, unplug the power cord immediately and take the unit to our Authorized Service Center for servicing.

## Moisture Condensation Warning

Moisture condensation may occur inside the unit when it is moved from a cold place to a warm place or after heating a cold room or under conditions of high humidity. Do not use this unit at least for 2 hours until its inside gets dry.

## About Copyright

Unauthorized copying, broadcasting, public performance and lending of discs are prohibited.

This product incorporates copyright protection technology that is protected by U.S. patents and other intellectual property rights. Use of this copyright protection technology must be authorized by Macrovision, and is intended for home and other limited viewing uses only unless otherwise authorized by Macrovision. Reverse engineering or disassembly is prohibited.

## Notice for Progressive Scan Output

Consumers should note that not all high definition television sets are fully compatible with this product and may cause artifacts to be displayed in the picture. In case of picture problems with 525 progressive scan output, it is recommended that the user switch the connection to the 'standard definition' output. If there are questions regarding your TV set compatibility with this 525p DVD player, please contact our customer service center.

## Supplied Accessories

remote control (NB657UD) with batteries (AAx2)

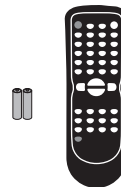

RF coaxial cable (WPZ0901TM002)

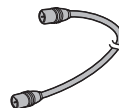

RCA audio/video cables (WPZ0102TM018/WPZ0102LTE01)

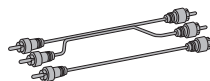

owner's manual (1VMN23369)

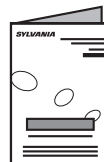

quick guide (1VMN23371)



## Maintenance

### Servicing

- Please refer to relevant topics on "TROUBLESHOOTING" on pages 89-92 before returning the product.
- If this unit becomes inoperative, do not try to correct the problem by yourself. There are no user-serviceable parts inside. Turn off, unplug the power plug and please call our help line mentioned on the front page to locate an Authorized Service Center.

### Cleaning the cabinet

- Use a soft cloth slightly moistened with a mild detergent solution. Do not use a solution containing alcohol, spirits, ammonia or abrasive.

### Cleaning discs

- When a disc becomes dirty, clean it with a cleaning cloth. Wipe the disc from the center to out. Do not wipe in a circular motion.
- Do not use solvents such as benzene, thinner, commercially available cleaners, detergent, abrasive cleaning agents or antistatic spray intended for analog records.

### Cleaning the disc lens

- If this unit still does not perform properly although you refer to the relevant sections and to "TROUBLESHOOTING" in this owner's manual, the laser optical pickup unit may be dirty. Consult your dealer or an Authorized Service Center for inspection and cleaning of the laser optical pickup unit.

### Disc handling

- Handle the discs so that fingerprints and dust do not adhere to the surfaces of the discs.
- Always store the disc in its protective case when it is not used.

### IR signal check

If the remote control does not work properly, you can test if the remote control sends out the infrared signal with AM radio or a digital camera (including built-in camera of cellular phone). It will help to define the cause of malfunction.

#### • With an AM radio:

Tune an AM radio to a station with no broadcasting. Press a button on remote control toward the radio. Sound will be fluttering when you press any key and the radio receives the signal. This means the remote control is working.



#### • With a digital camera (including built-in camera of cellular phone):

Direct a digital camera to remote control, press and hold a button on remote control. If infrared light appears through digital camera, the remote control is working.



"Kodak Picture CD COMPATIBLE" is a trademark of Eastman Kodak Company.



Manufactured under license from Dolby Laboratories. "Dolby" and the double-D symbol are trademarks of Dolby Laboratories.

### Dolby Digital Recording

"Dolby® Digital Recording enables consumers to record high-quality video with stereo sound on recordable DVD discs. The technology, when utilized instead of PCM recording, also saves recordable disc space, allowing for higher video resolution or extended recording time on each DVD. DVDs created using Dolby Digital Recording will play back on all DVD-video players."

**Note:** This is true when the players are compatible with actual recordable DVD discs.

© 2007 Funai Electric Co., Ltd.

All rights reserved. No part of this manual may be reproduced, copied, transmitted, disseminated, transcribed, downloaded or stored in any storage medium, in any form or for any purpose without the express prior written consent of Funai. Furthermore, any unauthorized commercial distribution of this manual or any revision hereto is strictly prohibited.

Information in this document is subject to change without notice. Funai reserves the right to change the content herein without the obligation to notify any person or organization of such changes.

**FUNAI** with the  design is a registered trademark of Funai Electric Co., Ltd and may not be used in any way without the express written consent of Funai. All other trademarks used herein remain the exclusive property of their respective owners. Nothing contained in this manual should be construed as granting, by implication or otherwise, any license or right to use any of the trademarks displayed herein. Misuse of any trademarks or any other content in this manual is strictly prohibited. Funai shall aggressively enforce its intellectual property rights to the fullest extent of the law.

# CONTENTS

## Introduction

<b>PRECAUTIONS</b> .....	<b>2</b>
<b>FEATURES</b> .....	<b>7</b>
Symbols Used in this Owner's Manual .....	7
<b>FUNCTIONAL OVERVIEW</b> .....	<b>10</b>
Front Panel .....	10
Rear Panel .....	11
Remote Control .....	12
Front Panel Display .....	14

## Connections

<b>ANTENNA CABLE CONNECTION</b> .....	<b>15</b>
<b>RF MODULATOR CONNECTION</b> .....	<b>16</b>
<b>CONNECTION TO A CABLE / SATELLITE BOX</b> .....	<b>17</b>
<b>CONNECTION TO A TV</b> .....	<b>18</b>
<b>CONNECTION TO AN AUDIO SYSTEM</b> .....	<b>19</b>

## Basic Setup

<b>GUIDE TO ON-SCREEN DISPLAYS AND MENUS</b> ....	<b>20</b>
On-Screen Display / Menu .....	20
Main Menu .....	21
<b>INITIAL SETTING</b> .....	<b>22</b>
<b>CHANNEL SETTING</b> .....	<b>23</b>
Auto Channel Scan .....	23
Adding / Deleting Channels .....	24
<b>SETTING THE CLOCK</b> .....	<b>26</b>
Auto Clock Setting .....	26
Manual Clock Setting .....	27
Daylight Saving Time .....	27
<b>TUNER SETTINGS</b> .....	<b>28</b>
Switching Analog Mode / Digital Mode .....	28
Channel Selection .....	28
Selecting TV Audio .....	29
DTV Closed Caption .....	31
Closed Caption Style .....	32

## Disc Management

<b>FORMATTING A DISC</b> .....	<b>34</b>
Choosing the Recording Format of a Brand-New DVD-RW .....	34
Reformatting a Disc Manually .....	35
<b>PREPARING A DISC</b> .....	<b>36</b>
Setting for Auto Chapter .....	36
Setting Aspect Ratio for Video Mode Recording .....	36
<b>SETTING A DISC TO PROTECT</b> .....	<b>37</b>
<b>PLAYING THE DISCS IN OTHER DVD PLAYERS</b> .....	<b>38</b>
Auto Finalizing .....	38
Finalizing a Disc .....	39

## Recording

<b>INFORMATION ON DVD RECORDING</b> .....	<b>41</b>
Recording Speed .....	41
Restrictions on Recording .....	41
<b>BASIC RECORDING &amp; ONE-TOUCH TIMER RECORDING</b> .....	<b>42</b>
<b>TIMER RECORDING</b> .....	<b>44</b>
Hints for Timer Recording .....	47
<b>SETTINGS FOR AN EXTERNAL DEVICE</b> .....	<b>48</b>
Connection to an External Device .....	48
Recording from an External Device .....	49

## Playback

<b>INFORMATION ON PLAYBACK</b> .....	<b>50</b>
Structure of Disc Contents .....	50
<b>BASIC PLAYBACK</b> .....	<b>51</b>
Direct Playback .....	51
Playback from the Title List .....	52

Playing Back an Audio CD and a CD-RW/-R with MP3 / JPEG Files .....	53
Using the Title / Disc Menu .....	54
Pause .....	54
<b>SPECIAL PLAYBACK</b> .....	<b>55</b>
Resume Playback .....	55
Fast Forward / Fast Reverse Playback .....	55
Skipping TV Commercials During Playback .....	55
Rapid Playback .....	56
Step by Step Playback .....	56
Slow Forward / Slow Reverse Playback .....	56
Zoom .....	57
Marker Setting .....	57
<b>SEARCH</b> .....	<b>58</b>
Title/Chapter Search .....	58
Track Search .....	58
Time Search .....	59

## **REPEAT/RANDOM/PROGRAM PLAYBACK/**

<b>SLIDE SHOW</b> .....	<b>60</b>
Repeat Playback .....	60
Random Playback .....	60
Program Playback .....	61
Slide Show .....	61
<b>SELECTING THE FORMAT OF AUDIO AND VIDEO</b> ..	<b>62</b>
Switching Subtitles .....	62
Switching Audio Soundtrack .....	62
Switching Virtual Surround System .....	63
Switching Camera Angles .....	63
Reducing Block Noise .....	63

## Editing

<b>INFORMATION ON DISC EDITING</b> .....	<b>64</b>
Guide to a Title List .....	64
Editing Discs .....	64
<b>DELETING TITLES</b> .....	<b>65</b>
<b>CREATING/DELETING PLAYLIST</b> .....	<b>67</b>
Adding Titles to a Playlist .....	67
Erasing All Playlist .....	68
<b>EDITING DISCS</b> .....	<b>69</b>
Putting Names on Titles .....	69
Setting or Clearing Chapter Marks .....	71
Deleting a Part of a Title .....	72
Dividing a Title .....	74
Combining Titles .....	75
Setting or Releasing the Title Protection .....	76
Setting or Clearing All Chapter Marks at Once .....	77

## Function Setup

<b>LIST OF SETTINGS</b> .....	<b>78</b>
<b>SETUPS</b> .....	<b>80</b>
Playback .....	80
Display .....	84
Video .....	86
Reset All .....	88

## Others

<b>TROUBLESHOOTING</b> .....	<b>89</b>
Frequently Asked Questions .....	91
<b>LANGUAGE CODE</b> .....	<b>93</b>
<b>GLOSSARY</b> .....	<b>94</b>
<b>SPECIFICATIONS</b> .....	<b>95</b>

## Español

<b>ESPAÑOL</b> .....	<b>96</b>
----------------------	-----------

<b>LIMITED WARRANTY</b> .....	<b>Back cover</b>
-------------------------------	-------------------

# FEATURES

This unit not only plays back DVD and CD but also offers features for you to record on DVD and edit them after that. The following features are offered with this unit.

## Recording

This unit is compatible with recording on DVD-RW which is recordable repeatedly and DVD-R which accept the additional recordings until the disc becomes full but not over-writable. You can choose either one for your convenience.

### Up to 12 program recording:

You can program the unit to record up to 12 programs within a one-month period. Daily or weekly program recordings are also available.

### One-touch timer recording (OTR):

You can easily set a recording time as you prefer. Every time [REC/OTR] is pressed during recording, the recording time will be increased by 30 minutes up to 8 hours. The recording automatically stops when the recording time you set is reached.

### Automatic chapter mark setting:

Chapter marks will be put on recordings as you set before attempting to record.

### Automatic title menu making:

The unit creates title menu automatically when finalizing discs.

### Automatic playlist making (VR mode DVD-RW):

The unit creates a playlist automatically after recording.

### Automatic title finalizing (Video mode DVD-RW/-R):

You can finalize discs automatically after finishing all timer recordings or at the end of the disc space if you set this in the main menu.

### Left channel stereo recording:

This unit can record the sound of the left channel monaural input as left and right channels automatically (the input from the L2 jacks only).

## Playback

### Theater surround sound in your home:

When connecting the unit to an amplifier or a decoder which is compatible with Dolby Digital, you can experience the theater surround sound from discs with surround sound system.

### Quick search for what you want to watch:

You can easily find the part you want to watch using the search function. Search for a desired point on a disc by title, chapter/track or time.

### Virtual surround system:

You can enjoy stereophonic space through your existing 2 channel stereo system.

### Playing back MP3/JPEG/Kodak Picture CD files:

You can enjoy MP3/JPEG/Kodak Picture CD files which are recorded on CD-RW/-R.

## Editing

### Deleting titles:

You can delete titles which you do not need anymore.

### Setting or clearing chapter marks:

You can set or clear chapter marks on titles.

### Deleting parts of titles:

You can delete a specific part of a title.

### Dividing or combining titles:

You can divide or combine a title.

### Editing title names:

You can change the title name you prefer.

## Compatibility

### Available for playing back discs on a regular DVD player:

Recorded discs can be played back on regular DVD players, including computer DVD drives compatible with DVD-video playback.

## Others







### Progressive scan system

Unlike conventional interlace scanning, the progressive scan system provides less flickering and images in higher resolution than that of traditional television signals.

## Symbols Used in this Owner's Manual





To specify for what disc type each function is, we put the following symbols at the beginning of each item to operate.

\* DVD-R recorded in VR format or non compatible recording format are not playable.

Symbol	Description
<b>For Recording, Playing Back, and Editing</b>	
	Description refers to DVD-RW in video mode
	Description refers to DVD-RW in VR mode
	Description refers to DVD-R in video mode
<b>For Playback only</b>	
	Description refers to DVD-video
	Description refers to audio CD
	Description refers to CD-RW/-R with MP3 files
	Description refers to CD-RW/-R with JPEG files, including Kodak Picture CD files

If you do not find any of the symbols listed above under the function heading, the operation is applicable to all media.

# FEATURES











Discs for Recording, Playing back			
Disc type	DVD-RW		DVD-R
Logo			
Format	Can be formatted in VR or video mode		Automatically formatted in video mode
Icon	Video Mode	VR Mode	
			
Maximum record time	480 min (12cm) 144 min (8cm)	480 min (12cm) 144 min (8cm)	480 min (12cm) 144 min (8cm)
Recordable/playable versions	Ver.1.1,1.2 Ver.1.1/2× CPRM compatible Ver.1.2/4× CPRM compatible		Ver.2.0 Ver.2.0/4× Ver.2.0/8× Ver.2.0/16×
Compatibility	Playable on most DVD players. Finalization necessary. (DVD menu will be created)	Playable only on VR mode compatible unit. Finalization recommended.	Playable on most DVD players. Finalization necessary. (DVD menu will be created)



Available Features	Recording Features				
	Record TV programs	✓	✓	✓	
	Reuse by deleting the current contents	✓	✓		
	Record 16:9 size pictures	✓	✓	✓	
	Record copy-once programs		✓*		
	Create chapters at fixed intervals (auto chapter)	✓	✓	✓	
	Editing Features		Playlist	Original	
	Scene delete		✓	✓	
	Edit title name	✓	✓	✓	✓
	Create chapters wherever you like (chapter mark)		✓	✓	
Divide a title		✓			
Combine titles		✓			
Hide chapters					
Delete a title	✓	✓	✓	✓	
Create a playlist			✓		
Protect a title			✓		

✓ : Available      □ : Not available

\*CPRM compatible disc only.

# FEATURES

Discs for playing back				
Disc Type	DVD-VIDEO	CD-DA	CD-RW	CD-R
Logo			 	 
Icon				

Files for playing back		
Type of title	MP3	JPEG
Icon		
Media	CD-RW/-R	CD-RW/-R

 is a trademark of DVD Format/Logo Licensing Corporation.

## RW

DVD players with **COMPATIBLE** are capable of playing DVD-RW recorded in VR mode.

- Following discs are recommended for good recording quality and are proven to be compatible with this unit. However, depending on the media condition the unit may not read the disc properly.

Verbatim DVD-R 8x, DVD-RW 2x  
 JVC DVD-RW 4x  
 Maxell DVD-R 8x/16x

Performance of any other discs are not guaranteed.

## Unplayable Discs

The following discs will not play back on this unit.

- CD-ROM
- Compact Disc-Interactive (CD-I)
- Video Single Disc (VSD)
- DVD-ROM
- DVD-audio
- Unfinalized disc
- DVD contains MP3 or JPEG files
- DVD-R recorded in VR format or non compatible recording format

On the following disc, the sound may not be heard.

- Super audio CD - Only the sound on the CD layer can be heard. The sound on the high-density super audio CD layer cannot be heard.

## Color Systems

DVD is recorded in different color systems throughout the world. The most common color system is NTSC (which is used primarily in the United States and Canada). This unit uses NTSC, so DVD you play back must be recorded in the NTSC system. You cannot play back DVD recorded in other color systems.

## Region Codes

This unit has been designed to play back DVD with region 1. DVD must be labeled for ALL regions or for region 1 in order to play back on the unit. You cannot play back DVD that are labeled for other regions. Look for the symbols on the right on your DVD. If these region symbols do not appear on your DVD, you cannot play back the DVD in this unit.

The number inside the globe refers to region of the world. A DVD labeled for a specific region can only play back on the unit with the same region code.



# FUNCTIONAL OVERVIEW

## Front Panel

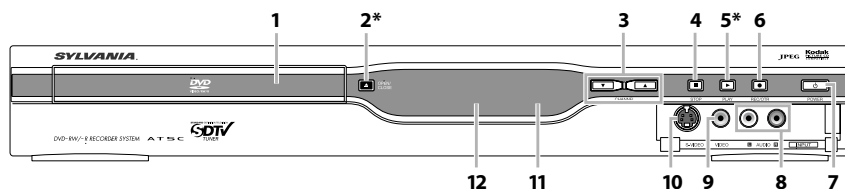

(\*) The unit can also be turned on by pressing these buttons.

**1. Disc tray**

Place a disc when the disc tray is opened.

**2. OPEN/CLOSE ▲ button\***

Press to open or close the disc tray.

**3. CHANNEL ▲ / ▼ buttons**

Press to change the channel up and down.

**4. STOP ■ button**

Press to stop playback or recording.

**5. PLAY ► button\***

Press to start or resume playback.

**6. REC/OTR ● button**

Press once to start a recording. Press repeatedly to start one-touch timer recording.

**7. POWER ○ button**

Press to turn the unit on and off.

If timer programmings have been set, press to set the unit in timer-standby mode.

**8. AUDIO input jacks (L2)**

Use to connect external device with a RCA audio cable.

**9. VIDEO input jack (L2)**

Use to connect external device with a RCA video cable.

**10. S-VIDEO input jack (L2)**

Use to connect the S-video output of external device with an S-video cable.

**11. Infrared sensor window**

Receive signals from your remote control so that you can control the unit from a distance.

**12. Display**

Refer to "Front Panel Display" on page 14.

## Rear Panel

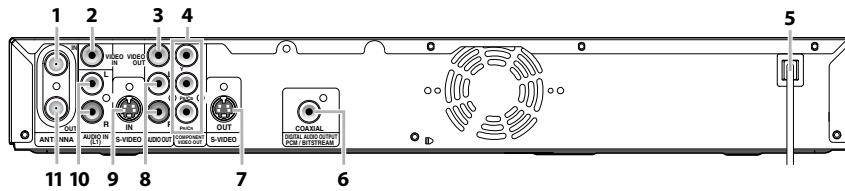

### 1. ANTENNA IN jack

Use to connect an antenna.

### 2. VIDEO IN jack (L1)

Use to connect external device with a RCA video cable.

### 3. VIDEO OUT jack

Use to connect a TV monitor, AV receiver or other device with a RCA video cable.

### 4. COMPONENT VIDEO OUTPUT jacks

Use to connect a TV monitor with component video inputs with a component video cable.

### 5. AC Power Cord

Connect to a standard AC outlet to supply power to this unit.

### 6. COAXIAL DIGITAL AUDIO OUTPUT jack

Use to connect an AV receiver, Dolby Digital decoder or other device with a digital audio coaxial input jack with a digital audio coaxial cable.

### 7. S-VIDEO OUT jack

Use to connect the S-video input of a TV monitor, AV receiver or other device with an S-video cable.

### 8. AUDIO OUT jacks

Use to connect a TV monitor, AV receiver or other device with a RCA audio cable.

### 9. S-VIDEO IN jack (L1)

Use to connect the S-video output of external device with an S-video cable.

### 10. AUDIO IN jacks (L1)

Use to connect external device with a RCA audio cable.

### 11. ANTENNA OUT jack

Use to connect an RF coaxial cable to pass the signal from the ANTENNA IN to your TV.

### Note

- Do not touch the inner pins of the jacks on the rear panel. Electrostatic discharge may cause permanent damage to the unit.
- This unit does not have the RF modulator.

# FUNCTIONAL OVERVIEW

## Remote Control

### Installing the Batteries in the Remote Control

Install the batteries (AAx2) matching the polarity indicated inside battery compartment of the remote control.

#### 1 Open the cover.

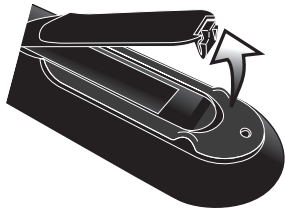

#### 2 Insert batteries.

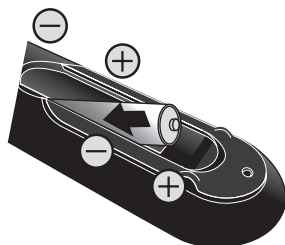

Make sure to match + and - on the batteries to the marks indicated in the battery compartment.

#### 3 Close the cover.

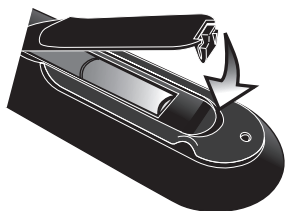

#### Caution:

Never throw batteries into a fire.

#### Note:

- Be sure to use AA size batteries.
- Dispose of batteries in a designated disposal area.
- Batteries should always be disposed of with the environment in mind. Always dispose of batteries in accordance with applicable laws and regulations.
- If the remote control does not operate correctly, or if the operating range becomes reduced, replace batteries with new ones.
- When necessary to replace batteries in the remote control, always replace both batteries with new ones. Never mix battery types or use new and used batteries in combination.
- Always remove batteries from remote control if they are dead or if the remote control is not to be used for an extended period of time. This will prevent battery acid from leaking into the battery compartment.

### Using a Remote Control

Keep in mind the following when using the remote control:

- Make sure that there are no obstacles between the remote control and the infrared sensor window on the unit.
- Remote operation may become unreliable if strong sunlight or fluorescent light is shining on the infrared sensor window of the unit.
- Remote control for different devices can interfere with each other. Avoid using remote control for other device located close to the unit.
- Replace the batteries when you notice a fall off in the operating range of the remote control.
- The maximum operable ranges from the unit are as follows.
  - **Line of sight:** approx. 23 feet (7m)
  - **Either side of the center:** approx. 16 feet (5m) within 30°
  - **Above:** approx. 16 feet (5m) within 15°
  - **Below:** approx. 10 feet (3m) within 30°



16 feet (5m)  
30°

23 feet (7m)

16 feet (5m)  
30°

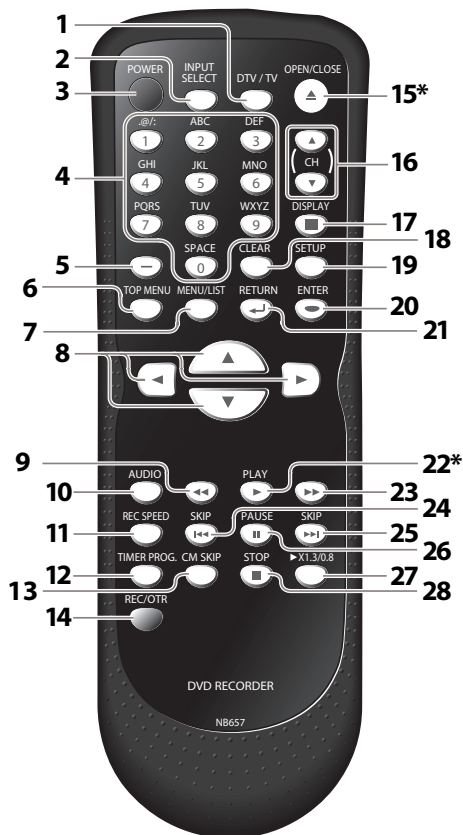

(\*) The unit can also be turned on by pressing these buttons.

## 1. DTV/TV button

Press to switch between digital TV (DTV) mode and analog TV (TV) mode.

## 2. INPUT SELECT button

Press to select the appropriate input.

## 3. POWER button

Press to turn the unit on and off. If timer programmings have been set, press to set the unit in timer-standby mode.

## 4. Number/Character buttons

- Press to select channel numbers.
- Press to select a title/chapter/track/file on display.
- Press to enter values for the settings in the main menu.
- Press to enter title names.

## 5. Confirm ( - ) button

**Analog mode:**

Press to confirm the channel selection made by [the Number buttons].

**Digital mode:**

Press to confirm the major / minor channel selection made by [the Number buttons].

## 6. TOP MENU button

Press to display the title list.

## 7. MENU/LIST button

Press to display the disc menu. To change original and playlist on the TV screen.

## 8. Cursor ▲ / ▼ / ◀ / ▶ buttons

Press to select items or settings.

## 9. REV ◀◀ button

- During playback, press to fast reverse playback.
- When playback is in pause, press to slow reverse playback.

## 10. AUDIO button

- Press to switch the audio language for digital TV.
- Press to display the audio menu during playback.

## 11. REC SPEED button

Press to switch the recording speed.

## 12. TIMER PROG. button

Press to display the timer programming list.

## 13. CM SKIP button

During playback, press to skip 30 seconds.

## 14. REC/OTR button

- Press once to start a recording.
- Press repeatedly to start the one-touch timer recording.

## 15. OPEN/CLOSE ▲ button\*

Press to open or close the disc tray.

## 16. CH ▲ / ▼ buttons

Press to change the channel up and down.

## 17. DISPLAY button

Press to display the display menu on or off.

## 18. CLEAR button

Press to clear the password once entered, to cancel the programming for CD, to clear the selecting marker number in the display menu, etc.

## 19. SETUP button

- Press to display the main menu.
- During DVD playback, press and hold for more than 3 seconds to switch the progressive scanning mode to the interlace mode.

## 20. ENTER button

Press to confirm or select menu items.

## 21. RETURN ↵ button

Press to return to the previously displayed menu screen.

## 22. PLAY ► button\*

Press to start playback or resume playback.

## 23. FWD ►► button

- During playback, press to fast forward playback.
- When playback is in pause, press to slow forward playback.

## 24. SKIP ◀◀ button

- During playback, press to return to the beginning of the current chapter, track or file.
- When playback is in pause, press repeatedly to reverse the playback step by step.

## 25. SKIP ►► button

- During playback, press to skip to the next chapter, track or file.
- When playback is in pause, press repeatedly to forward the playback step by step.

## 26. PAUSE || button

Press to pause playback or recording.

## 27. ►x1.3/0.8 button

During playback, press to play back in a slightly faster/slower while keeping the audio quality just as normal playback.

## 28. STOP ■ button

- Press to stop playback or recording.
- Press to exit from the title list.

# FUNCTIONAL OVERVIEW

## Front Panel Display

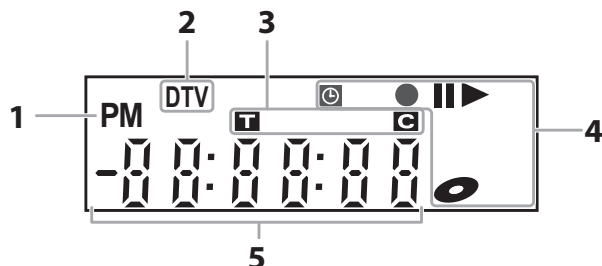

### 1.

**PM** : Appears in the afternoon with the clock display.

### 2.

**DTV** : Appears when the channel is in DTV mode.

### 3. Title / track / file and chapter mark

**T** : Appears when indicating a title / track / file number.

**C** : Appears when indicating a chapter number.

### 4. Current status of the unit

**||** : Appears when playback is paused.

**▶** : Appears when playing back a disc.

**⏰** : Appears when the timer programming or OTR has been set and is proceeding.

: Flashes when all timer recordings have been finished.

**●** : Appears during recording process.

: Flashes when a recording pauses.

**Ⓚ** : Appears when a disc is in this unit.

### 5. Displays the following

- Elapsed playback time
- Current title / chapter / track / file number
- Recording time / remaining time
- Clock
- Channel number
- Remaining time for one-touch timer recording

## Display Message



Appears when the disc tray is opening.



Appears when a disc is loaded on the disc tray.



Appears when the disc tray is closing.



Appears when data is being written on a disc.

# ANTENNA CABLE CONNECTION

This section describes how to connect your unit to an antenna, cable box, etc.

**1** Disconnect the power cord of your TV from the AC outlet.

**2** Disconnect RF coaxial cable from antenna input jack of your TV.

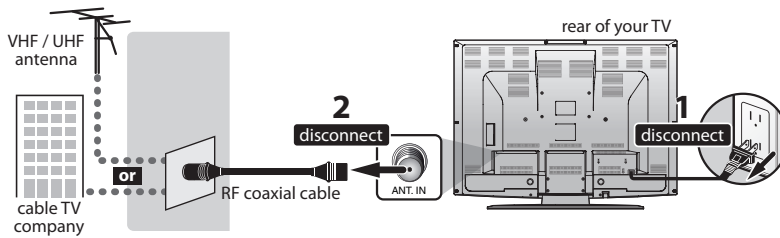

**3** Connect cables to the unit.  
Make the basic connection as illustrated below.

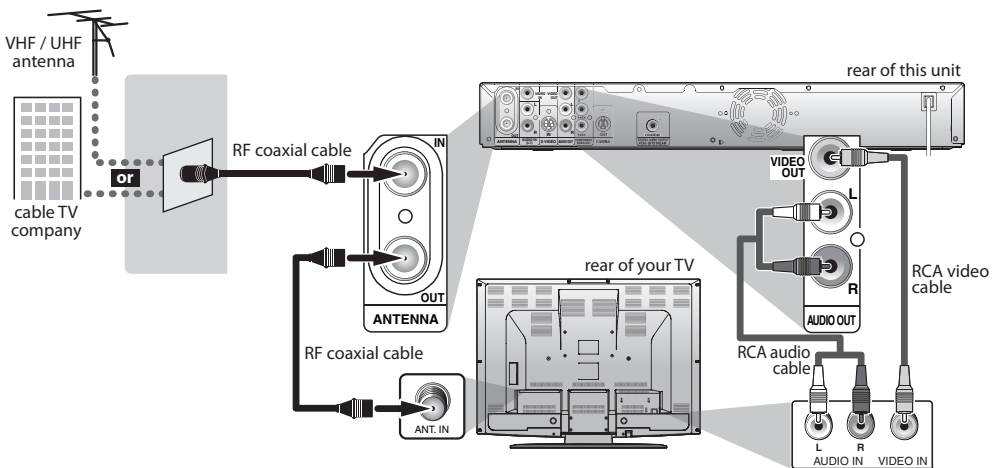

**4** Plug in the power cord of this unit and your TV to the AC outlet.

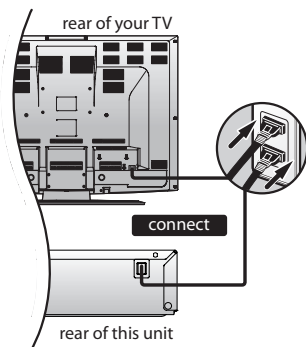

## Supplied cables used in this connection are as follows:

- RF coaxial cable x 1
- RCA audio cable (L/R) x 1
- RCA video cable x 1

Please purchase the rest of the necessary cables at your local store.

\*Once connections are completed, turn on the TV and initial setting begin.  
Channel scanning is necessary for the unit to memorize all available channels in your area.  
(Refer to "INITIAL SETTING" on page 22.)

## Note

- For your safety and to avoid damage to the device, please unplug the RF coaxial cable from the ANTENNA IN jack before moving the unit.
- If you use an antenna to receive analog TV, it should also work for DTV reception. Outdoor or attic antennas will be more effective than set-top versions.
- RF output is for tuner pass through only. DVD playback through the RF is not possible.

# RF MODULATOR CONNECTION

If your TV has antenna in jack only, it is still possible to connect this unit to your TV by using a stereo audio/video RF modulator. In this case, follow the instructions below.

- 1) Disconnect the power cords of the devices from the AC outlet.
  - 2) Make the connection as illustrated below.
  - 3) **Set your RF modulator's channel 3/4 switch to either 3 or 4**, whichever the TV channel is least used in your area. If your RF modulator has a Modulator/Antenna switch, set it according to the manual supplied with the RF modulator.
  - 4) Plug in the power cords of the devices to the AC outlet.
  - 5) **Turn on your TV and choose the same channel as you set the RF modulator's channel 3/4 switch.**
- For more details, follow the manual supplied with the RF modulator.

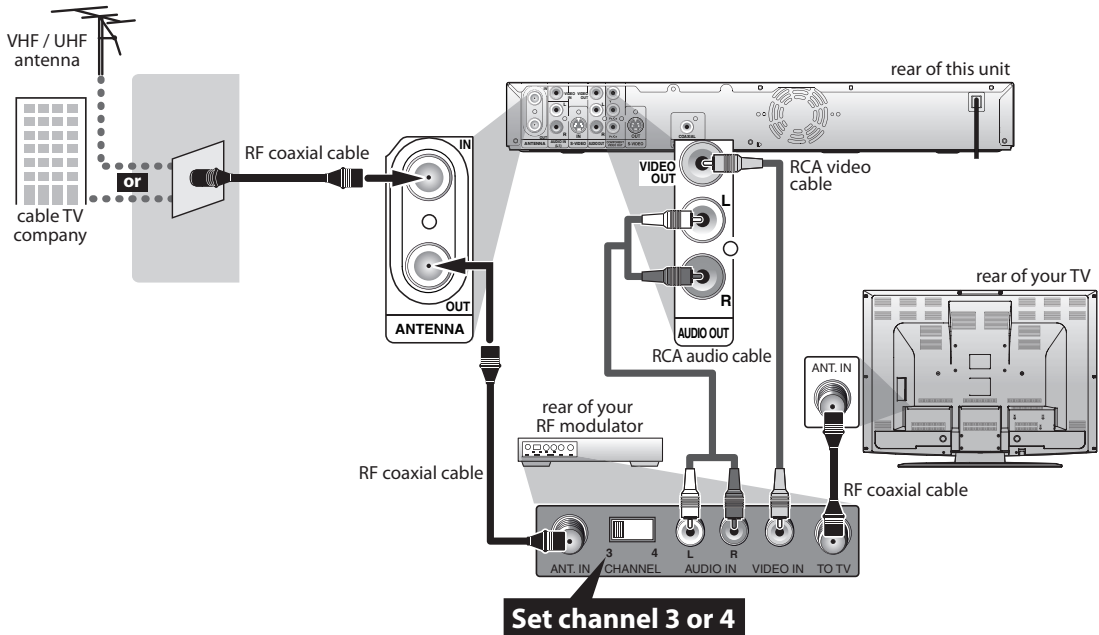

## Supplied cables used in this connection are as follows:

- RF coaxial cable x 1
- RCA audio cable (L/R) x 1
- RCA video cable x 1

Please purchase the rest of the necessary cables at your local store.

## Note

- The quality of picture may become poor if this unit is connected to an RF modulator.

# CONNECTION TO A CABLE / SATELLITE BOX

- 1) Disconnect the power cords of the devices from the AC outlet.
- 2) Make the connection as illustrated below.
- 3) Plug in the power cords of the devices to the AC outlet.

e.g.)

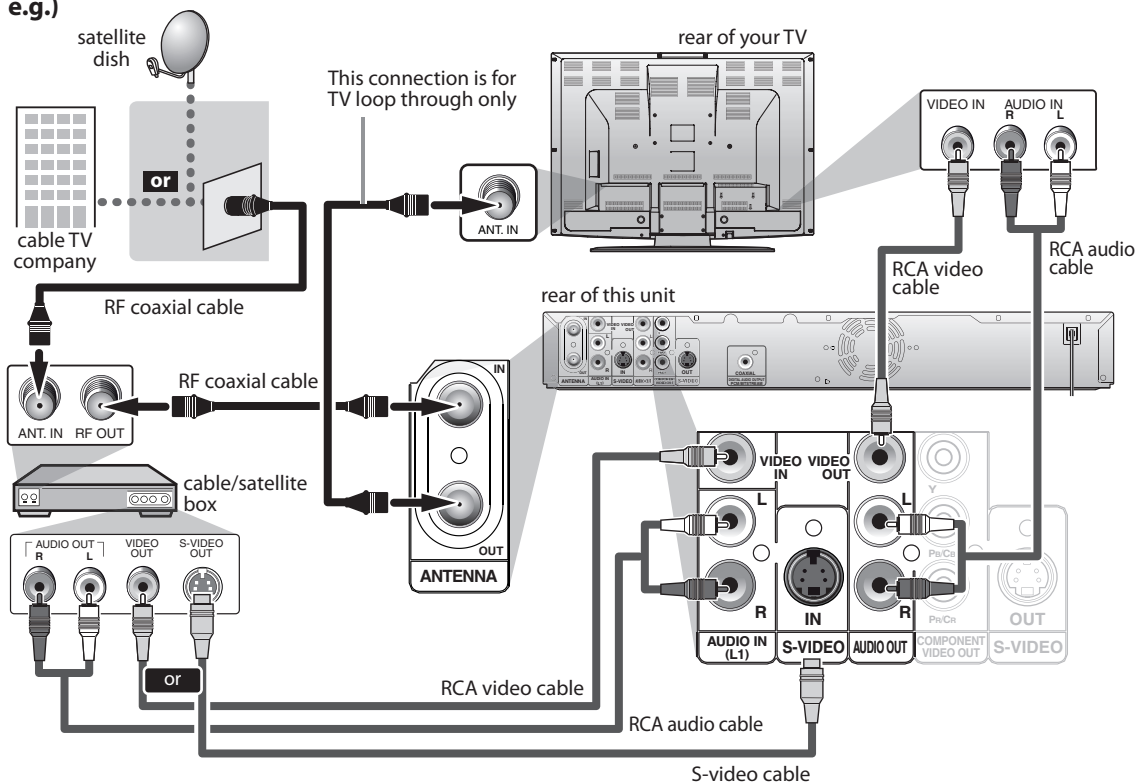

## Supplied cables used in this connection are as follows:

- RF coaxial cable x 1
- RCA audio cable (L/R) x 1
- RCA video cable x 1

Please purchase the rest of the necessary cables at your local store.

## Note

- Required cables and connecting methods differ depending on the cable/satellite box. For more information, please contact your cable/satellite provider.
- Instead of using VIDEO OUT jack of this unit, you can also use S-VIDEO OUT jack or COMPONENT VIDEO OUTPUT jack, for connecting to your TV.

## With this setup:

- You can record any unscrambled channel by selecting the channel on the cable/satellite box. Be sure that the cable/satellite box is turned on.
- **You cannot record one channel while watching another channel.**

## Note to CATV system installer

- This reminder is provided to call the cable TV system installer's attention to Article 820-40 of the National Electrical Code, which provides guidelines for proper grounding - in particular, specifying that the cable ground shall be connected to the grounding system of the building, as close to the point of cable entry as possible.

# CONNECTION TO A TV

Make one of the following connections, depending on the capabilities of your display device.

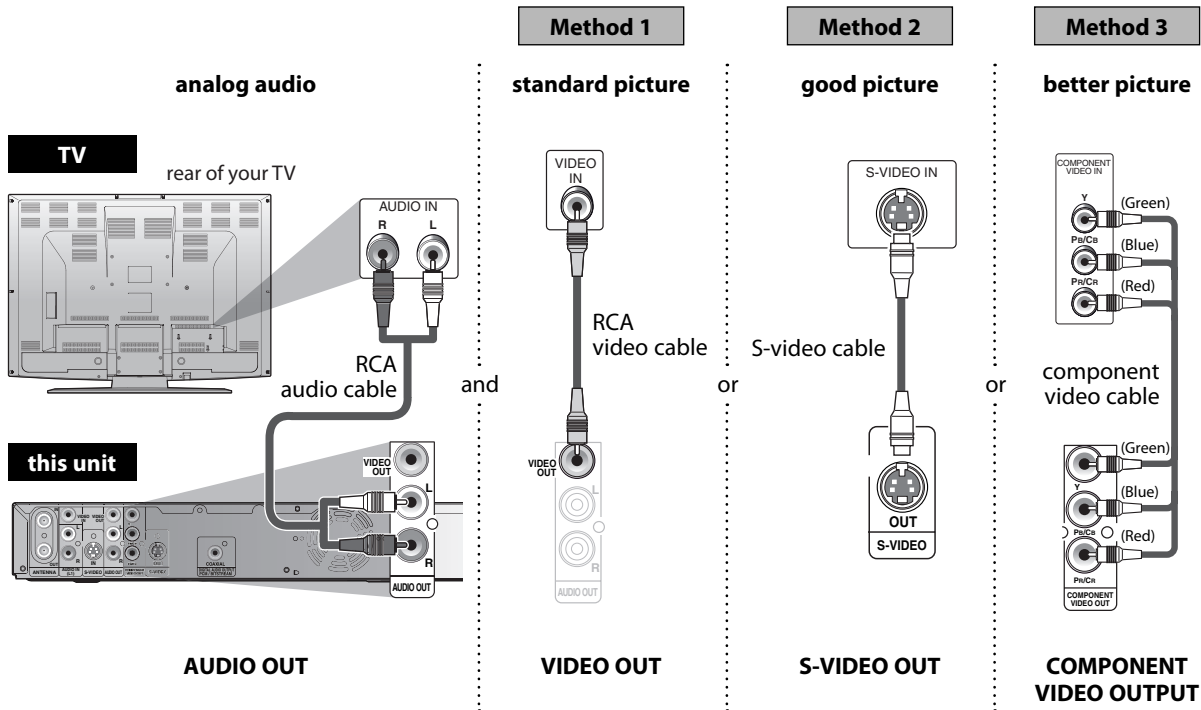

## Supplied cables used in this connection are as follows:

- RCA audio cable (L/R) x 1
- RCA video cable x 1

Please purchase the rest of the necessary cables at your local store.

## After you have completed the connections

- Switch the input selector on your TV to an appropriate external input channel. Press a button on the TV's original remote control that selects an external input channel until the DVD recorder's opening picture appears. Check your TV owner's manual for details.

## Note

- Connect this unit directly to the TV. If the RCA audio/video cables are connected to a VCR, pictures may be distorted due to the copy protection system.
- When "Progressive" is set to "ON", no video signal will be output from the VIDEO OUT or S-VIDEO OUT jack.

## To set progressive scan mode, refer to page 87

- This unit is compatible with the progressive scan system. The feature provides you the higher quality images than the traditional output system. To utilize this feature, you must set "Progressive" to "ON".

# CONNECTION TO AN AUDIO SYSTEM

- When you change the connections, all devices should be turned off.
- Refer to the manual accompanying external devices for more information.

## 2 Channel Analog Audio Connection

stereo system

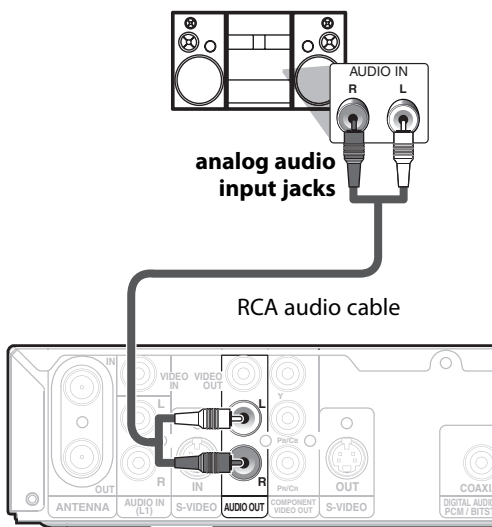

analog audio input jacks

RCA audio cable

AUDIO OUT

audio

this unit

## Digital Audio Connection

Dolby Digital decoder

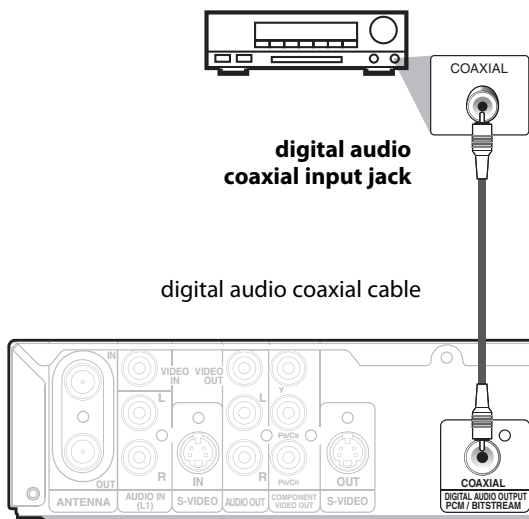

digital audio coaxial input jack

digital audio coaxial cable

DIGITAL AUDIO OUTPUT

\*MD deck or DAT deck can be also connected through coaxial jack.

### Supplied cables used in this connection are as follows:

- RCA audio cable (L/R) x 1
- Please purchase the rest of the necessary cables at your local store.

### Multi Channel Digital Audio Setting

Connection	Setting	Setup > General Setting > Playback > Audio Out > Dolby Digital
If output is Dolby Digital encoded audio, connect to a Dolby Digital decoder.		Stream
Connecting to an MD deck or DAT deck.		PCM
If not connected to any external devices.		PCM

\* To complete these settings, refer to page 82.

### Note

- The audio source on a disc in a Dolby Digital multi channel surround format cannot be recorded as digital sound by an MD or DAT deck.
- By connecting this unit to a Dolby Digital decoder, you can enjoy high-quality Dolby Digital multi channel surround sound as heard in the movie theaters.
- Playing back a DVD using incorrect settings may generate noise distortion and may also damage the speakers.

# GUIDE TO ON-SCREEN DISPLAYS AND MENUS

This unit uses the following on-screen displays and menus to guide you to the easy operations. The on-screen displays give you the information on the loaded disc, the disc/file in playback, etc. The menus allow you to change the various kinds of settings for playing back, recording, or editing to suite your preference.

## On-Screen Display / Menu

The on-screen display changes in the following order as you press [DISPLAY].

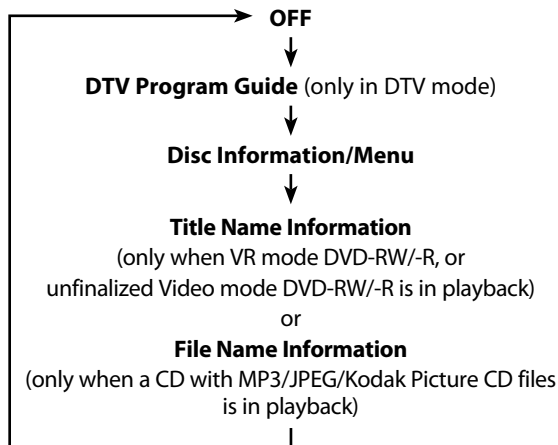

## DTV Program Guide

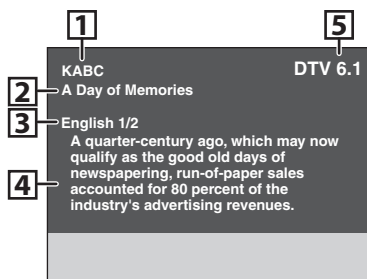

1. Broadcast station
2. Program title (max. 2 lines displayed)
3. Audio language ("Other" is displayed when the audio language cannot be acquired, or the acquired languages are other than English, Spanish or French.)
4. Program guide (max. 6 lines displayed)
5. Channel number

### Note

- When the program guide is displayed in more than 7 lines, use [▲ / ▼] to scroll.
- "No description provided" is displayed when the program guide is not provided.

## Disc Information / Menu

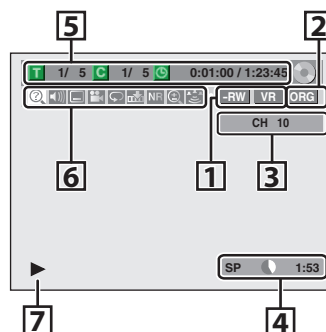

\* This is an example screen only for explanation.

1. Indicates a disc type and format mode.
2. Indicates a type of titles for VR mode DVD-RW .
3. Indicates a channel number or selected external input mode.
4. Indicates a recording speed and possible recording time left.
5. Indicates a title number, chapter number, elapsed time and total time of disc playback.
6. Each icon means:
 

: Search	: Marker
: Audio	: Noise Reduction
: Subtitle	: Zoom
: Angle	: Surround
: Repeat	
7. Indicates an operation status.

### Note

- In some descriptions on this manual, only one disc type is indicated as an example.

## Title/File Name Information

1. Displays title/file name.

Title name information

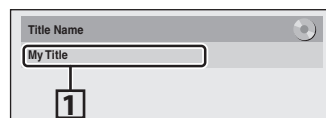

File name information

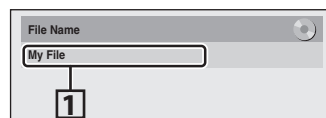

## Main Menu

Press [SETUP] to display the main menu. Then use [▲ / ▼] to select a menu and press [ENTER] to display the menu. These menus provide entries to all main functions of the unit.

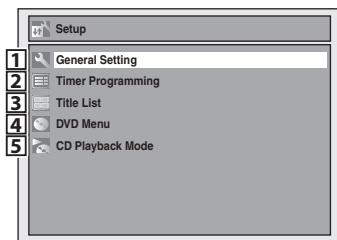

### 1. General Setting:

To go to general setting menu.

### 2. Timer Programming:

To program a timer recording.

### 3. Title List:

To call up the title list.

### 4. DVD Menu:

To set up the DVD setting.

### 5. CD Playback Mode:

To set up the CD playback setting.

- "CD Playback Mode" is available only when an audio CD, a CD-RW/-R with MP3 / JPEG / Kodak Picture CD files is inserted into the unit.

## General Setting Menu

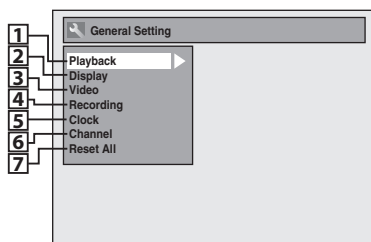

### 1. Playback:

To set up the unit to play back discs as you prefer.

### 2. Display:

To set up the OSD screen as you prefer.

### 3. Video:

To set up the video setting.

### 4. Recording:

To set up the unit to record to discs as you prefer.

### 5. Clock:

To set up the clock of the unit as you need.

### 6. Channel:

To adjust the channel setting of the unit as you prefer.

### 7. Reset All:

To reset the setting to the factory default.

## DVD Menu / CD Playback Mode

<DVD Menu menu>

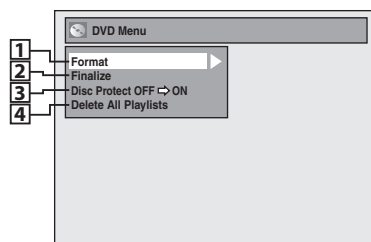

### 1. Format (DVD-RW only):

Allows you to format the disc.

### 2. Finalize:

Allows you to finalize a disc containing recorded titles.

### 3. Disc Protect (VR mode DVD-RW only):

Allows you to protect a disc from accidental editing or recording.

### 4. Delete All Playlists (VR mode DVD-RW only):

Allows you to delete playlist.

### 5. Random Play:

Allows you to activate the random playback feature.

### 6. Program Play: (Audio CD only)

Allows you to activate the program playback feature.

### 7. Slide Show: (JPEG / Kodak Picture CD files only)

Allows you to select the display time of the slide show mode.

<CD Playback Mode menu>

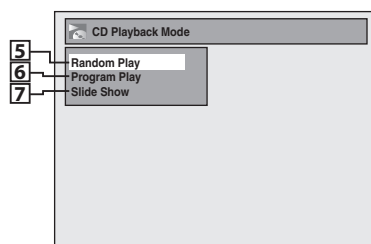

# INITIAL SETTING

You need to follow these steps when you turn on this unit for the first time.

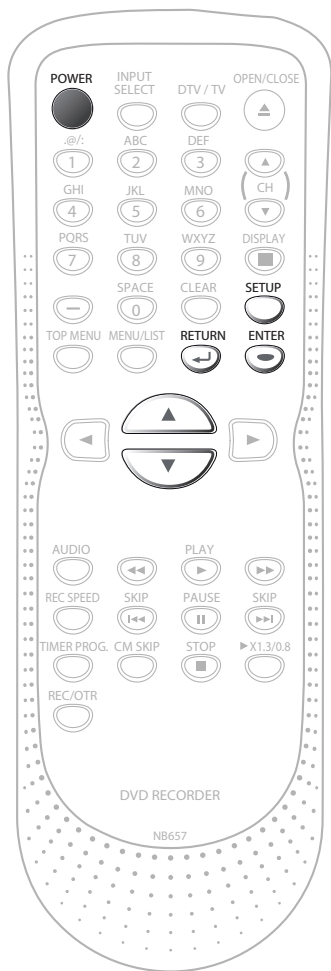

**1** Press [POWER].  
Turn on the TV. Select the input to which the unit is connected.

**2** Use [▲ / ▼] to select your desired language, then press [ENTER] to set language.

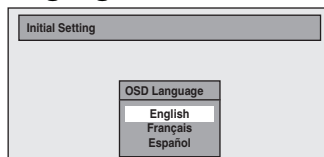

**3** Use [▲ / ▼] to select the type of broadcasting signal, then press [ENTER].

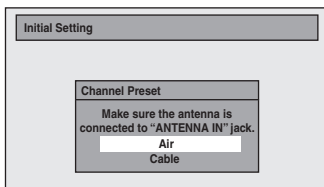

The unit will start getting channels available in your area.

**Air:**

(When using antenna)  
The channels broadcasted in TV and DTV are automatically scanned and memorized. Only the receivable channels in the area where this TV is used will be memorized.

**Cable:**

(When using basic cable)  
The channels broadcasted in CATV are automatically scanned and memorized.

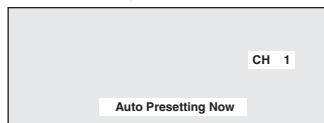

**To cancel the auto channel preset during scanning:**

Press [RETURN ←] or [SETUP] to cancel.

**4** Press [ENTER] to activate "Clock Setting".

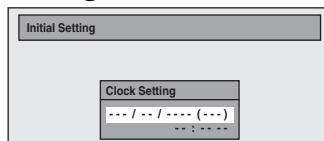

**5** Proceed to step 5 in "Manual Clock Setting" on page 27.

- If a PBS (public broadcasting station) is available in your area, press [RETURN ←] or [SETUP] to exit, then follow "Auto Clock Setting" on page 26.

# CHANNEL SETTING

If you have changed antenna connection, we recommend that you program available channels in your area with the following procedures.

## Auto Channel Scan

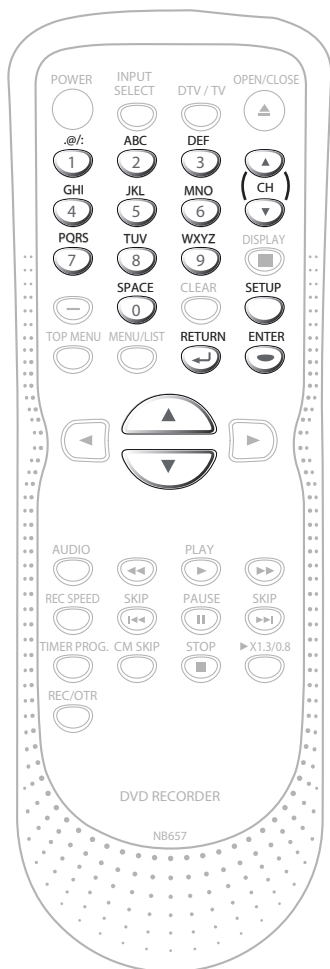

**1** Press [SETUP] and use [▲ / ▼] to select "General Setting", then press [ENTER].

**2** Use [▲ / ▼] to select "Channel", then press [ENTER].  
"Channel" menu will appear.

**3** Use [▲ / ▼] to select "Auto Preset", then press [ENTER].

**4** Use [▲ / ▼] to select the type of broadcasting signal, then press [ENTER].

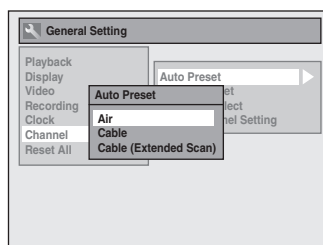

The unit will start getting channels available in your area.

**To cancel the auto channel preset during scanning:**

Press [RETURN ←] or [SETUP] to cancel.

**5** When scanning is over, press [SETUP] to exit.

To cycle through only the memorized channels, use [CH ▲ / ▼].

To select a channel directly (including the ones not memorized), use [the Number buttons].

### Note

- If the auto channel preset is canceled during presetting, some channels not yet preset may not be received.
- The selection will depend on how you receive the TV channels.

# CHANNEL SETTING

## Adding / Deleting Channels

You may want to add or delete TV channels if your channel lineup changes or if you no longer watch some channels.

**Adding channels is only available for the analog TV channels.**

### Make sure

- You perform "Auto Channel Scan" before adding or deleting the channels.

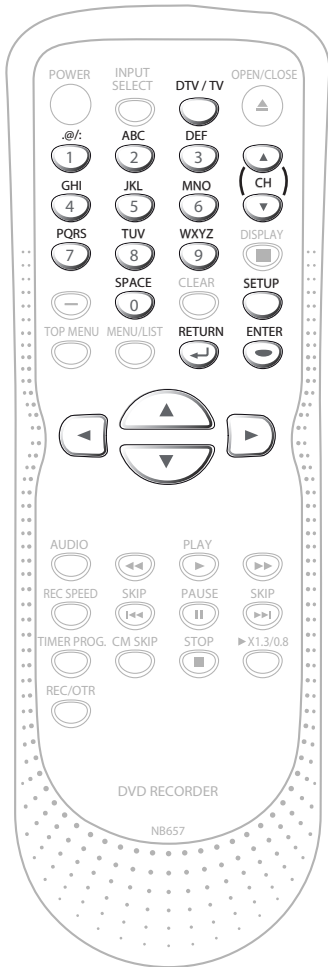

- 1** Press [DTV/TV] to select the mode (DTV or TV) to/from which you want to add or delete channels.
- 2** Press [SETUP] and use [▲ / ▼] to select "General Setting", then press [ENTER].
- 3** Use [▲ / ▼] to select "Channel", then press [ENTER].  
"Channel" menu will appear.
- 4** Use [▲ / ▼] to select "Manual Preset", then press [ENTER].  
"Manual Preset" menu will appear.
  - If you are adding or deleting analog TV channels, go to **ANALOG** on page 25 to continue.
  - If you are deleting digital TV channels, go to **DIGITAL** on page 25 to continue.

## ANALOG

### 5 Select the channel number to add or delete.

- Use [CH ▲ / ▼] to cycle through only the memorized channels.
- Use [◀ / ▶] to cycle through all the channels including the ones not memorized.
- Use [the Number buttons] to select a channel directly.
- When a memorized channel is selected, "Add" is checked and highlighted as a default.
- When an unmemorized channel is selected, "Delete" is checked and highlighted as a default.

### 6 Use [▲ / ▼] to select "Add" or "Delete", then press [ENTER].

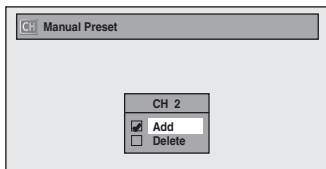

Your setting will be activated and it will automatically switch to the next channel so that you can continue adding or deleting channels.

### 7 Press [SETUP] to exit.

## DIGITAL

### 5 Select the channel number to delete.

- Only the major channel is displayed in "Manual Preset" menu. (The channel number displayed in the parenthesis is a virtual channel number)
- Use [CH ▲ / ▼] to cycle through only the memorized channels.
- You cannot use [◀ / ▶] for the digital TV channel selection.
- Use [the Number buttons] to select a channel directly.
- When an unmemorized channel is selected "Delete" is checked and highlighted as a default.

### 6 Use [▲ / ▼] to select "Delete", then press [ENTER]. Then select the next channel to delete.

- If the setting is complete, press [RETURN ↵] to activate "Manual Preset".

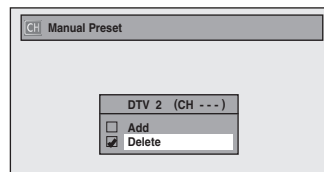

Your setting will be activated.

#### WARNING:

- For the digital TV channels, you cannot recover the deleted channels once they are deleted unless you perform the auto channel preset again.

### 7 Press [SETUP] to exit.

# SETTING THE CLOCK

Set the clock before you try the timer programming. If a PBS (public broadcasting station) is available in your area, follow "Auto Clock Setting" below. If not, follow "Manual Clock Setting" on page 27.

## Auto Clock Setting

This unit can set the time and date automatically by referring to a PBS station.

### Make sure

- The antenna/cable TV connections are correct.
- Channels are set. (Refer to page 23.)
- If this unit is connected to a cable/satellite box, select the local PBS station on them to set the clock automatically.

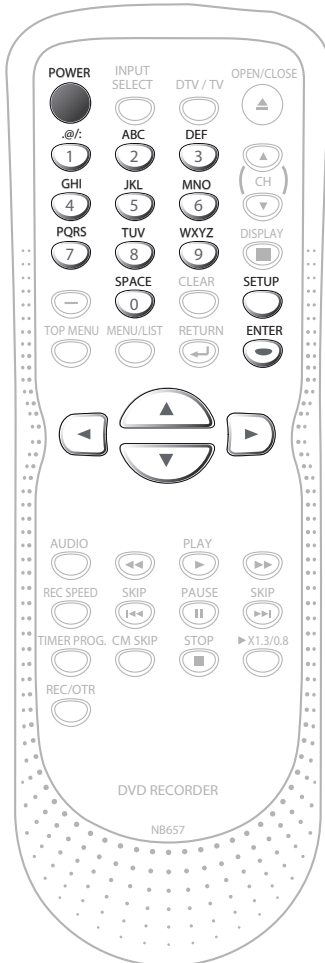

**1** Press [SETUP] and use [▲ / ▼] to select "General Setting", then press [ENTER].

**2** Use [▲ / ▼] to select "Clock", then press [ENTER].  
"Clock" menu will appear.

**3** Use [▲ / ▼] to select "Auto Clock Setting", then press [ENTER].

**4** Use [▲ / ▼] to select "Auto", then press [ENTER].

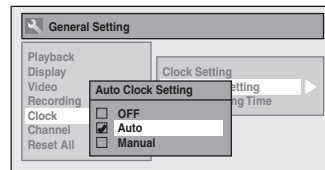

**5** Press [SETUP] to exit.

**6** Press [POWER] to turn off the unit.  
This unit will search for the time only when the power is off. Leave it off for several minutes to give this unit time to set the clock.

If the unit chooses an incorrect PBS channel, set the PBS channel manually by following the steps below.

**1** Select "Manual" at step 4, then press [ENTER].

**2** Use [the Number buttons] or [▲ / ▼] to enter your PBS channel number, then press [ENTER].

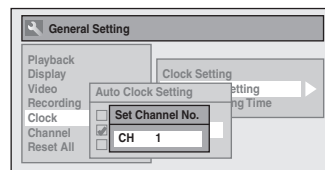

**3** Press [SETUP] to exit and turn off the unit.

### Note

- The unit receives the clock data at 12:00 a.m/p.m from the PBS channel when the power is off.
- The clock may set itself automatically after this unit receive the antenna/cable signal and plug in the power cord.
- Only the analog PBS channel signal is effective for auto clock setting.

# SETTING THE CLOCK

## Manual Clock Setting

**1** Press [SETUP] and use [▲ / ▼] to select "General Setting", then press [ENTER].

**2** Use [▲ / ▼] to select "Clock", then press [ENTER].  
"Clock" menu will appear.

**3** Use [▲ / ▼] to select "Clock Setting", then press [ENTER].

**4** Use [▲ / ▼] to select calendar or time, then press [ENTER].

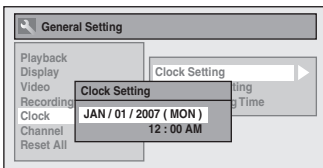

**5** Use [◀ / ▶] to select an item to set, and use [▲ / ▼] to select the contents to suit your preference, then press [ENTER].

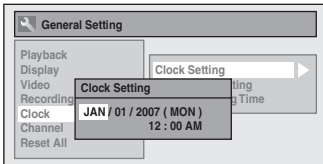

Your setting will be activated.  
The clock start counting when you press [ENTER].

**6** Press [SETUP] to exit.

## Daylight Saving Time

When "Daylight Saving Time" is "ON", the unit clock will automatically adjust the time in order to fit the daylight saving time.  
"ON (MAR - NOV)" has been selected as the default.

**1** Press [SETUP] and use [▲ / ▼] to select "General Setting", then press [ENTER].

**2** Use [▲ / ▼] to select "Clock", then press [ENTER].  
"Clock" menu will appear.

**3** Use [▲ / ▼] to select "Daylight Saving Time", then press [ENTER].

**4** Use [▲ / ▼] to select "ON (MAR - NOV)", "ON (APR - OCT)" or "OFF", then press [ENTER].

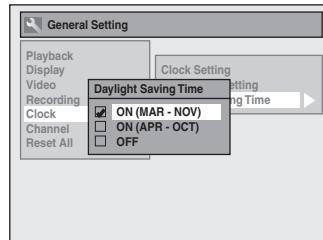

### ON (MAR - NOV):

Move forward one hour on the second Sunday in March and move back one hour on the first Sunday in November.

### ON (APR - OCT):

Move forward one hour on the first Sunday in April and move back one hour on the last Sunday in October.

**5** Press [SETUP] to exit.

### Note

- Your clock setting will be lost if either there is a power failure or this unit has been unplugged for more than 30 seconds when you set the clock manually.
- For setting the day, year, hour and minute, [the Number buttons] can also be used.
- You can set the built-in calendar from the year 2007 up to 2056.

# TUNER SETTINGS

## Switching Analog Mode / Digital Mode

You can easily switch the analog TV (NTSC) and digital TV (ATSC) with the remote control. For digital TV, enjoy viewing the HDTV (high definition TV) programs as well as the SDTV (standard definition TV) programs.

Press **[DTV/TV]** on the remote control.

- The analog mode and digital mode switch alternately.

### Note

- When you switch the analog mode to the digital mode, it may take awhile until the digital channel selection is completed. The following screen is displayed while switching the mode.



## Channel Selection

Select channels by using **[CH ▲ / ▼]** or **[the Number buttons]** on remote control.

**[CH ▲ / ▼]**

Use **[CH ▲ / ▼]** to change the channel.

**[the Number buttons]**

Press the channel number with **[the Number buttons]** to select a channel you want to watch.

**<Analog TV channels>**

Enter the channel number with **[the Number buttons]** to select a channel you want to watch.

**For 1-digit number**

e.g.) 2 ch: **[0] + [2], [2] + [-]** or **[2] + leave it for 2 seconds.**

**For 2-digit number**

e.g.) 12ch: **[1] + [2]**

**<Digital TV channels>**

Enter the major and minor channel number with **[the Number buttons]** to select a channel you want to watch.

**For 1-digit number**

e.g.) 2-2 ch:

major channel **[0] + [2] or [2] + [-]**

minor channel **[0] + [2], [2] + [-] or**

**[2] + leave it for 2 seconds.**

**For 2-digit number**

e.g.) 35-16ch:

major channel **[3] + [5]**

minor channel **[1] + [6]**

- If you enter 1 digit for major channel and leave it for 2 seconds, the number will be taken as the major channel and lowest minor channel of the major channel will be displayed.
- If there is no minor channel input, lowest minor channel of the major channel will be displayed.

### Note

- It may take up to 5 to 7 seconds to switch the digital TV channels.
- In digital TV broadcasting, 2 or more channels, called minor channels, are simultaneously broadcast on one main channel, called major channel.

**About digital TV broadcasting:**

With its high definition broadcast, digital broadcasting far surpasses analog broadcasting in both its picture and sound quality.

**What is the minor channel?**

By using high compression technology, digital broadcasting offers a service that enables multiple signals to send simultaneously.

Therefore, you can select more than one program per major channel since digital broadcasting technology distinguishes between multiple channels broadcast by a signal network.

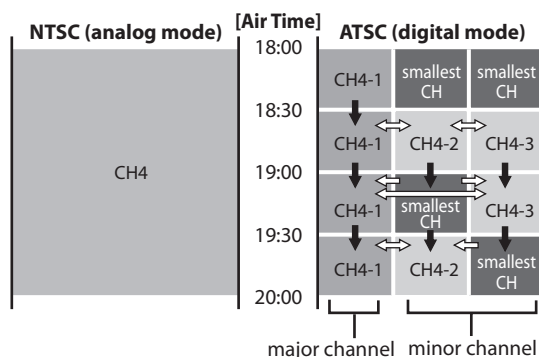

➔ : change automatically

⇔ : change manually by using **[CH ▲ / ▼]**

# TUNER SETTINGS

This section describes how to switch the TV audio.

When you record a TV program, only the audio selected here will be recorded.

(When recording an analog TV program to VR mode DVD-RW, both main and sub audio channels will be recorded.)

## Selecting TV Audio

### Digital TV

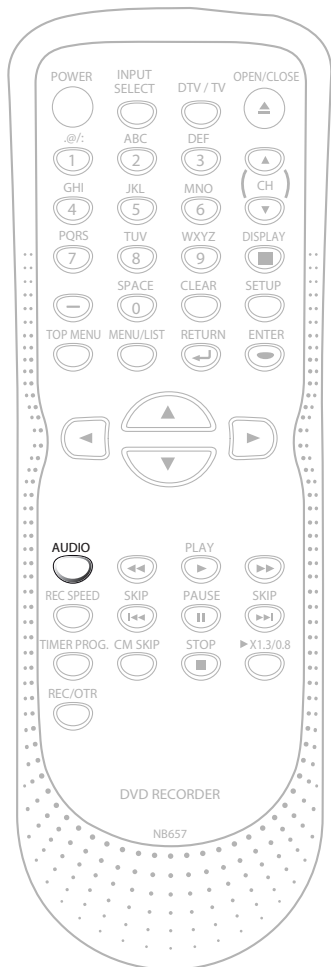

# 1

Press **[AUDIO]** to cycle through available audio languages.

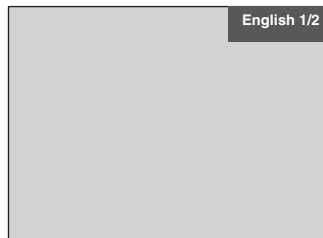

- When you press **[AUDIO]**, selected language will be displayed on the TV screen.
- Every time you press **[AUDIO]**, the language will be switched.  
e.g.) English 1/3 → Spanish 2/3 → Other 3/3
- Available languages differ depending on the broadcast.
- The information display will automatically disappear.
- When you record digital TV broadcasting, the audio language you have selected will be recorded.

### Note

- The timer recording for digital TV cannot record any audio language other than English.
- **[AUDIO]** does not control external device audio.
- When there is only one audio channel on the broadcast, pressing **[AUDIO]** does not display anything.

# TUNER SETTINGS

## Selecting TV Audio (cont'd)

### Analog TV

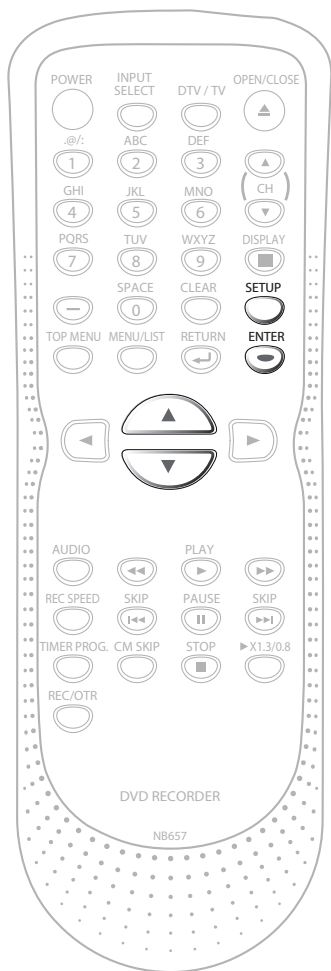

**1** Press [SETUP] and use [▲ / ▼] to select "General Setting", then press [ENTER].

**2** Use [▲ / ▼] to select "Channel", then press [ENTER].  
"Channel" menu will appear.

**3** Use [▲ / ▼] to select "TV Audio Select", then press [ENTER].

**4** Use [▲ / ▼] to select "Stereo" or "SAP", then press [ENTER].

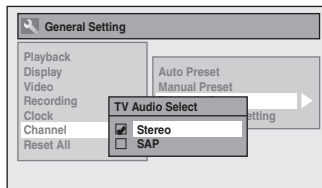

**Stereo:**

Outputs main-audio.

**SAP (secondary audio program):**

Outputs sub-audio.

**5** Press [SETUP] to exit.

**Note on recording analog TV channel audio**

- When you record an analog TV program available in second audio or stereo, you have to select either "Stereo" or "SAP" in "Channel" menu beforehand. Refer to the following table to check an appropriate setting.

Selected audio	Broadcast audio	Disc recording	Audio output
Stereo	STEREO+SAP	STEREO	STEREO
	STEREO	STEREO	STEREO
	MONO+SAP	MONO	MONO
	MONO	MONO	MONO
SAP	STEREO+SAP	SAP	SAP
	STEREO	STEREO	STEREO
	MONO+SAP	SAP	SAP
	MONO	MONO	MONO

# TUNER SETTINGS

## DTV Closed Caption

### Digital TV

Apart from closed captions, Digital TV has its own closed captions called DTV CC. Use this menu to change the settings for DTV CC.

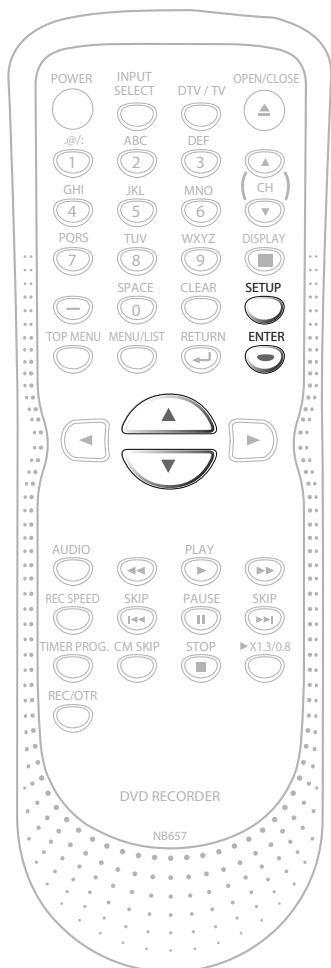

**1** Press [SETUP] and use [▲ / ▼] to select “General Setting”, then press [ENTER].

**2** Use [▲ / ▼] to select “Display”, then press [ENTER].

**3** Use [▲ / ▼] to select “CC Style”, then press [ENTER].

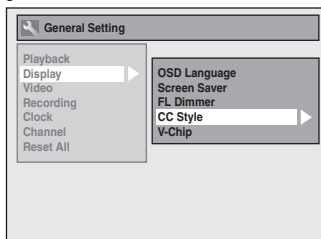

**4** Use [▲ / ▼] to select “DTV CC”, then press [ENTER].

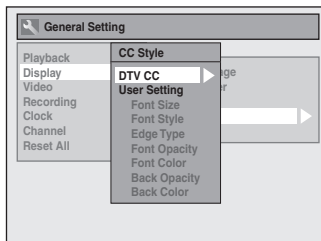

**5** Use [▲ / ▼] to the desired DTV closed caption, then press [ENTER].

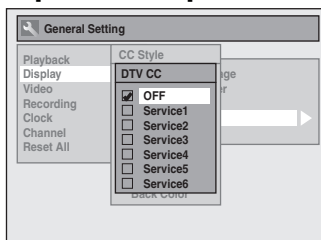

#### OFF:

Select if you do not want DTV CC. This is the default.

#### Service 1 to Service 6:

Select one of these before changing any other item in the closed caption menu. Choose “Service 1” under normal circumstances.

**6** Press [SETUP] to exit.

#### Note

- Even if you set “DTV CC” to anything other than “OFF”, its effect will temporarily be canceled while recording.

# TUNER SETTINGS

## Closed Caption Style

### Digital TV

Digital TV can also change the style of its closed caption such as font, color or size, etc.

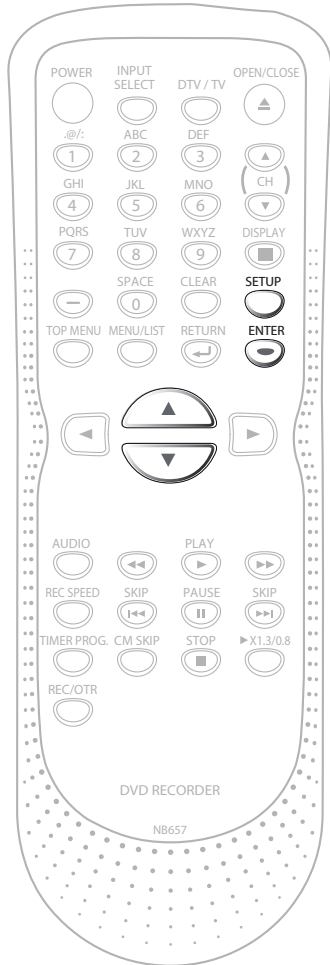

**1** Press [SETUP] and use [▲ / ▼] to select “General Setting”, then press [ENTER].

**2** Use [▲ / ▼] to select “Display”, then press [ENTER].

**3** Use [▲ / ▼] to select “CC Style”, then press [ENTER].

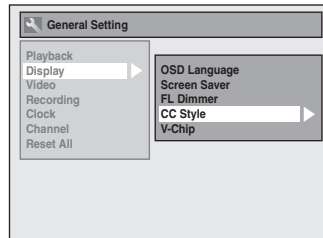

**4** Use [▲ / ▼] to select “User Setting”, then press [ENTER].

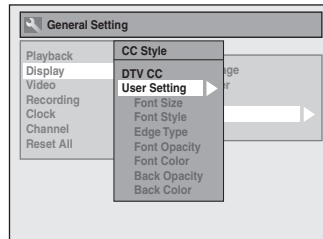

**5** Use [▲ / ▼] to select “ON”, then press [ENTER].

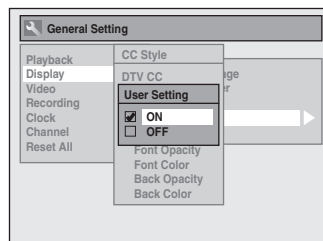

## 6 Use [▲ / ▼] to select the item and switch the setting for each item you want to set, then press [ENTER].

- When "User Setting" is set to "ON", you can set the following items. CC style set by "User Setting" will be displayed.
- The setting description for each item is shown below.

### <Font Size>

Font size of the displayed caption can be switched as below.

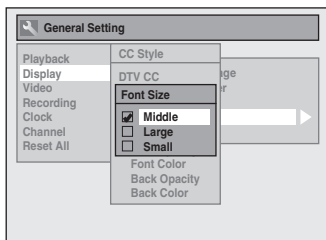

### <Font Style>

Font style of the displayed caption can be switched as below.

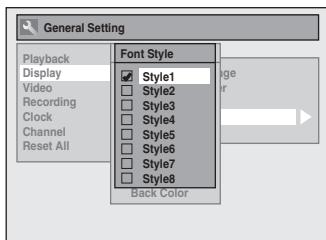

### <Edge Type>

Edge type of the displayed caption can be switched as below.

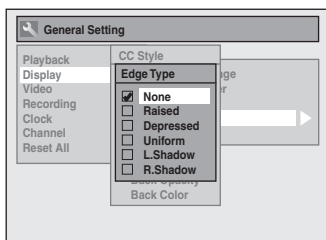

### <Font Opacity>

Font opacity of the displayed caption can be switched as below.

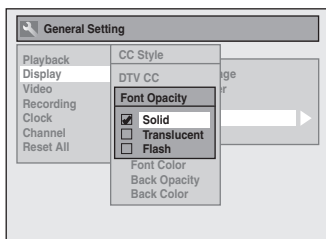

### <Font Color>

Font color of the displayed caption can be switched as below.

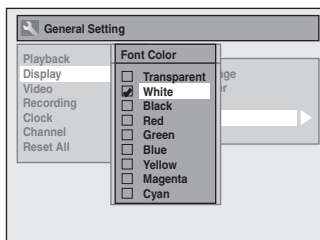

### <Back Opacity>

Background opacity of the displayed caption can be switched as below.

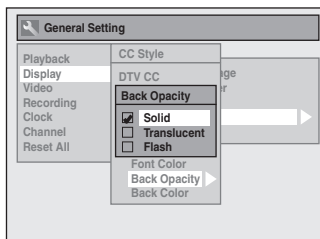

### <Back Color>

Background color of the displayed caption can be switched as below.

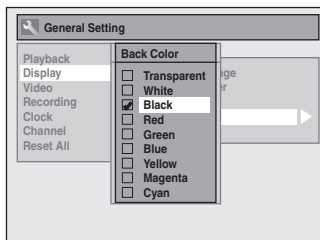

## 7 Press [SETUP] to exit.

# FORMATTING A DISC

## Choosing the Recording Format of a Brand-New DVD-RW



When inserting a brand-new DVD-RW, the unit automatically starts to initialize the disc.

DVD-RW will be formatted either video or VR mode according to the recording format mode setting of the unit. Before insert a brand-new DVD-RW, you need to set the recording format to the desired mode. You can also manually format a DVD-RW once it has been used.

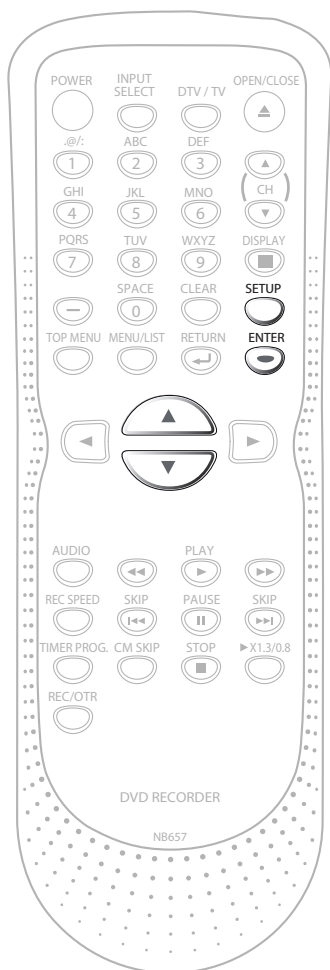

**1** Press [SETUP].

**2** Use [▲ / ▼] to select “DVD Menu”, then press [ENTER].

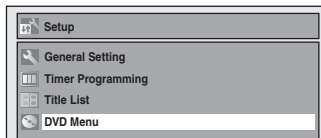

**3** Use [▲ / ▼] to select “Format”, then press [ENTER].

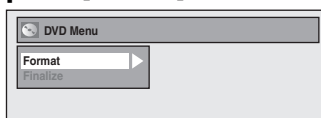

**4** Use [▲ / ▼] to select “Format Mode”, then press [ENTER].

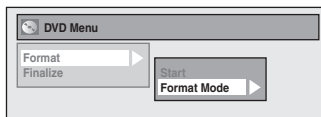

**5** Use [▲ / ▼] to select “Video mode” or “VR mode”, then press [ENTER].

**6** Press [SETUP] to exit.

**7** Insert a brand-new disc.  
Formatting will start.



**8** Formatting is completed.  
“100%” is indicated.

### Note

- The recording format setting is effective only for DVD-RW. You cannot change the recording format for a DVD-R.
- You cannot mix 2 formats on one DVD-RW. If you insert a disc that has been recorded before, the recording format cannot be changed even if you change it in the main menu.

## Reformatting a Disc Manually



If you are using a DVD-RW, you can format the disc by performing "Format". You can format DVD-RW for either video mode recording or VR mode recording.

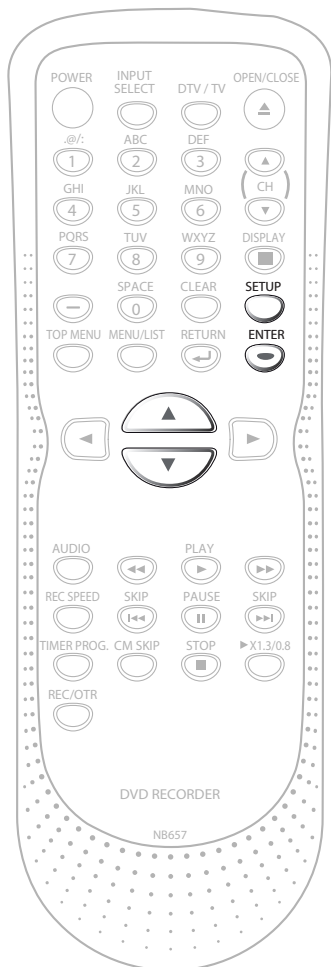

Insert a recordable disc.

**1** Press [SETUP].

**2** Use [▲ / ▼] to select "DVD Menu", then press [ENTER].

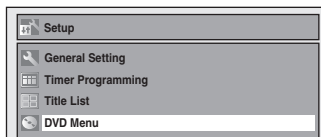

**3** Use [▲ / ▼] to select "Format", then press [ENTER].  
e.g.) VR mode DVD-RW



**4** Use [▲ / ▼] to select "Start", then press [ENTER].

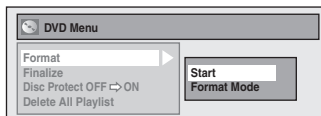

Selection menu will appear and prompt you to confirm.

**5** Use [▲ / ▼] to select "Yes", then press [ENTER].

Formatting will start.

If you want to cancel formatting, select "No".

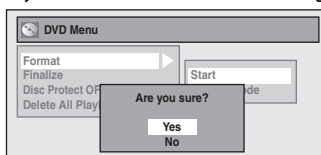

**6** Formatting is completed.  
"100%" is indicated.



### Note

- When you reformat the disc, the contents of the disc are erased.
- For DVD-RW, make sure that the recording format is set to the desired mode. (See steps 1 to 6 in "Choosing the Recording Format of a Brand-New DVD-RW" on page 34.)

# PREPARING A DISC

## Setting for Auto Chapter

You can set a specified time for chapter marks.

- 1) Press [SETUP] and use [▲ / ▼] to select “General Setting”, then press [ENTER].
- 2) Use [▲ / ▼] to select “Recording”, then press [ENTER].  
“Recording” menu will appear.
- 3) Use [▲ / ▼] to select “Auto Chapter”, then press [ENTER].
- 4) Use [▲ / ▼] to select a desired time option, then press [ENTER].

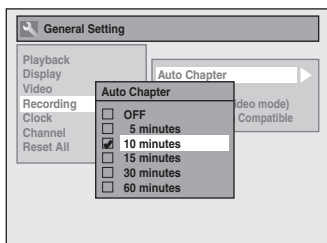

- 5) Press [SETUP] to exit.

### Note

- The interval for auto chapter marks may slightly differ.
- A blank chapter may be created depending on the remaining time of the disc.

## Setting Aspect Ratio for Video Mode Recording



You can set aspect ratio for video mode recording.

- 1) Press [SETUP] and use [▲ / ▼] to select “General Setting”, then press [ENTER].
- 2) Use [▲ / ▼] to select “Recording”, then press [ENTER].  
“Recording” menu will appear.
- 3) Use [▲ / ▼] to select “Aspect Ratio (Video mode)”, then press [ENTER].
- 4) Use [▲ / ▼] to select your desired setting, then press [ENTER].

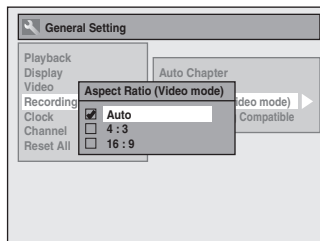

**Auto (default):** It will be recorded with whichever the ratio that the program you started to record are broadcasted with.

**4:3 :** Recorded in the aspect ratio of 4:3.

**16:9 :** Recorded in the aspect ratio of 16:9.

- 5) Press [SETUP] to exit.

### Note

- For DVD-RW VR mode, the image will be recorded in whichever the ratio that the program you record are broadcasted with, regardless of the “Aspect Ratio (Video mode)” setting.

# SETTING A DISC TO PROTECT



To prevent accidental recording, editing or erasing the titles, you can protect them from "DVD Menu".

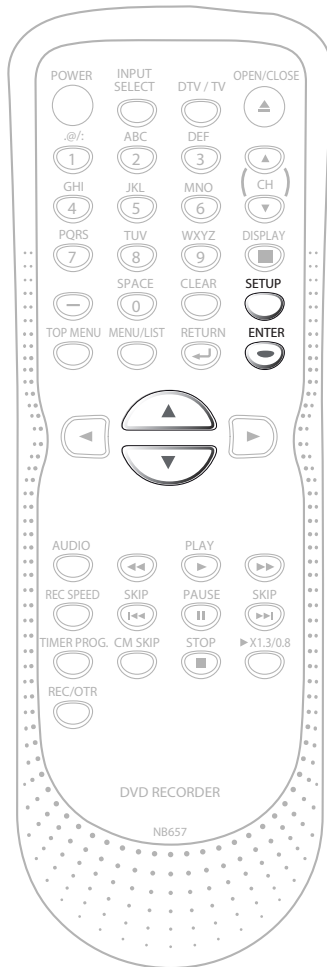

**1** Press [SETUP].

**2** Use [▲ / ▼] to select "DVD Menu", then press [ENTER].

**3** Use [▲ / ▼] to select "Disc Protect OFF → ON", then press [ENTER].  
e.g.) VR mode DVD-RW

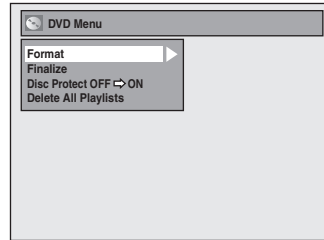

**4** Use [▲ / ▼] to select "Yes", then press [ENTER].

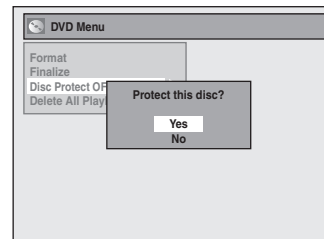

A disc will be protected.

**This operation may take awhile to be completed.**

## Note

### To cancel the disc protect:

- When you insert a disc protected with this unit, "Disc Protect ON → OFF" will appear instead of "OFF → ON".

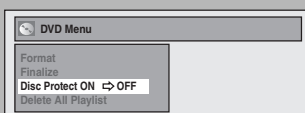

To release the protect for the disc, select "Yes" at step 4.

# PLAYING THE DISCS IN OTHER DVD PLAYERS

## Auto Finalizing



You can finalize discs automatically using this function. You can use this function to finalize discs after finishing all timer recordings and at the end of the disc space.

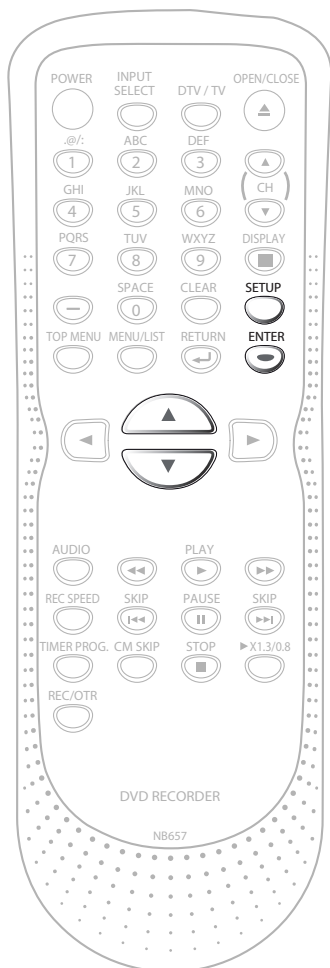

**1** Press [SETUP] and use [▲ / ▼] to select "General Setting", then press [ENTER].

"General Setting" menu will appear.

**2** Use [▲ / ▼] to select "Recording", then press [ENTER].

"Recording" menu will appear.

**3** Use [▲ / ▼] to select "Auto Finalize", then press [ENTER].

**4** Use [▲ / ▼] to select "Disc Full" or "End of Timer Rec", then press [ENTER].

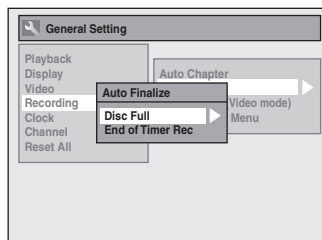

**5** Use [▲ / ▼] to select "ON", then press [ENTER].

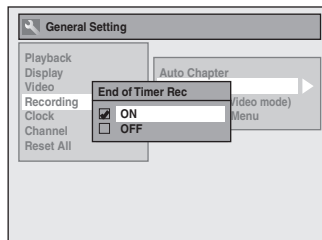
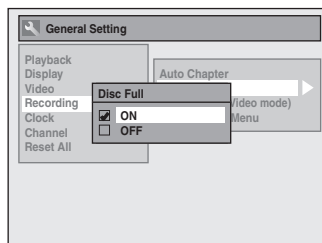

Your setting will be activated.

**6** Press [SETUP] to exit.

## Finalizing a Disc

You will need to finalize discs to play back on other DVD players.

Finalizing may take several minutes up to an hour.

Since the process of the finalization fills empty space of the disc, a shorter recording period on the disc will require a longer time period for finalization. Do not unplug the power cord during finalization.

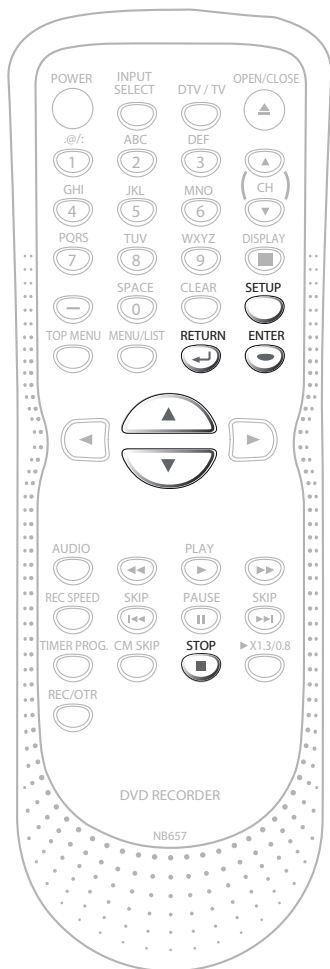

**1** Press [SETUP].

**2** Use [▲ / ▼] to select “DVD Menu”, then press [ENTER].  
“DVD Menu” will appear.

**3** Use [▲ / ▼] to select “Finalize”, then press [ENTER].

**4** Use [▲ / ▼] to select “Yes”, then press [ENTER].  
e.g.) VR mode DVD-RW

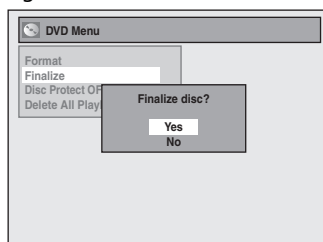

Finalizing will start.

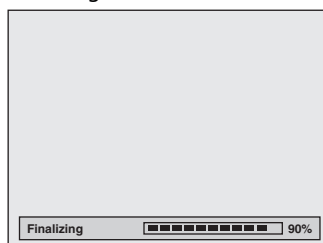

**This operation may take awhile to be completed.**

**5** Finalizing is completed.

# PLAYING THE DISCS IN OTHER DVD PLAYERS

## Note

- Finalizing a disc in video mode automatically creates a DVD menu.
- Even after DVD-RW in VR mode is finalized, you can still record or edit. After you finalize DVD-RW in video mode or DVD-R, you cannot edit or record anything else on that disc.
- If you insert a DVD-RW finalized with this unit, "Undo Finalize" will appear instead of "Finalize" at step 3.
- To release the finalization of the DVD-RW disc, select "Undo Finalize" at step 3.

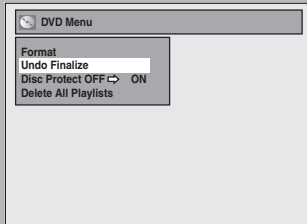

- DO NOT power off during finalizing. This may result in a malfunction.

## To cancel finalizing... (DVD-RW only)

Press **[STOP ■]** during the finalizing is in progress. Use **[▲ / ▼]** to select "Yes", then press **[ENTER]**. Finalizing is canceled and the unit switches to stop mode.

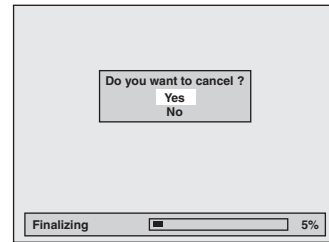

If "⊘" appears when **[STOP ■]** is pressed, you cannot cancel finalizing because the finalizing has already reached at a critical point in its process.

If "No" is selected and **[ENTER]** or **[RETURN ←]** is pressed, finalizing is continued.

You cannot cancel finalizing DVD-R once it has started.

# INFORMATION ON DVD RECORDING

## Recording Speed

You can select a recording speed among 5 options, and the recording time will depend on the recording speed you select as follows.

Recording speed	Recording time		Video/ sound quality
	12cm	8cm	
XP / 1H	60 min	18 min	☆☆☆☆☆
SP / 2H	120 min	36 min	☆☆☆☆
LP / 4H	240 min	72 min	☆☆☆
EP / 6H	360 min	108 min	☆☆
SLP / 8H	480 min	144 min	☆

- The recording times listed above are estimates and are for reference purposes only. Actual recording times may vary.
- The audio and video quality of content being recorded may differ depending on the recording speed/recording time chosen.

### Note

- **This unit cannot record to CD-RW or CD-R.**
- All high definition pictures will be down converted to the standard definition pictures when they are recorded on this unit.
- DVD-RW/-R and CD-RW/-R recorded on a personal computer or a DVD or CD recorder may not be played back if the disc is damaged or dirty or if there is condensation on the player's lens.
- If you record a disc using a personal computer, even if it is recorded in a compatible format it may not be played back because of the settings of the application software used to create the disc. (Check with the software publisher for more detailed information.)
- Discs recorded in video mode on this unit cannot record additional information using other DVD recorders.
- It is not possible to use a DVD-RW formatted with this unit on other DVD recorder unless the content of the disc was also recorded with this unit.
- Since the recording is made by the VBR (variable bit rate) method, depending on the picture you are recording, the actual remaining time for recording may be a little shorter than the remaining time displayed on the TV screen.
- **"Make Recording Compatible" in "Recording" menu does not work on this unit.**

## Restrictions on Recording

You cannot record copy-protected video using this unit. Copy-protected video includes DVD-videos and some satellite broadcasts, some pay-per-view stations and some "premium" stations. If copy-protected material is detected, recording will pause or stop automatically and an error message appears on the screen. "Copy-once only" video can only be recorded to CPRM compatible DVD-RW formatted in VR mode.

### What is "CPRM"?

CPRM is a copy protection system with scramble system regarding the recording of "copy-once" broadcast programs. CPRM stands for Content Protection for Recordable Media.

This unit is CPRM compatible, which means that you can record copy-once broadcast programs, but you cannot make another copy of those recordings. CPRM recordings can only be made on CPRM compatible DVD-RW formatted in VR mode, and CPRM recordings can only be played back on DVD players that are specifically compatible with CPRM.

### Making discs playable in other DVD players(Finalize)

For DVD-RW/-R, it is necessary to finalize the disc after recording, in order to play back the disc on other DVD players. (Refer to pages 38-40.)

When video mode DVD-RW or DVD-R are finalized, a DVD menu is created. You cannot finalize discs in other DVD recorders.

Introduction

Connections

Basic Setup

Disc Management

Recording

Playback

Editing

Function Setup

Others

Español

# BASIC RECORDING & ONE-TOUCH TIMER RECORDING

Follow the steps to record TV programs.

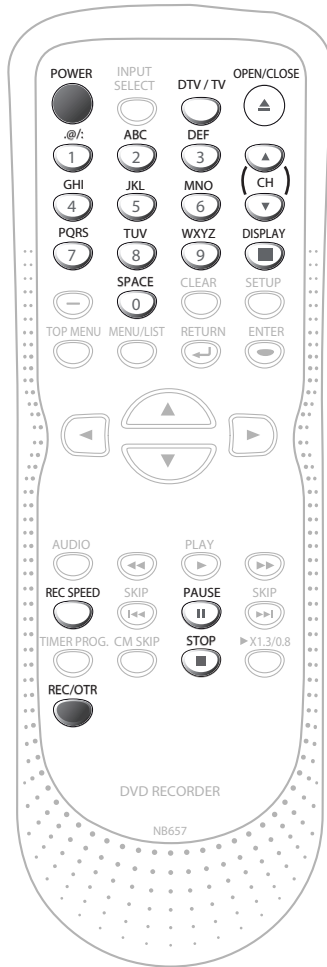

**1 Press [POWER].**  
Turn on the TV and be sure to select the input to which the unit is connected.

**2 Press [OPEN/CLOSE ▲] to open the disc tray and insert your disc with its label facing up.**

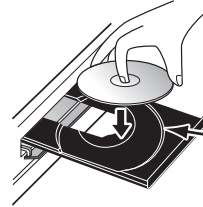

Align the disc to the disc tray guide.

**3 Press [OPEN/CLOSE ▲] to close the disc tray.**

**It may take awhile to load the disc completely.**

- When inserting a brand-new DVD-RW, the unit automatically starts to format.
- If titles have been recorded on the disc, the title list is displayed. Press [STOP ■] to exit the title list.

**4 Press [REC SPEED] to select a recording speed.**

Refer to "Recording Speed" on page 41.

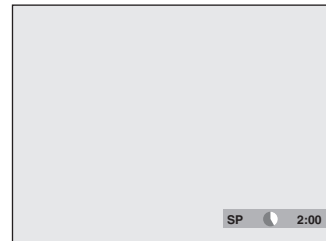

**5 Press [DTV/TV] to select analog TV or digital TV, then use [CH ▲ / ▼] or [the Number buttons] to select a desired channel to record.**

Refer to "Switching Analog Mode / Digital Mode" and "Channel Selection" on page 28.

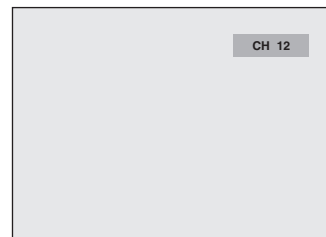

## 6 Press [REC/OTR] to start recording.

"●" will be displayed for 5 seconds.

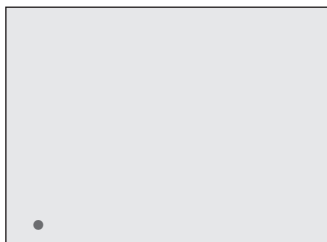

Press [PAUSE II] to pause recording.  
Press [PAUSE II] or [REC/OTR] again to restart recording.

## 7 Press [STOP ■] to stop recording.

The recorded title will be included in the title list.  
(Refer to "Guide to a Title List" on page 64.)

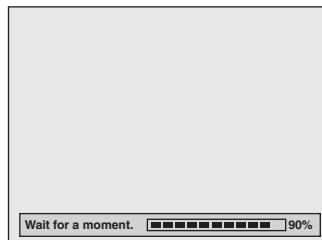

**This operation may take awhile to be completed.**

### To set one-touch timer recording (OTR)...

This is a simple way to set the recording time in blocks of 30 minutes.

Press [REC/OTR] repeatedly until the desired recording time (30 minutes to 8 hours) appears on the TV screen. One-touch timer recording will start.

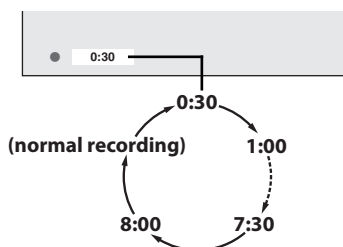

- To change the recording length during one-touch timer recording, press [REC/OTR] repeatedly until the desired length appears.
- To cancel one-touch timer recording within the specified time, press [STOP ■].

### Note

- When you press [REC/OTR], recording starts immediately and continues until the disc is full or you stop recording.
- When the unit clock has not been set, the space for a date and time of title names will be blank.
- When you record a TV program onto video mode DVD-RW or DVD-R, you have to select the TV channel audio beforehand. Only the selected channel audio will be recorded. Refer to "Selecting TV Audio" on pages 29-30 for more details.
- You cannot change the recording speed during the recording pause mode.
- You can change a channel to be recorded during the recording pause mode.

### Note for one-touch timer recording

- The remaining recording time will be displayed on the front panel display during one-touch timer recording. Press [DISPLAY] to see it on the TV screen.
- Unlike the timer recording, you can perform the following operations during one-touch timer recording.
  - Turning off the power (One-touch timer recording will be canceled.).
  - Using [REC/OTR] or [STOP ■] on the remote control.
- You cannot use the pause function during one-touch timer recording.
- When one-touch timer recording is finished and the power is turned off, the unit will switch to the timer-standby mode automatically if a timer recording has been programmed. Press [POWER] to cancel the timer-standby mode to use the unit continuously.

# TIMER RECORDING

You can program the unit to record up to 12 programs within a month in advance. Daily or weekly program recordings are also available.

## Before recording, make sure

- Set the clock before setting a timer programming.
- Insert a recordable disc with enough recordable space.

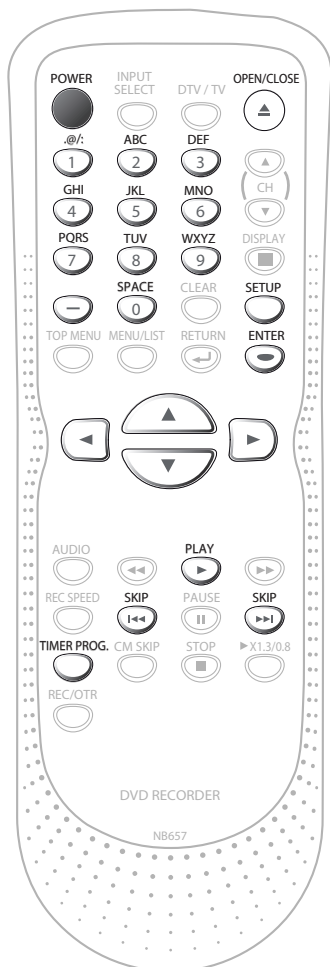

## Guide to Timer Programming Display

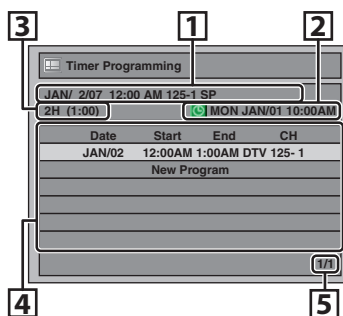

1. Title of a timer program (Contains date, time, channel, recording speed of the program)
2. Current date and time
3. Recording speed and length of the recording
4. Timer program list
5. Total number of pages and current page (2 pages maximum)

## 1 Press [TIMER PROG.].

## 2 Use [▲ / ▼] to select "New Program", then press [ENTER].

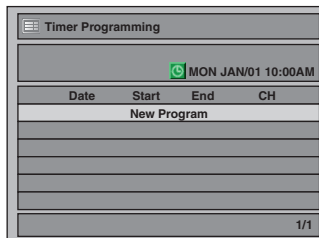

- If there are 6 or more programs, use [SKIP ◀◀ / ▶▶] to change pages.

## 3 Use [▲ / ▼] to enter the date, then press [▶].

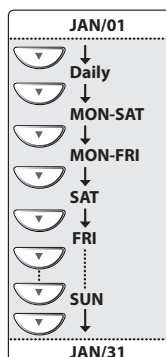
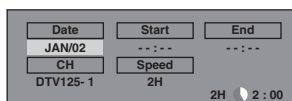

When pressing [▼] at the current date, the date will change as follows.

e.g.) January 1st

### Note

- **If you have not set the clock yet:** "Clock Setting" menu will appear instead of the timer programming list at step 1. Continue with the step 3 in "Manual Clock Setting" on page 27 before setting a timer programming.
- Use [◀ / ▶] to move the cursor to the left and the right in "Timer Programming" menu.
- Timer recording will not work when the power is on.
- When power is on, programs registered for recording in timer recording will be automatically cleared after the end time and date have passed.

## 4 Use [▲ / ▼ / ◀ / ▶] or [the Number buttons] to enter the start and end time, then press [▶].



## 5 Use [▲ / ▼ / ◀ / ▶] to select analog ("---") / digital ("DTV") mode or external input (L1 / L2), then press [▶].

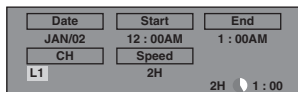

To record from external input (e.g., cable/satellite box), select L1 or L2.

Use [▲ / ▼] to select the channel number to record.

For digital mode, select both major and minor channels. Refer to "How to select a channel number for the timer recording" on this page for more details.

e.g.) analog mode

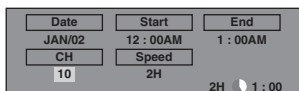

e.g.) digital mode

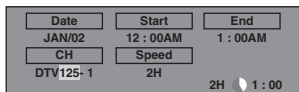

## 6 Use [▲ / ▼] to select a recording speed.

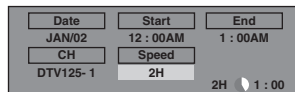

Refer to "Recording Speed" on page 41.

- You can check the remaining recordable space of the disc when you select the recording speed.



## 7 Press [ENTER] when all items are entered.

Your program setting will be stored.

- To set another program, repeat steps 2 to 7.
- To exit, press [TIMER PROG.] or [SETUP].
- When 2 or more programs are overlapped, "Timer program overlapped" appears, and the overlapped program will be displayed in blue. To correct the timer program refer to "Checking, canceling, or correcting the timer programming information" on page 46.

## 8 Press [POWER] to set a timer programming.

⏸ will appear on the front panel display, while this unit waits to make the recording.



How to select a channel number for the timer recording	
Analog TV	For channel number 2-6, press [▶] or [-] to decide the channels. For other channels (7-69), the channel will be decided as soon as you enter the channel number.
Analog CATV	For channel number 1-12, press [▶] or [-] to decide the channels. For other channels (13-125), the channel will be decided as soon as you enter the channel number.
Digital TV	For channel number 1-9, press [▶] or [-] to decide the channels. For other channels (10-99), the channel will be decided as soon as you enter the channel number.
Digital CATV	For channel number 1-13, press [▶] or [-] to decide the channels. For other channels (14-135), the channel will be decided as soon as you enter the channel number.
minor channels	For channel number 1-9, press [▶] or [-] to decide the channels. For other channels (10-99), the channel will be decided as soon as you enter the channel number.
<b>&lt;Hint&gt;</b>	
<ul style="list-style-type: none"> <li>You can decide the 1-digit channel number by pressing 0 first, then enter desired 1-digit channel number. e.g.) "5": [0]+[5]</li> <li>For selecting the channels with [▲ / ▼], you need to press [▶] or [-] to decide the channel number.</li> <li>For selecting the minor channels with [▲ / ▼], please make sure the minor channel your are selecting is existed. [▲ / ▼] does not skip the non-existed minor channels.</li> </ul>	

# TIMER RECORDING

## Checking, canceling, or correcting the timer programming information

1) Press [POWER].

 will disappear on the front panel display.

2) Press [TIMER PROG.].

3) Check the information on the list you want to edit.

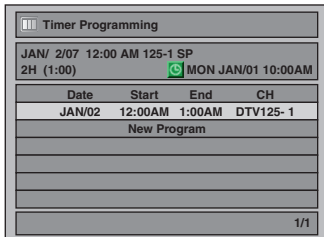

4-A) To delete the timer program:

1 Use [ $\blacktriangle$  /  $\blacktriangledown$ ] to select the program you want to delete, then press [ENTER].

2 Use [ $\blacktriangle$  /  $\blacktriangledown$ ] to select "Delete", then press [ENTER].

Selection menu will appear.

3 Use [ $\blacktriangle$  /  $\blacktriangledown$ ] to select "Yes", then press [ENTER].

4-B) To correct the timer program:

1 Use [ $\blacktriangle$  /  $\blacktriangledown$ ] to select the program you want to correct, then press [ENTER].

2 Use [ $\blacktriangle$  /  $\blacktriangledown$ ] to select "Program Change", then press [ENTER].

3 Correct the timer program by using [ $\blacktriangle$  /  $\blacktriangledown$  /  $\blacktriangleleft$  /  $\blacktriangleright$ ], then press [ENTER].

5) Press [TIMER PROG.] to exit.

6) Press [POWER] to return to the timer standby mode.

## To stop the timer recording in process

Press [STOP 

[STOP 

### Note

- Press [TIMER PROG.] to check the timer recording in progress.

When the timer recording is proceeding, that program will be highlighted with red. In this case, you cannot select any other program.

If the timer program did not complete correctly, the error number appears in the timer programming list.

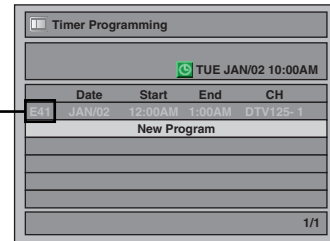





## Each error number means:

E1-22 E37-39	Recording error other than below	E35	PCA full *1
E23-24	Unrecordable disc	E36	Already finalized video format disc
E25-28	Copy prohibited program	E40	Some portion has not been recorded because of program overlapping. Recording did not start at the start time.
E29	Disc protected		
E30	Disc full		
E31-32	Already 99 titles recorded	E41	Power failed
E33	Already 999 chapters recorded	E42	No disc when recording
E34	No space for Control information		

- A program with the error number is grayed in the timer programming list.
- Once the timer programming list with error line(s) is displayed, or after canceling and setting again the timer standby mode, the program line(s) with error will be cleared.

\*1 PCA is a disc's space reserved for recording test.

## Hints for Timer Recording

- If there is a power failure or this unit has been unplugged for more than 30 seconds, the clock setting and all timer programming will be lost.
- If a disc is not inserted,  flashes and timer recording cannot be performed. In some cases,  will appear momentarily around the start point as the unit attempts to record. Please insert a recordable disc.
- When all the timer recording is completed,  flashes. To play back or eject the recorded disc, press **[POWER]** first, then select the recorded title and press **[PLAY ►]**, or **[OPEN/CLOSE ▲]** to remove the disc.
- During timer recording or timer standby mode ( will appear), any operations on the unit will not be available. To make these operations available, press **[STOP ■]** on the front panel to cancel the timer recording or **[POWER]** to release timer standby mode ( will disappear).
- To cancel the timer standby mode, press **[POWER]**.
- When the starting and the ending time are the same, the length of the recording will be set for 24 hours. When the disc becomes full during the recording, the unit turns itself off.
- When the programmed starting and ending time are earlier than the current time, the setting will not be accepted and be cleared for redoing.
- If the starting time is earlier and the ending time is later than the current time, the recording will start right after you turn the power off.
- The timer recording for digital TV cannot record any audio language other than English.

## The Priority of Overlapped Settings

- Timer program which has the earlier start time will be placed first in the timer program list, and be given priority over the programs with the later start time when timer programs overlap.
- When timer programs overlap, the first 2 minutes (at the longest) of the later recording will be cut off.
- When 2 or more timer programs have the same start time, the program set first will be given priority.
- A timer recording of lower priority will be canceled or start from the middle.
- Check the overlapped timer programmings and change the priority if necessary.

- **When the starting time is the same:**  
A program set previously (PROG. A) has priority.

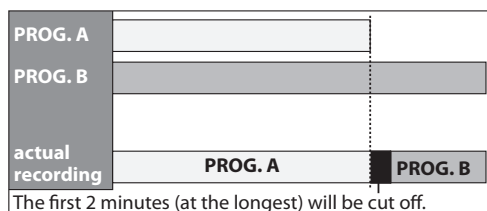

## Note for DVD recording

- When the recording time of 2 programs are overlapped, or the end time of a program and the start time of another program is the same, the first 2 minutes (at the longest) of the subsequent program will be cut off.
- If the cut-off portion comes up to 3 minute or more, this program will be displayed with error number E40 in the timer programming list.

- **When the end time of the programming currently being recorded and the start time of the subsequent program are same:**  
The beginning of the PROG. B may be cut off.

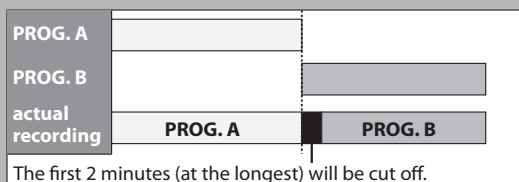

# SETTINGS FOR AN EXTERNAL DEVICE

## Connection to an External Device

Connect the external device properly to the unit by using input jacks either L2 (Front) or L1 (Rear).  
When connecting an external device of monaural output to this unit, use AUDIO L jack of L2 (Front).  
Use S-video or the RCA audio/video cables for this connection.

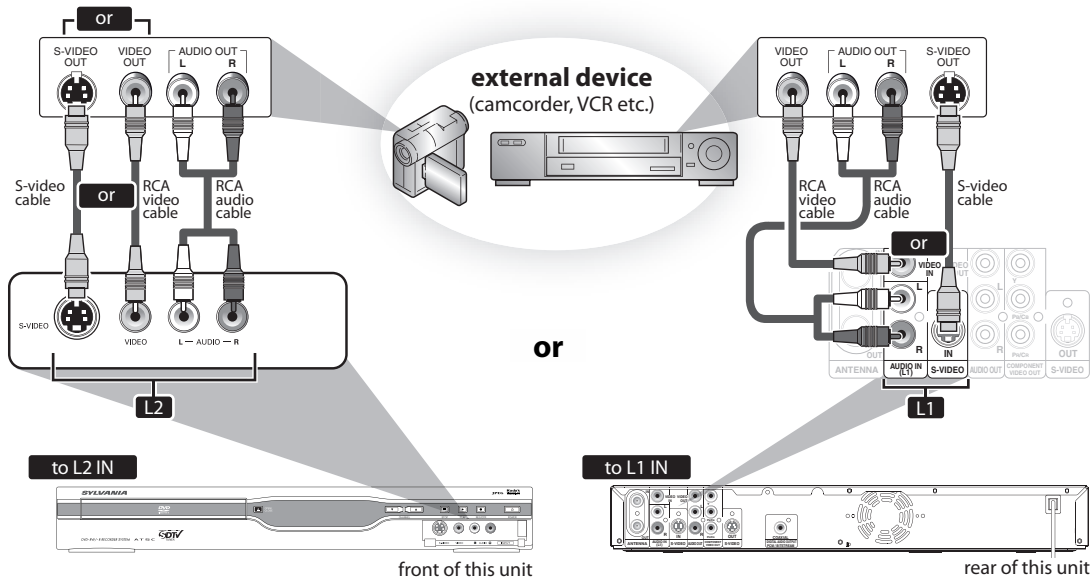

### Supplied cables used in this connection are as follows:

- RCA audio cable (L/R) x 1
  - RCA video cable x 1
- Please purchase the rest of the necessary cables at your local store.

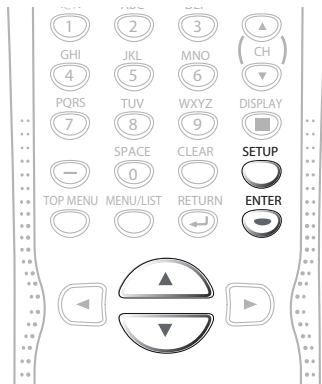

**1** Press [SETUP].

**2** Use [▲ / ▼] to select "General Setting", then press [ENTER].

**3** Use [▲ / ▼] to select "Video", then press [ENTER].

**4** Use [▲ / ▼] to select "Select Video", then press [ENTER].

**5** Use [▲ / ▼] to select desired external input position, then press [ENTER].

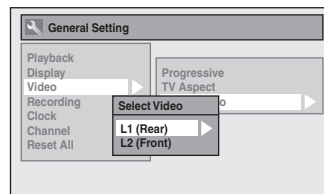

**6** Use [▲ / ▼] to select the input jack type to connect, then press [ENTER].  
If you want to use VIDEO IN jack, select "Video In".

If you want to use S-VIDEO IN jack, select "S-Video In".

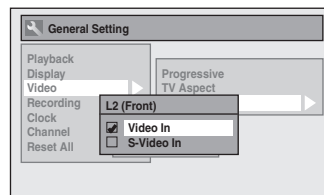

**7** Press [SETUP] to exit.

## Recording from an External Device

Before recording from an external device, refer to the instructions for the connection on page 48.

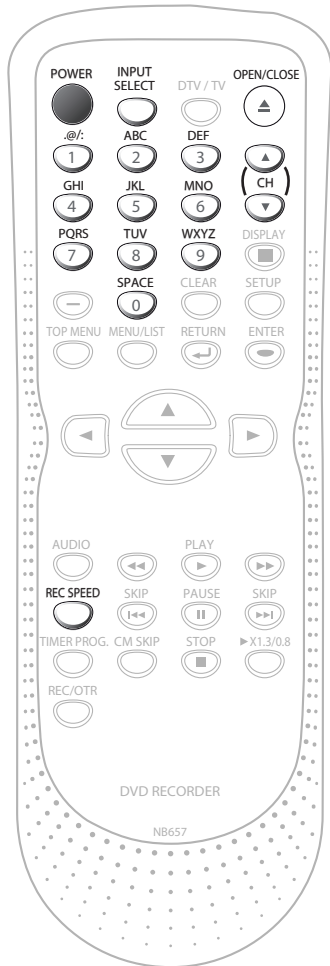

**1** Turn on the TV and press [POWER], and be sure to select the input of the TV to which the unit is connected.

**2** Press [OPEN/CLOSE ▲] to open the disc tray. Place the disc to record on properly.

**3** Press [OPEN/CLOSE ▲] to close the disc tray.

It takes awhile to load the disc.

**4** Select the input of the unit which the external device is connected. (L1 or L2)

- To use the input jacks on the rear of this unit; Select "L1" by using [INPUT SELECT] or [CH ▲ / ▼].
- To use the input jacks on the front of this unit; Select "L2" by using [INPUT SELECT] or [CH ▲ / ▼].
- You can also select "L1" or "L2" by using [the Number buttons].
  - For L1, press [0], [0], [1].
  - For L2, press [0], [0], [2].

**5** Press [REC SPEED] to select a recording speed.  
Refer to "Recording Speed" on page 41.

**6** Press [REC/OTR] on the unit to start recording.

**7** Start playback on the external device to record from.

**8** Press [STOP ■] on the unit to stop recording.

This operation may take awhile to be completed.

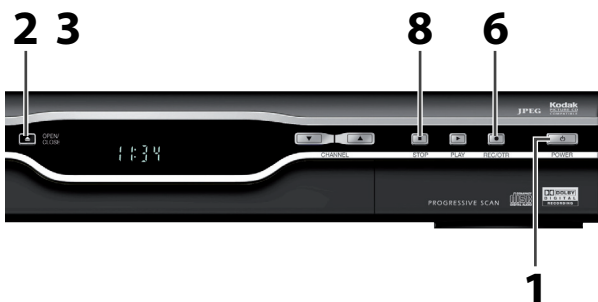

# INFORMATION ON PLAYBACK

## Structure of Disc Contents

The contents of DVD are generally divided into titles, and the titles are subdivided into chapters.

Audio CDs are divided into tracks.

Data disc contains MP3/JPEG are divided into folders, and the folders are subdivided into files.

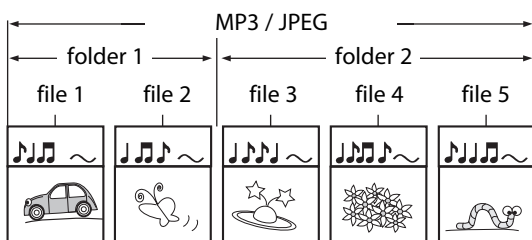
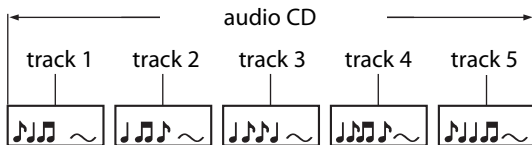
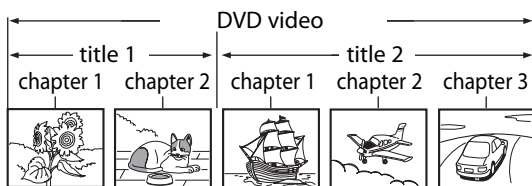

**Title:** Divided contents of a DVD video disc. Roughly corresponds to a story title in short stories.

**Chapter:** Divided contents of a title. This corresponds to a chapter in a story.

**Track:** Divided contents of an audio CD.

**Folder:** Divided contents of a MP3/JPEG data disc. Consists of number of files.

Each title, chapter, or track, folder or file is assigned a number, which is called "title number", "chapter number", "track number", "folder number" or "file number" respectively.

Some discs may not have these numbers.

# BASIC PLAYBACK

## Direct Playback

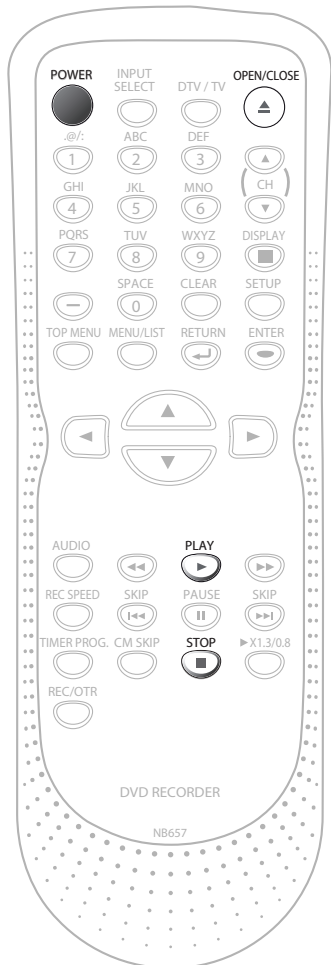

**1 Press [POWER].**  
Turn on the TV and be sure to select the input to which the unit is connected.

**2 Press [OPEN/CLOSE ▲] to open the disc tray and insert your disc with its label facing up.**

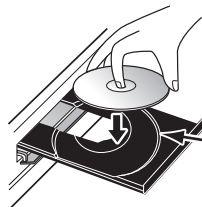

Align the disc to the disc tray guide.

**3 Press [OPEN/CLOSE ▲] to close the disc tray.**

It may take awhile to load the disc completely.

**4 Press [PLAY ►] to start playback.**  
If you are playing back a DVD-video, a menu may appear.  
Refer to "Using the Title/Disc Menu" on page 54.

**5 Press [STOP ■] once to stop playback temporarily.**  
• Refer to "Resume Playback" on page 55.

### Note

- Some discs may start playback automatically.

# BASIC PLAYBACK

## Playback from the Title List

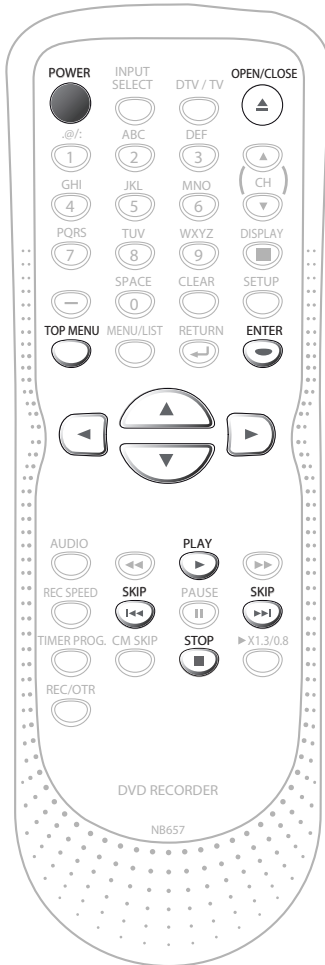

**1 Press [POWER].**  
Turn on the TV and be sure to select the input to which the unit is connected.

**2 Press [OPEN/CLOSE ▲] to open the disc tray and insert your disc with its label facing up.**

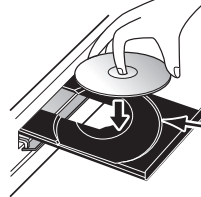

Align the disc to the disc tray guide.

**3 Press [OPEN/CLOSE ▲] to close the disc tray.**

**It may take awhile to load the disc completely.**

Title list will appear automatically.

- To exit the title list, press [STOP ■].
- To resume the title list, press [TOP MENU].

**4 Use [▲ / ▼ / ◀ / ▶] to select a desired title, then press [ENTER].**  
e.g.) VR mode DVD-RW original

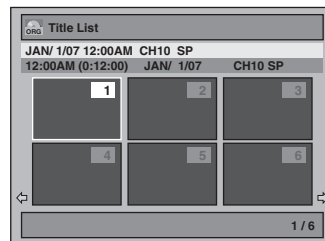

**5 Use [▲ / ▼] to select "Play From Start", then press [ENTER].**

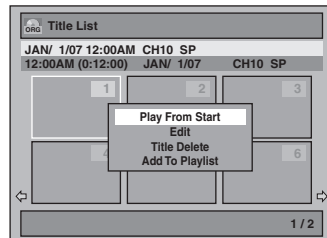

Playback will start.

**6 Press [STOP ■] once to stop playback temporarily.**

- Refer to "Resume Playback" on page 55.

To eject the disc, press [OPEN/CLOSE ▲] to open the disc tray, then remove the disc before turning off the unit.

### Note

- Some discs may start playback automatically.
- You can also start playback by pressing [PLAY ▶] instead of [ENTER] at step 5.
- At step 4, you can press [SKIP ▶▶], or press [▶] when the title on the lower right of the title list is highlighted to display the next page, and press [SKIP ◀◀], or press [◀] when the title on the upper left of the title list is highlighted to display the previous page.

## Playing Back an Audio CD and a CD-RW/-R with MP3 / JPEG Files

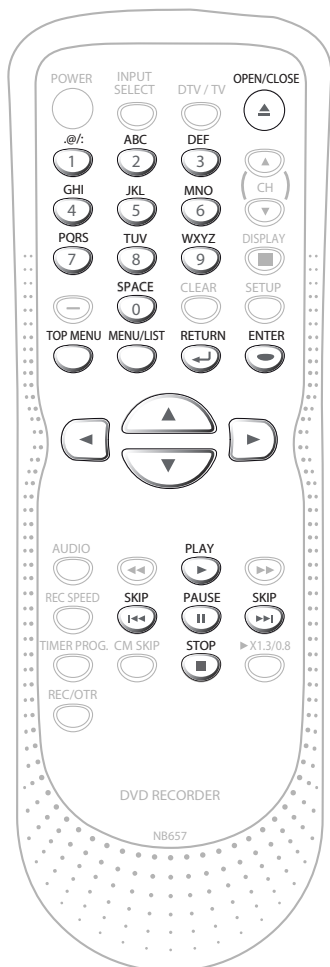

**1** Follow steps 1 to 2 in “Direct Playback” on page 51.

**2** Press [OPEN/CLOSE ▲] to close the disc tray.

It may take awhile to load the disc completely.

File list will appear automatically.

- To exit the file list, press [STOP ■].
- To resume the file list, press [TOP MENU].

**3** Use [▲ / ▼] to select a desired folder or track/file, then press [ENTER].

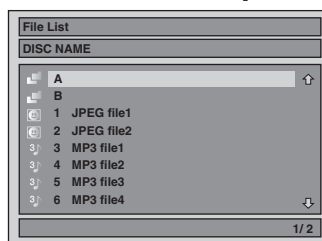

**When selecting track/file:**

Playback will start.

**When selecting folder:**

The files in the folder will appear.

Use [▲ / ▼] to select the file or folder you want to play back, then press [ENTER].

- Press [PLAY ▶], [ENTER] or [▶] to move to any lower hierarchies.
- Press [◀] or [RETURN ◀] to move back to the previous hierarchy.

**Hints for audio CD tracks and MP3 / JPEG files:**

- Folders are shown by [folder icon].
- Audio CD tracks are shown by [CD icon].
- MP3 files are shown by [MP3 icon].
- JPEG files are shown by [JPEG icon].
- The system can recognize up to 255 folders and, up to 99 tracks/999 files.
- Letters of a file/folder name overflowing the given space will be displayed as “...”.
- If there are no files in the folder, “No Files” will be displayed.

**It is recommended that files to be played back in this unit are recorded under the following specifications:**

<MP3>

- Sampling frequency : 44.1 kHz or 48 kHz.
- Constant bit rate : 112 kbps - 320 kbps

<JPEG>

- Upper limit : 6,300 x 5,100 dots.
- Lower limit : 32 x 32 dots.
- File size of image maximum : 12 MB.

### Note

- The audio source of MP3 files cannot be recorded as digital sound by an MD or DAT deck.
- Files whose extension is other than “.mp3(MP3)” or “.jpg / .jpeg(JPEG)” will not be listed.
- Some unplayable folders or files may be listed due to the recording status.
- High-resolution JPEG files take longer to be displayed.
- Progressive JPEG files (JPEG files saved in progressive format) cannot be played back on this unit.
- The JPEG pictures can also rotate by using [▲ / ▼ / ◀ / ▶].

# BASIC PLAYBACK

## Playing Back an Audio CD and a CD-RW/-R with MP3 JPEG Files (cont'd)

### Kodak Picture CD

The Picture CD is a service to convert photographs taken by a conventional film camera into digital data and write the data on a CD. You can enjoy picture images on the TV set by playing back the Picture CDs.

For details of Kodak Picture CD, contact a shop that provides developing service of Kodak Inc.

1) Press [TOP MENU].



• To exit the Picture CD thumbnail List, press [TOP MENU] again or press [STOP ■].

Arrow icons mean the title list includes a next or previous page. Use [◀ / ▶] in the direction of the icon you wish to follow. You can also quick review the six thumbnails at once between the first and last pages by pressing [SKIP |◀◀ / ▶▶|].

2) Use [▲ / ▼ / ◀ / ▶] to select a desired track to be played back, then press [PLAY ▶] or [ENTER].

An image will be played back from the selected track and go to the next one in turn.

3) Press [STOP ■] to stop playback.

#### Notes on JPEG and Kodak Picture CD:

• After track is displayed for 5 seconds or 10 seconds (set in the "Slide Show" on page 61) the display moves to the next track.

During JPEG or Kodak Picture CD playback, press [▶] or [◀] to rotate a picture 90 degrees clockwise or counterclockwise respectively.

(Not available when the display menu appears.)

## Using the Title / Disc Menu



DVD may contain a title list, which describes the contents of the disc, or a disc menu, which guides you through the available functions in the disc.

1) Press [MENU/LIST] or [TOP MENU] to call up the title list or disc menu.

2) Use [▲ / ▼ / ◀ / ▶] to make a selection, and then press [ENTER] to enable your selection.

3) Press [STOP ■] to exit the disc menu.

#### Note

- You can select a numbered menu with [the Number buttons] also.
- Menus vary among discs. Refer to the information accompanying the disc for details.
- [MENU/LIST] or [TOP MENU] will not always be effective for all DVDs.

## Pause

1) During playback, press [PAUSE II].

Playback will be paused and sound will be muted.

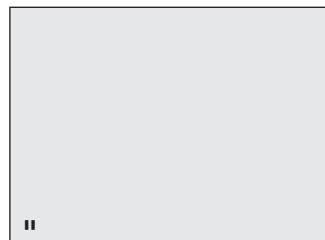

2) Press [PLAY ▶] to return to the normal playback.

#### Note

- For DVD, set "Still Mode" to "Field" in "Playback" menu if pictures in the pause mode are blurred. (Refer to page 83.)

# SPECIAL PLAYBACK

## Resume Playback

You can play back from where you stopped playing back the disc last.

### 1) During playback, press [STOP ■].

The resume message will appear.

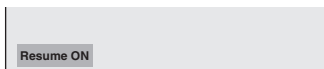

### 2) Press [PLAY ►].

In a few seconds, playback will resume from the point at which it stopped last. You can resume playback at the same point even if you turn off the unit.

To cancel the resume playback and start playing back the disc from the beginning, press [STOP ■] again while the playback is stopped.

### Note

- For MP3/JPEG files, playback will resume from the beginning of the file at which playback was stopped.

## Fast Forward / Fast Reverse Playback



### 1) During playback, press [FWD ►►] or [REV ◀◀].

Every time you press [FWD ►►] or [REV ◀◀], approximate speed will be changed as follows.

Fast forward or fast reverse playback across titles (for DVD), or files (for MP3 files) is not possible.



For audio CD, MP3 files, approximate speed is fixed at 8x with sound.

### 2) Press [PLAY ►] to return to the normal playback.

### Note

- Forward/reverse speed will be indicated with icons as follows.

forward (approx. speed)

2x: ►►

20x: ►►►

40x: ►►►►

reverse (approx. speed)

5x: ◀◀

20x: ◀◀◀

40x: ◀◀◀◀

## Skipping TV Commercials During Playback



You can skip TV commercials to enjoy the recorded programs without interrupting.

### During playback, press [CM SKIP].

Normal playback will start at 30 seconds ahead from the point you press [CM SKIP].

Every time you press [CM SKIP], the searching point will be extended by 30 seconds ahead.

You can press [CM SKIP] up to 6 times (180 seconds).

e.g.) Press [CM SKIP] once.

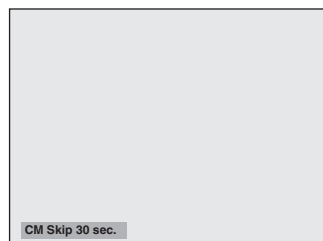

(forwarding 30 seconds)

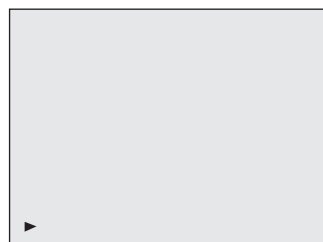

Playback will return to the normal playback.

# SPECIAL PLAYBACK

## Rapid Playback



**Rapid playback function is available only during playback.**

This function is available only on discs recorded in the Dolby Digital format, and plays back in a slightly faster/slower speed while keeping the sound quality just as normal playback.

**1) During playback, press [▶x1.3/0.8].**

- ▶ : Press [▶x1.3/0.8] once during playback. Plays back approximately at 0.8 times of normal playback.
- ▶ : Press [▶x1.3/0.8] twice during playback. Plays back approximately at 1.3 times of normal playback.
- ▶: Press [▶x1.3/0.8] thrice to play back in normal speed. No effects.

**2) Press [PLAY ▶] to resume the normal playback.**

### Note

- Audio (language) setting cannot be changed while using this mode.
- This feature may not work at some point in a disc.
- Audio is PCM during rapid playback mode except when using digital audio connection.
- When using digital audio connection (COAXIAL), the LPCM sound (2 channel) will be output.

## Step by Step Playback



**1) During playback, press [PAUSE II].**

Playback will be paused and sound will be muted.

**2) Press [SKIP ▶▶▶] repeatedly.**

Playback will advance one frame at a time when you press [SKIP ▶▶▶] with the sound muted.

To play back step by step backward:

Press [SKIP I◀◀] repeatedly.

Every time you press the button, the playback will go backward by one frame.

- Press and hold [SKIP I◀◀] / [SKIP ▶▶▶] to reverse/advance continuously.

**3) Press [PLAY ▶] to resume the normal playback.**

## Slow Forward / Slow Reverse Playback



**1) During playback, press [PAUSE II]. Then press [FWD ▶▶] or [REV ◀◀].**

Every time you press [FWD ▶▶] or [REV ◀◀], approximate speed will be changed as follows. (The sound will remain muted.)



To return to the normal playback, press [PLAY ▶].

### Note

- Forward/reverse speed will be indicated with icons as follows.

forward (approx. speed)

1/16x:

1/8x:

1/3x:

reverse (approx. speed)

1/16x:

1/8x:

1/4x:

## Zoom



1) During playback, press [DISPLAY].

2) Use [◀/▶] to select , then press [ENTER] within 1 second, or wait for 1 second to display the selection menu.

e.g.) DVD-video

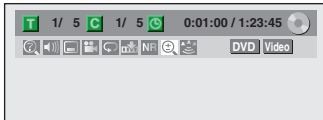

3) Use [▲ / ▼] to select a desired zoom factor to zoom, then press [ENTER].

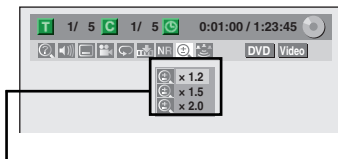

Zoom menu will appear.

There are four options (x1.0, x1.2, x1.5 and x2.0), these are displayed excluding the current zoom rate.

Zoom area will be displayed.

4) Use [▲ / ▼ / ▶ / ◀] to select a desired zoom position, then press [ENTER].

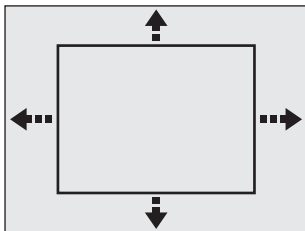

Zoom playback will start.

### Note

- When selecting a smaller factor than the current one, the zoom area will not be displayed.
- To exit the zoom menu, press [DISPLAY] repeatedly.
- To cancel the zoom function, select "x1.0" using [▲ / ▼], then press [ENTER] at step 3.
- You cannot slide the zoomed picture on some JPEG files.

## Marker Setting



This feature allows you to assign a specific point on a disc to be called back later.

1) During playback, press [DISPLAY].

2) Use [◀/▶] to select , then press [ENTER] within 1 second, or wait for 1 second to display the marker list.

e.g.) DVD-video

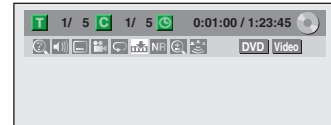

3) Use [▲ / ▼] to select a desired marker number. When it reaches the desired point, press [ENTER].

e.g.) DVD-video

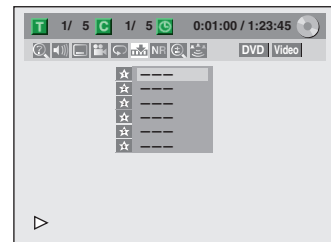

The title (track) number and the time will be displayed.

4) To return to the marker:

Use [▲ / ▼] to select the desired marker number, then press [ENTER].

### Note

- To clear a marker, select the marker number to be cleared, then press [CLEAR].
- All markers will be erased when you operate these operations listed below.
  - Opening the disc tray
  - Turning off the power
  - Record on a recordable disc
- You can mark up to 6 points.

# SEARCH

## Title/Chapter Search



### Using [SKIP |◀◀] / [SKIP ▶▶|]

- 1) During playback, press [SKIP ▶▶|] to skip the current title or chapter and move to the next.

The title or chapter will move forward by one at a time.

- If there is no chapter in one title, the current title will be skipped.

To go back to the beginning of the current title or chapter, press [SKIP |◀◀].

Press it twice in quick successions to go to the previous title or chapter. The title or chapter will move backward one title at a time.

### Using [DISPLAY]

- 1) During playback, press [DISPLAY].

- 2) Use [◀/▶] to select , then press [ENTER].

e.g.) DVD-video

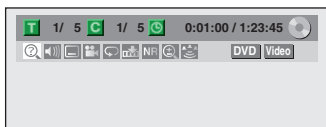

The number next to  will be highlighted.

- 3) Title:

Use [▲ / ▼] or [the Number buttons] to enter a desired title number to search, then press [ENTER].

Title search will start.

#### Chapter:

Press [▶] to move to the number next to  for chapter.

Use [▲ / ▼] or [the Number buttons] to enter a desired chapter number to search, then press [ENTER].

After the search, playback will start automatically.

### Note

- In search mode display, total numbers of each search contents (title/chapter/time) are shown as a denominator.

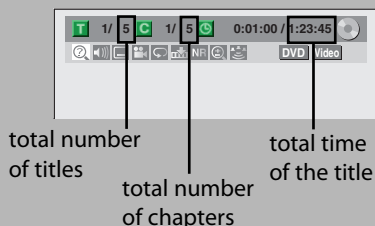

## Track Search



### Using [SKIP |◀◀] / [SKIP ▶▶|]

- 1) During playback, press [SKIP ▶▶|] to skip the current track/file and move to the next.

The track/file will move forward one at a time.

To go back to the beginning of the current track/file, press [SKIP |◀◀].

Press it twice in quick successions to go to the previous track/file. The track/file will move backward one at a time.

### Using [DISPLAY]

- 1) During playback, press [DISPLAY].

- 2) Use [◀/▶] to select , then press [ENTER].

e.g.) audio CD

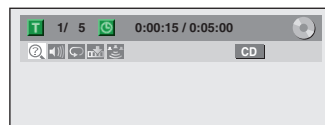

e.g.) MP3 files

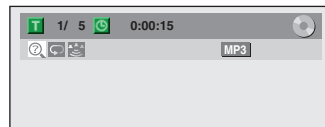

The number next to  will be highlighted.

- 3) Use [▲ / ▼] or [the Number buttons] to enter a desired track/file number to search, then press [ENTER].

After the search, playback will start automatically.

### Note

- During CD playback, you can enter a track number directly using [the Number buttons] for track search without displaying the menu.

## Time Search



1) During playback, press [DISPLAY].

2) Use [◀/▶] to select , then press [ENTER].

e.g.) DVD-video

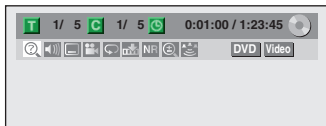

e.g.) audio CD

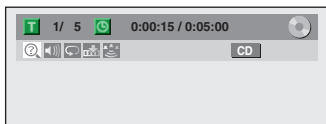

The number next to  will be highlighted.

To move to the number next to , press [▶].

When time search is not available,  and time counter are not displayed.

3) Use [▲ / ▼ / ◀ / ▶] or [the Number buttons] to enter a desired time to search, then press [ENTER].

After the search, playback will start automatically.

### Note

- Time search is available only in the same track, file or title.

# REPEAT/RANDOM/PROGRAM PLAYBACK/SLIDE SHOW

## Repeat Playback

Available repeat function may vary depending the discs.

- 1) During playback, press [DISPLAY], then proceed step 2), or press [REPEAT] then proceed to step 3).
- 2) Use [◀/▶] to select , then press [ENTER] within 1 second, or wait for 1 second to display the selection menu.

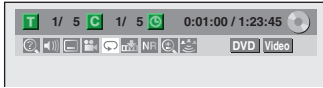

- 3) Use [▲ / ▼] to select a desired option to repeat, then press [ENTER].

e.g.) DVD-video

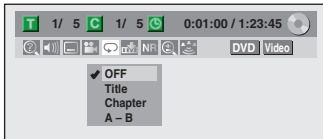

e.g.) audio CD

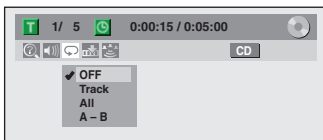

e.g.) MP3/JPEG files

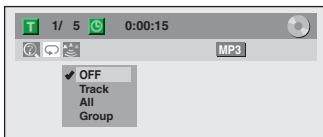

The selected repeat playback will start.

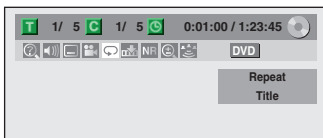

### Title:

The current title will be played back repeatedly.

### Chapter:

The current chapter will be played back repeatedly.

### All:

The current disc will be played back repeatedly.

### A-B:

Desired section can be played back repeatedly.

- 1) Use [▲ / ▼] to select "A-B", then press [ENTER].
- 2) Press [ENTER] at the desired starting point A.
- 3) Press [ENTER] at the desired ending point B.

### Track:

The current track or file will be played back repeatedly.

### Group:

The current folder will be played back repeatedly.

## Note

- Point B for the repeat A-B playback should be set within the same chapter or track of point A.
- To cancel the repeat playback, select "OFF" at step 3. The repeat setting will also be canceled when you stop playback.
- You cannot select "Group" during the random playback of MP3/JPEG files.
- Chapter/Track repeat will be canceled whenever [SKIP ▶▶] or [SKIP ◀◀] is pressed.

## Random Playback



You can play back a disc randomly instead of playing back in the original order.

- 1) Press [SETUP] in stop mode.

- 2) Use [▲ / ▼] to select "CD Playback Mode", then press [ENTER].

"CD Playback Mode" menu will appear.

- 3) Use [▲ / ▼] to select "Random Play", then press [ENTER].

Random playback will start.

e.g.) audio CD

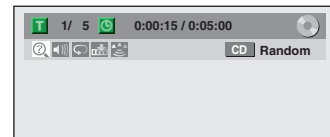

## Note

- To cancel random playback, press [STOP ■] twice during random playback. "OFF" appears on the display menu.

## Program Playback



You can program the disc to play back in your desired order.

- 1) Press [SETUP] in stop mode.
- 2) Use [▲ / ▼] to select "CD Playback Mode", then press [ENTER].  
"CD Playback Mode" menu will appear.
- 3) Use [▲ / ▼] to select "Program Play", then press [ENTER].
- 4) Use [▲ / ▼] to select a desired track, then press [ENTER] or [▶].

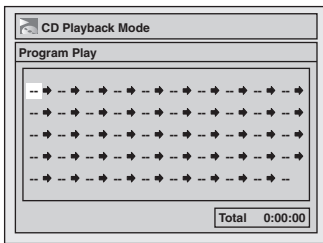

Repeat this step until you program all the desired tracks.

- 5) Press [PLAY ▶].

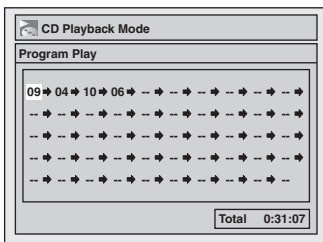

Program playback will start.

### Note

- To erase tracks you selected, press [CLEAR] at step 4.
- You can make program settings up to 50 tracks.
- To cancel program playback, press [STOP ■] twice during program playback. "OFF" appears on the TV screen.
- You may also select a desired track using [the Number buttons] at step 4.

## Slide Show



You can select the display time between 5 seconds and 10 seconds.

- 1) Follow steps 1 and 2 in "Program Playback" on the left.
- 2) Use [▲ / ▼] to select "Slide Show", then press [ENTER].
- 3) Use [▲ / ▼] to select the display time, then press [ENTER].
- 4) Press [SETUP] to exit.

### Note

- Large-size JPEG files take a few moments to be displayed.

# SELECTING THE FORMAT OF AUDIO AND VIDEO

You can select the format of audio and video as you prefer depending on the contents of the disc you are playing back.

## Switching Subtitles



DVD-video may have subtitles in one or more languages. Available subtitle languages can be found on the disc case. You can switch subtitle languages anytime during playback.

- 1) During playback, press [DISPLAY].
- 2) Use [◀/▶] to select , then press [ENTER] within 1 second, or wait for 1 second to display the selection menu.  
e.g.) DVD-video

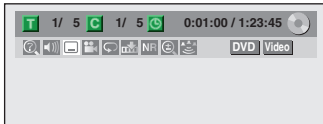

- 3) Use [▲ / ▼] to select a desired subtitle language, then press [ENTER].

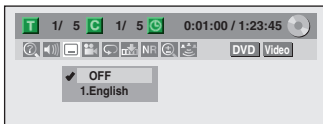

Subtitle will be displayed in the selected language. When "OFF" is selected, subtitle will disappear.

### Note

- Some discs will only allow you to change the subtitle from the disc menu. Press [MENU/LIST] or [TOP MENU] to display the disc menu.
- If a 4-digit language code appears in the subtitle menu, refer to the "LANGUAGE CODE" on page 93.

## Switching Audio Soundtrack



When playing back a DVD-video recorded with 2 or more soundtracks (these are often in different languages), you can switch them during playback.

When playing back audio CD, you can switch "L/R"(stereo), "L"(left) or "R"(right).

- 1) During playback press [DISPLAY], then proceed to step 2), or press [AUDIO] then proceed to step 3).
- 2) Use [◀/▶] to select , then press [ENTER] within 1 second, or wait for 1 second to display the selection menu.

- 3) Use [▲ / ▼] to select a desired audio soundtrack or audio channel, then press [ENTER].

For DVD-video or VR mode DVD-RW

- Audio soundtrack will switch.

e.g.) DVD-video

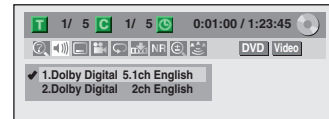

- If the title contains both main and sub audio, you can further select "L" (main), "R" (sub), "L/R" (mixed of main and sub).

For audio CD

- Audio channel will switch.

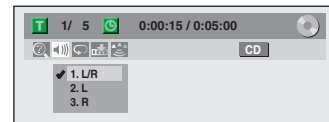

### Note

- Some discs will only allow you to change the soundtrack from the disc menu. Press [MENU/LIST] or [TOP MENU] to display the disc menu.

## Switching Virtual Surround System



You can enjoy stereophonic virtual space through your existing 2 channel stereo system.

1) During playback, press [DISPLAY].

2) Use [◀/▶] to select , then press [ENTER] within 1 second, or wait for 1 second to display the selection menu.

e.g.) DVD-video

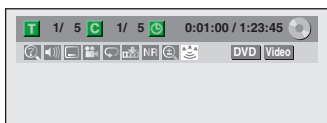

3) Use [▲/▼] to select "OFF", "Type 1" or "Type 2", then press [ENTER].

e.g.) DVD-video

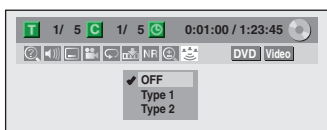

**OFF** : no effect

**Type 1** : natural effect

**Type 2** : emphasized effect

### Note

- Select "OFF" if sound is distorted.
- The setting will be kept when the unit is turned off.

## Switching Camera Angles



Some DVD-video have scenes shot from 2 or more angles. Angle information should be on the disc case if the disc contains multi-angle scenes.

1) During playback, press [DISPLAY].

2) Use [◀/▶] to select , then press [ENTER].

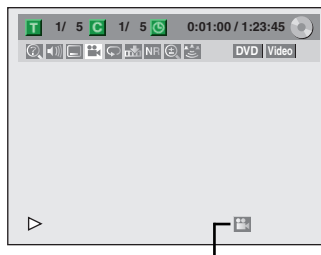

Angle icon appears when a switching camera angle is available.

Angle will switch each time you press [ENTER].

### Note

- Angle icon does not appear on the TV screen if you set "Angle Icon" to "OFF" in "Playback" menu. Refer to page 83.

## Reducing Block Noise



1) During playback, press [DISPLAY].

2) Use [◀/▶] to select , then press [ENTER] within 1 second, or wait for 1 second to display the selection menu.

e.g.) DVD-video



3) Use [▲/▼] to select a desired option, then press [ENTER].

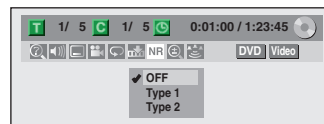

Your setting will be activated.

This function reduces noise in the playback picture. If noises appear on the TV screen during playing back discs recorded in long time recording speed such as 6H or 8H, select "Type 1" or "Type 2". ("Type 2" is more effective.)

When playing back discs with a few noises such as DVD-video, select "OFF".



# INFORMATION ON DISC EDITING

## Guide to a Title List

Title list allows you to check the titles recorded on the disc easily. You can choose a title to play back from this list and easily edit the titles as you prefer.

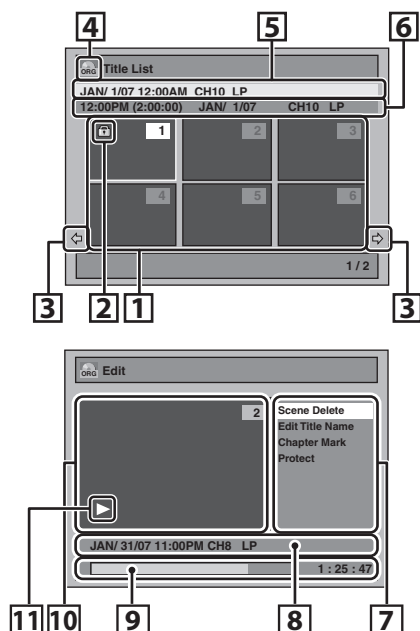
Press [TOP MENU].



- 1. Title list:** List of the titles recorded on the disc, and their information.
  - 2.** The protect icon, which appears when the title has been protected. (Original titles only)
  - 3. Arrow:** Indicating there is a previous / next page.
  - 4.** Title list icon, which indicates a type of the displayed title list.
-  : VR(original).  
 : VR (Playlist).  
 : Video mode.
- 5.** Title name.
  - 6.** Title information, which displays recorded year/ date/ month/ time, length of the title, recorded external input mode (CH, L1 or L2), and the recording speed.
  - 7. Submenu:** Submenus for the selected menu are displayed here.
  - 8. Title name (editable):** If you do not name the title, the recorded date, time, channel and the recording speed are displayed here.
  - 9. Progress bar:** Indicating the progress of the playback.
  - 10. Preview window:** Preview of the selected title is displayed here.
  - 11. Playback status:** Indicating the current playback status of the selected title.

Press [RETURN ←→] to exit the title list.

## Editing Discs

### Edit the recorded disc

You will find editing discs is easy. This unit offers convenient edit functions which are possible only with DVD-RW/-R discs.

**You can edit the following from a title list.**

- Assigning a name to a title
- Dividing a title
- Combining titles
- Adding titles to a playlist
- Erasing all playlist
- Setting or releasing the title protection
- Adding or deleting chapter marks
- Deleting titles or parts of titles

(Possible editing functions depend on the recording format and editing method.)

### Original and playlist (VR mode)

For VR mode DVD-RW, you can edit the recordings in playlist without changing the original recordings. Playlist does not take up much disc space. After you make a recording to VR mode DVD-RW, a playlist will be created automatically.

### What "Original" or "Playlist" is for?

Throughout this manual, you will find original and playlist which refer to the actual content and the edited version.

- **Original** content refers to what's actually recorded on the VR mode DVD-RW.
- **Playlist** content refers to the edited version of the VR mode DVD-RW; how the original content is to be played back.

### Finalizing a disc

- This will allow a disc that is recorded on this unit to be played back on other DVD player — without finalization it will not be playable on other DVD player.
- After finalizing DVD-RW/-R, you cannot edit any information that is on that disc.

### Note

- Once a disc is finalized, editing the disc or recording to the disc will not be available (except DVD-RW in VR mode).
- A playlist is not available with the DVD-R and DVD-RW in video mode.

# DELETING TITLES

## Notes for deleting titles

After the disc is fully recorded:

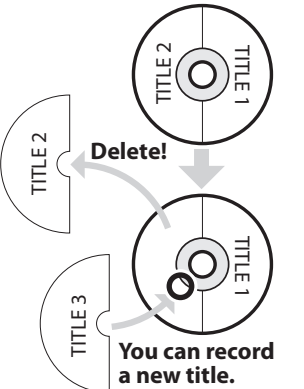
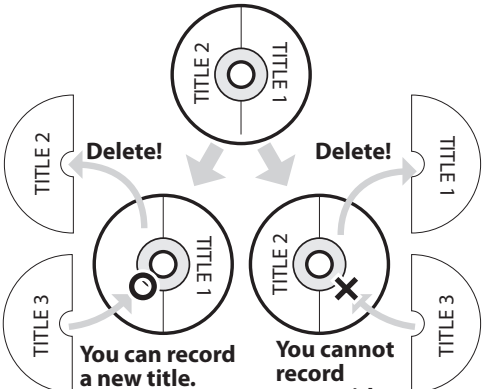
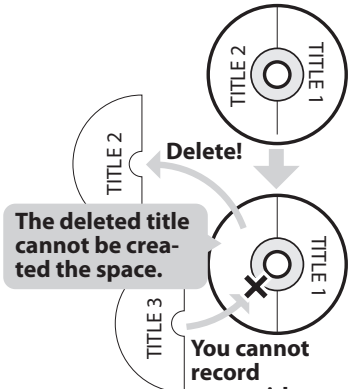
	DVD-RW	DVD-R
<ul style="list-style-type: none"><li>When a title is deleted from DVD-RW in VR mode, the recordable disc space will be increased.</li></ul> <p>The Full-Recorded disc</p>  <p>You can record a new title.</p>	<ul style="list-style-type: none"><li>When the last title is deleted from DVD-RW in video mode, the recordable space will be increased.</li></ul> <p>The Full-Recorded disc</p>  <p>You can record a new title.</p> <p>You cannot record a new title.</p>	<ul style="list-style-type: none"><li>When a title is deleted from DVD-R, the recordable space will NOT be increased.</li></ul> <p>The Full-Recorded disc</p>  <p>The deleted title cannot be created the space.</p> <p>You cannot record a new title.</p>

Once all editings are made, press **[RETURN ←]** in several times to exit the editing mode. "Writing to Disc" appears momentarily. It also appears when pressing **[OPEN/CLOSE ▲]** or **[POWER]** before exiting the editing mode after editing.

# DELETING TITLES

You can delete titles which you do not need anymore. Please be advised that the titles once deleted cannot be brought back to the disc.  
Be sure to read "Notes for deleting titles" on page 65 before you delete the title.

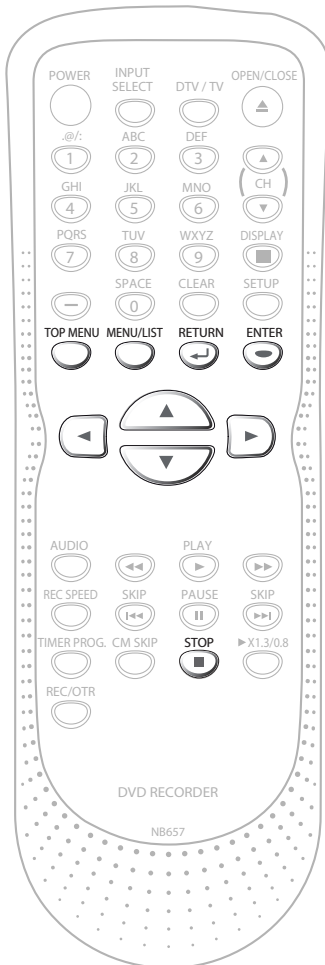

**1 In stop mode, press [TOP MENU].**  
Title list, original or playlist will appear.  
• For DVD-RW VR mode, press [MENU/LIST] to switch between "Original" and "Playlist" if the disc is recorded in VR mode.

**2 Use [▲ / ▼ / ◀ / ▶] to select a desired title, then press [ENTER].**  
e.g.) VR mode DVD-RW original



**3 Use [▲ / ▼] to select "Title Delete", then press [ENTER].**



**4 Use [▲ / ▼] to select "Yes", then press [ENTER].**

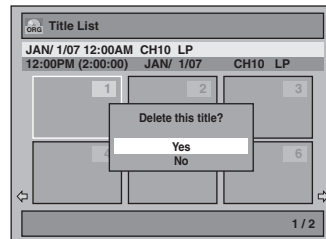

After that, "Are you sure?" will appear, select "Yes" and then press [ENTER].  
Title will be deleted.

**5 Press [RETURN ↵] or [STOP ■] to exit.**  
Data will be written onto the disc momentarily.



**This operation may take awhile to be completed.**

# CREATING/DELETING PLAYLIST

## Adding Titles to a Playlist



For VR mode DVD-RW, you can create the playlist as you wish.

You can add up to 99 titles to a playlist (as long as the total number of the playlist does not exceed 999 chapters).

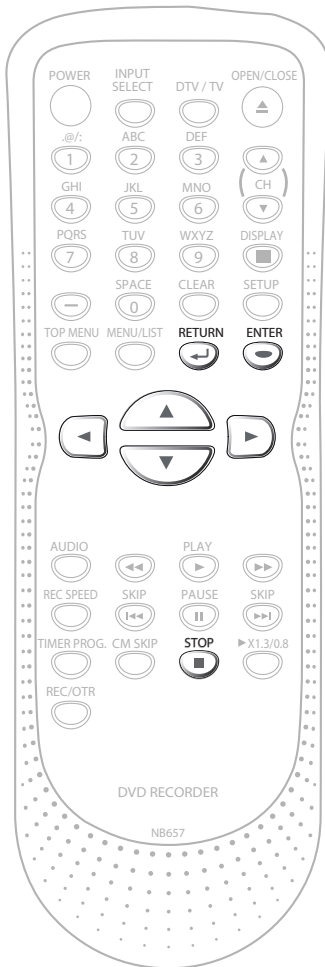

**1** Follow the step 1 in “DELETING TITLES” on page 66 to display the original.

**2** Use [▲ / ▼ / ◀ / ▶] to select the desired title, then press [ENTER].

**3** Use [▲ / ▼] to select “Add To Playlist”, then press [ENTER].

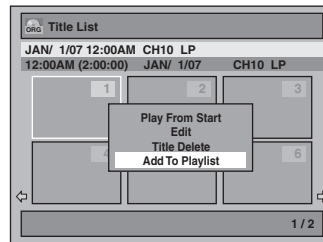

**4** Use [▲ / ▼] to select “Yes”, then press [ENTER].

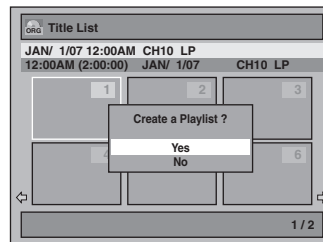

The title is added to playlist.

**5** Press [RETURN ◀] or [STOP ■] to exit. Writing on the disc starts. It may take awhile to write the data on a disc.

### Note

- To delete a title from the playlist, refer to “DELETING TITLES” on page 66.
- To delete all titles in the playlist, refer to “Erasing All Playlist” on page 68.
- When a playlist contains 99 titles or more, or 999 chapters or more, “Add to Playlist” cannot be selected.

# CREATING/DELETING PLAYLIST

## Erasing All Playlist



A playlist can be deleted if it is no longer needed.

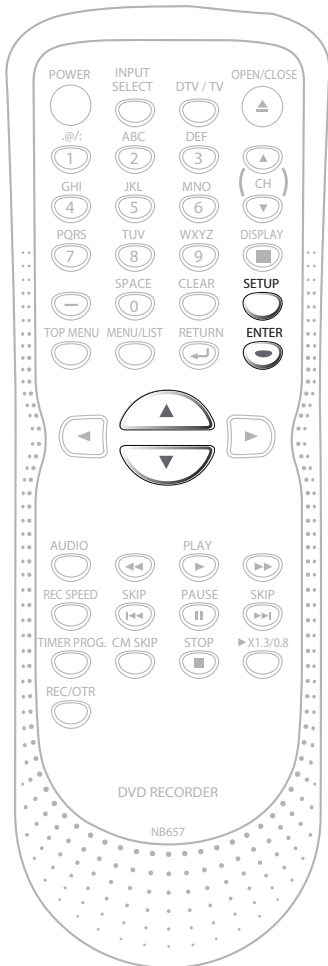

**1** Press [SETUP].  
Main menu will appear.

**2** Use [▲ / ▼] to select "DVD Menu",  
then press [ENTER].

**3** Use [▲ / ▼] to select "Delete All  
Playlists", then press [ENTER].

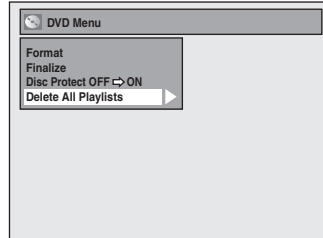

**4** Use [▲ / ▼] to select "Yes", then press  
[ENTER].

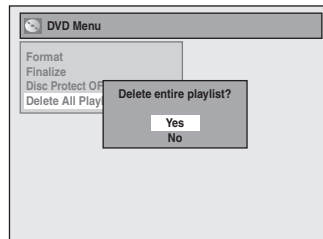

"Are you sure?" will appear.  
Use [▲ / ▼] to select "Yes" and then press  
[ENTER]

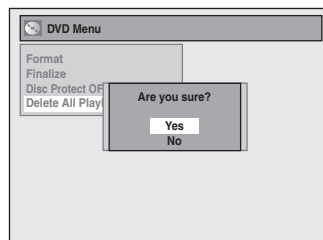

Playlist is deleted.

Writing on the disc starts.  
It may take awhile to write the data on a disc.

### Note

- Deleting a playlist will not increase the available recording time on the disc.

## Putting Names on Titles

You can put a name on the disc and change it from this menu.

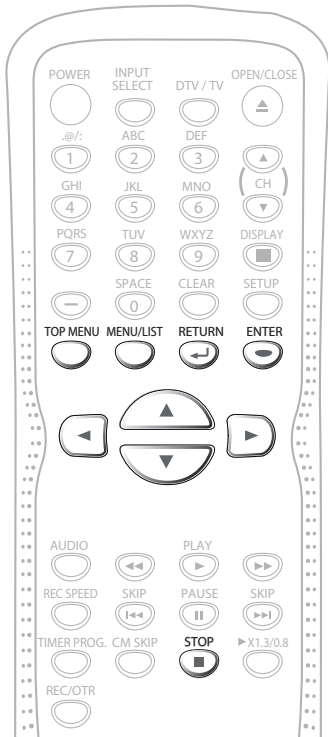

### 1 In stop mode, press [TOP MENU].

Title list, original or playlist will appear.

- For DVD-RW VR mode, press [MENU/LIST] to switch between "Original" and "Playlist" if the disc is recorded in VR mode.

### 2 Use [▲ / ▼ / ◀ / ▶] to select a desired title, then press [ENTER].

e.g.) VR mode DVD-RW original



### 3 Use [▲ / ▼] to select "Edit", then press [ENTER].

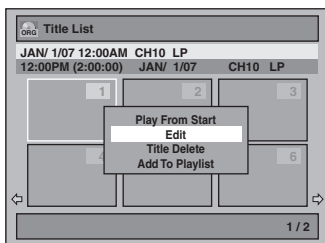

### 4 Use [▲ / ▼] to select "Edit Title Name", then press [ENTER].

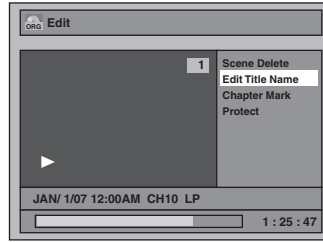

### 5 To enter a title name, follow the steps of "Guide to Edit Title Name" on page 70.

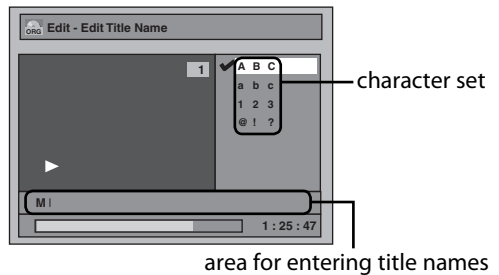

When you finish entering a title name, press [ENTER].

### 6 Use [▲ / ▼] to select "Yes", then press [ENTER].



The name you entered will be activated for the title.

### 7 Press [RETURN ↵] and then [RETURN ↵] or [STOP ■] to exit.

Data will be written onto the disc momentarily.

**This operation may take awhile to be completed.**

## Putting Names on Titles (cont'd)

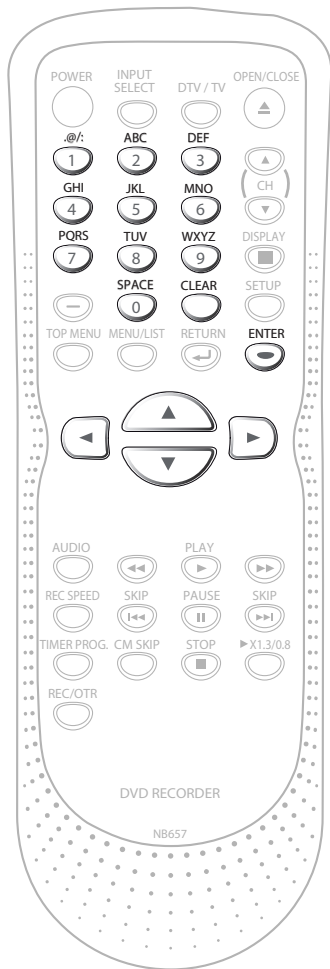

### Guide to Edit Title Name

- 1) Use [▲ / ▼] to select a desired character set, then press [ENTER].
- 2) Follow the list below, use [the Number buttons] repeatedly until the desired letter appears.

Select Press	ABC	abc	123	@!?
0	<space>	<space>	0	<space>
1	(*1)	(*1)	1	!"#\$%&'()* *+,-./:;<=> ?@[ ]^_`{ }
2	ABC	abc	2	(*2)
3	DEF	def	3	(*2)
4	GHI	ghi	4	(*2)
5	JKL	jkl	5	(*2)
6	MNO	mno	6	(*2)
7	PQRS	pqrs	7	(*2)
8	TUV	tuv	8	(*2)
9	WXYZ	wxyz	9	(*2)

- \*1 Press **1**, character set will be changed to the "@!?" mode automatically.
- \*2 Press **2** to **9**, character set will be changed to the previous input mode automatically.
  - To delete letters, press [CLEAR] repeatedly. Press and hold [CLEAR] to delete all letters.
  - Use [◀ / ▶] to move the cursor to the left and right.
  - You can enter up to 30 letters.

### Note

- Undefined letters in a title name are shown by " \* ". If you delete them, adjoining letters may change to " \* " or other.

## Setting or Clearing Chapter Marks



You can put chapter marks in each title. Once a chapter is marked, you can use it for the chapter search feature.

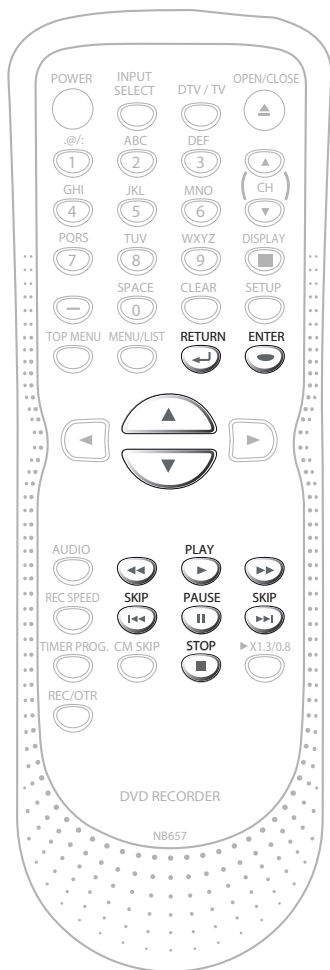

- 1** Follow steps 1 to 3 in “Putting Names on Titles” on page 69 to display “Edit” menu.
- 2** Use [▲ / ▼] to select “Chapter Mark”, then press [ENTER].  
Submenu will appear.
- 3** Use [SKIP ◀◀ / ▶▶], [REV ◀◀], [FWD ▶▶], [PLAY ▶] and [PAUSE II] to find the point where you will create a new chapter mark. Or, use [SKIP ◀◀ / ▶▶] to find a chapter mark that you wish to delete.
- 4** Use [▲ / ▼] to select “Add” or “Delete”, then press [ENTER].  
e.g.) VR mode DVD-RW original

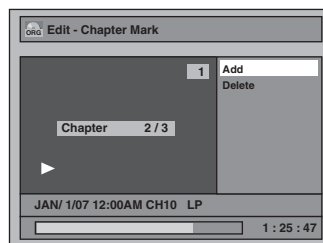

- 5** Use [▲ / ▼] to select “Yes”, then press [ENTER].  
If you select “Add” at step 4, a new chapter mark will be added, and if you select “Delete” at step 4, the chapter mark will be deleted. e.g.) Add

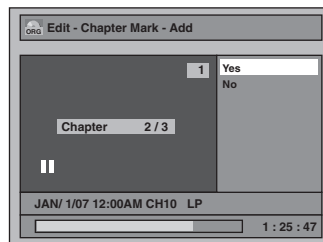

A new chapter mark will be added.

- 6** Press [RETURN ↵].
- 7** Press [RETURN ↵] again and then [RETURN ↵] or [STOP ■] to exit.  
Data will be written onto the disc momentarily.

**This operation may take awhile to be completed.**

### Note

- The maximum number of chapter for VR mode DVD-RW is 999 chapters per entire original and playlist.
- Besides the above-mentioned, it is not likely to be able to add according to recorded time and number of chapters.

## Deleting a Part of a Title



You can delete a specific part of a title.  
Even when parts of title are deleted from the playlist, the original title will remain as it is.

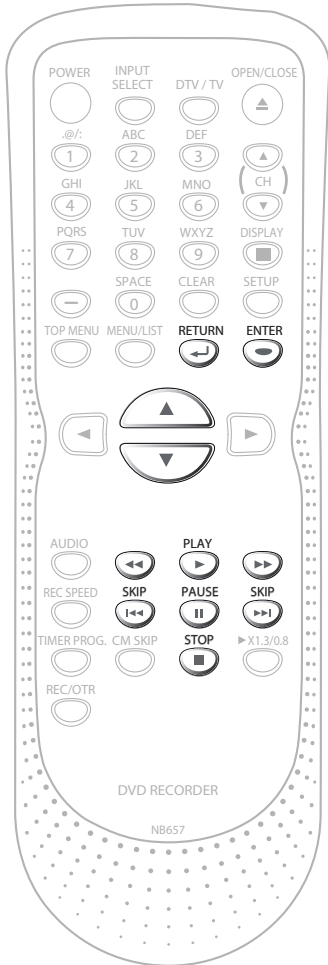

**3** Use [SKIP |◀◀ / ▶▶|], [REV ◀◀], [FWD ▶▶], [PLAY ▶] and [PAUSE ||] to find the start point, then press [ENTER].

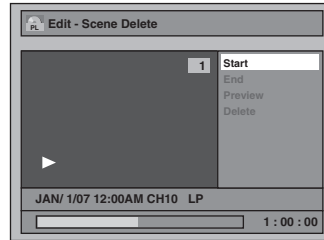

Then use [SKIP |◀◀ / ▶▶|], [REV ◀◀], [FWD ▶▶], [PLAY ▶] and [PAUSE ||] again to move to the end point, and press [ENTER].

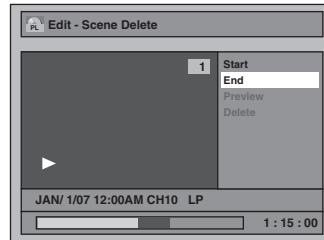

The cursor will move to "Preview".  
The bar at the bottom of the screen indicates the total and the elapsed time of the title, and the area selected for deletion is indicated in red.

You can check the preview by pressing [ENTER].

- Before and after 5 seconds of the deleted point will be playback for preview.

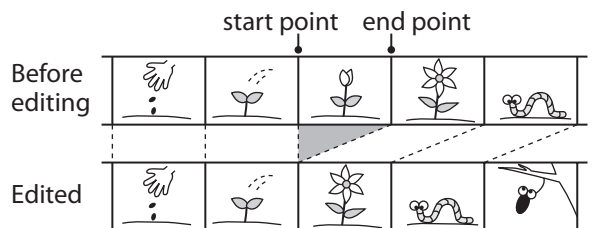

**1** Follow the steps 1 to 3 in "Putting Names on Titles" on page 69 to display the "Edit" menu.

**2** Use [▲ / ▼] to select "Scene Delete", then press [ENTER].  
e.g.) VR mode DVD-RW playlist.

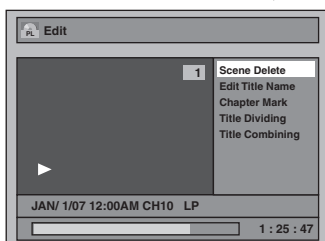

## 4 Use [▲ / ▼] to select “Delete” then press [ENTER].

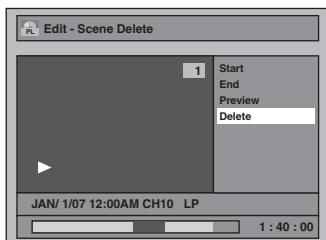

## 5 Use [▲ / ▼] to select “Yes” then press [ENTER].

“Are you sure?” will appear. Select “Yes” using [▲ / ▼] and then press [ENTER].

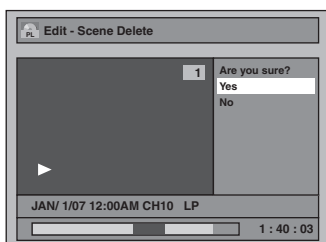

The part of the title is deleted.

## 6 Press [RETURN ↵] and then [RETURN ↵] or [STOP ■] to exit.

Data will be written onto the disc momentarily.

**This operation may take awhile to be completed.**

### Note

- When a scene is deleted from an original, the scene on the playlist will also be deleted.
- You cannot select “Scene Delete” if the number of chapter marks in the original or playlist is more than 999.
- The recordable disc space will not increase even after deleting a part of a title on the playlist.

## Dividing a Title



You can divide one title into 2 new titles.

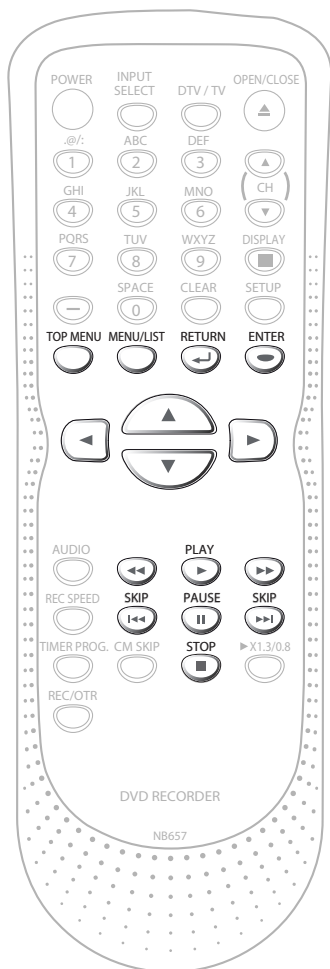

- 1** In stop mode, press [TOP MENU].
  - For VR mode DVD-RW, press [MENU/LIST] to select "Playlist".

---

- 2** Use [▲ / ▼/◀ / ▶] to select a desired title, then press [ENTER].

---

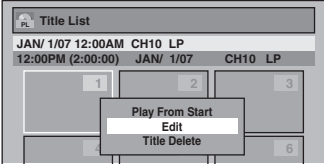
- 3** Use [▲ / ▼] to select "Edit", then press [ENTER].  
 e.g.) VR mode DVD-RW playlist
 

---

- 4** Use [SKIP ◀◀], [SKIP ▶▶], [REV ◀◀], [FWD ▶▶], [PAUSE ||] and [PLAY ▶] to decide the point at which you will divide the title.

---

- 5** Use [▲ / ▼] to select "Title Dividing", then press [ENTER].

---

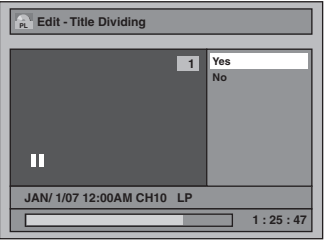
- 6** Use [▲ / ▼] to select "Yes", then press [ENTER].
 

The title will be divided into 2 new titles.  
Both title names are identical.

- 7** Press [RETURN ←] or [STOP ■] to exit.  
 Data will be written onto the disc momentarily.



**This operation may take awhile to be completed.**

### Note

- You cannot divide a title of the disc when the number of recording titles reaches the maximum of 99, and the number of recording chapters reaches the maximum of 999.

## Combining Titles



You can combine 2 titles into a single title.

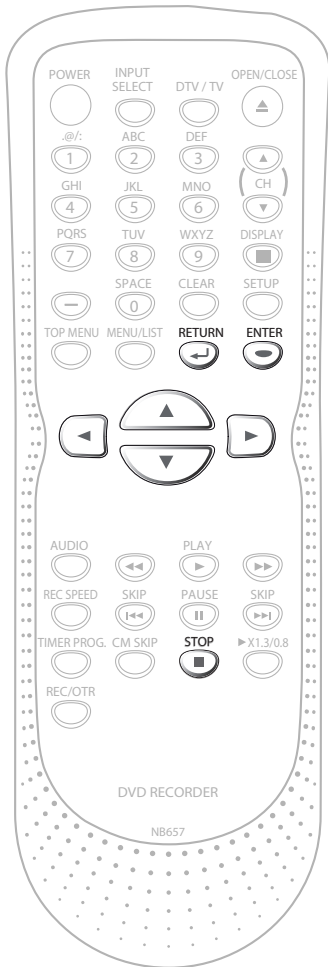

**1** Follow the steps 1 to 3 in “Dividing a Title” on page 74 to display “Edit” menu.

**2** Use [▲ / ▼] to select “Title Combining”, then press [ENTER].

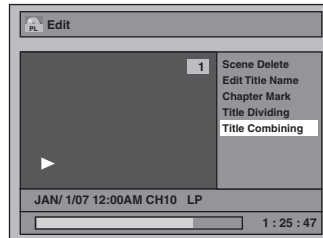

Title combining setting window will appear. Selected title grays out, and the frame of the next title becomes yellow.

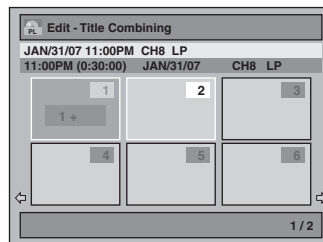

**3** Use [▲ / ▼ / ◀ / ▶] to select another title to combine, then press [ENTER].

**4** Use [▲ / ▼] to select “Yes”, then press [ENTER].

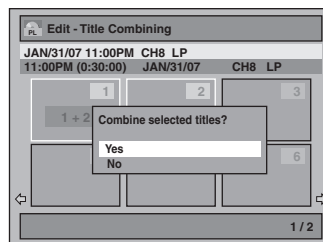

The 2 titles will combine into a single title.

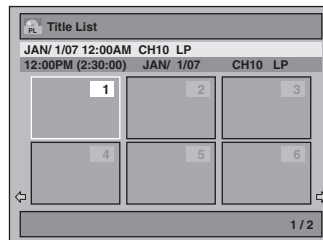

**5** Press [RETURN ←] or [STOP ■] to exit. Data will be written onto the disc momentarily.

**This operation may take awhile to be completed.**

### Note

- You cannot select the same title twice and combine it into a single title.
- If either one of the 2 original titles is deleted, the combined new title is also deleted.

## Setting or Releasing the Title Protection



To prevent the accidental editing, or erasing of the titles, you can protect them in "Edit" menu.

You can cancel the title protection feature after it is applied.

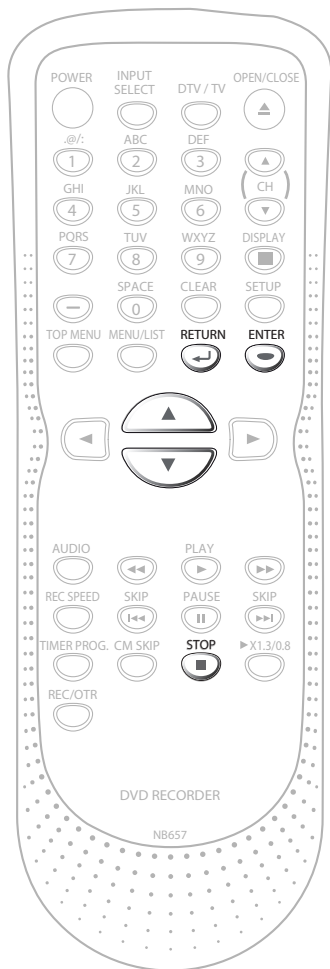

**1** Follow the steps 1 to 3 in "Putting Names on Titles" on page 69 to display "Edit" menu.

**2** Use [▲ / ▼] to select "Protect", then press [ENTER].

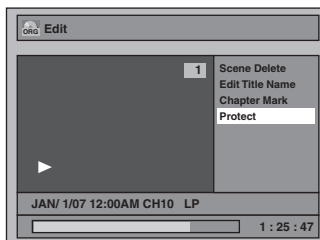

- If the title is protected, will appear in the original list.

**3** Confirm the indication "OFF ⇒ ON". Press [ENTER] again.

- If the title is already protected, "ON ⇒ OFF" will appear. If you press [ENTER], the title will be released from protection.

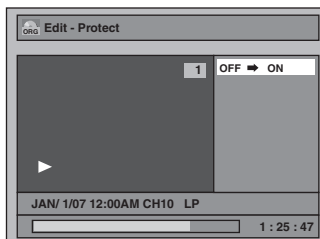

- will appear on the title in the original list.

**4** Press [RETURN ←] and then [RETURN ←] or [STOP ■] to exit.

Data will be written onto the disc momentarily.

**This operation may take awhile to be completed.**

### To protect a whole disc (VR mode DVD-RW only):

Select "Disc Protect OFF ⇒ ON" from the DVD Menu, then select "Yes".

Refer to "SETTING A DISC TO PROTECT" on page 37.

## Setting or Clearing All Chapter Marks at Once



For titles in video mode DVD-RW, you can set or edit chapter at every time interval. You can clear the chapter mark too.

You can specify the interval of chapter marks for titles last more than 5 minutes.

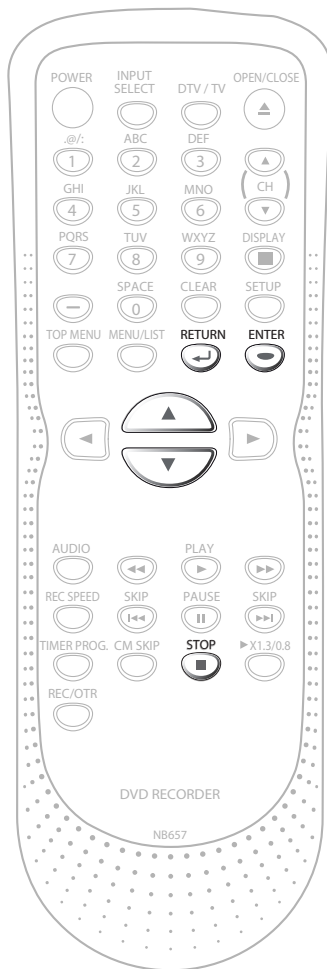

**1** Follow the steps 1 to 3 in “Putting Names on Titles” on page 69 to display “Edit” menu.

**2** Use [▲ / ▼] to select “Chapter Mark”, then press [ENTER].

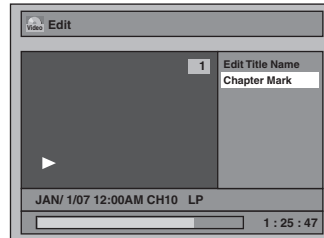

**3** Use [▲ / ▼] to select the desired interval, then press [ENTER].

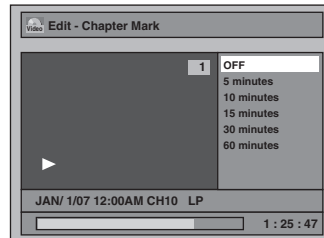

**4** Use [▲ / ▼] to select “Yes”, then press [ENTER].

Chapter marks are added.

If you select “OFF” at step 3, all the chapter marks are erased.

**5** Press [RETURN ←] and then [RETURN ←] or [STOP ■] to exit.

Data will be written onto the disc momentarily.

**This operation may take awhile to be completed.**

### Note

- You cannot select a chapter mark interval that exceeds the length of a title.
- The length of chapters may slightly deviate from the one specified at the step 3.
- A chapter mark may be delayed depending on the recording content.
- The maximum number of chapter for video mode DVD is 99 chapters per disc and title.

# LIST OF SETTINGS

The following table is the contents which you can set and the default settings.  
Refer to the following table for useful operation.

Setup	Items (highlight is the default)	Contents		
General Setting	Playback	Parental Lock → page 81	All level 8 to 1	Set the parental level for DVD playback.
	Audio Out → page 82	Dynamic Range Control	ON OFF	Compressing the range of sound volume.
		PCM	48kHz 96kHz	Set whether the sound recorded in 96kHz will be down sampled in 48kHz.
		Dolby Digital	PCM Stream	Set the type of sound signal which outputs from the digital audio output jack.
	Disc Menu Language → page 82	English French Spanish Other	Set the language for disc menu language.	
	Audio Language → page 82	Original English French Spanish Other	Set the language for audio.	
	Subtitle Language → page 83	OFF English French Spanish Other	Set the language for subtitles.	
	Angle Icon → page 83	ON OFF	Set whether to display the angle icon or not.	
Still Mode → page 83	Auto Field Frame	Set the type of still image in pausing playback.		
Display	OSD Language → page 85	English Français Español	Set the language for OSD (on-screen display).	
	Screen Saver → page 85	OFF 5minutes 10minutes 15minutes 30minutes	Set the idling time before the screen saver starts.	
	FL Dimmer → page 85	Auto Bright Dark	Set the brightness of the front panel display.	
	CC Style	DTV CC → page 31	OFF Service1 Service2 Service3 Service4 Service5 Service6	Set the type of the DTV closed caption.
			User Setting → page 32	ON OFF
		Font Size → page 33	Middle Large Small	Set font size of the displayed caption.
		Font Style → page 33	Style1 Style2 Style3 Style4 Style5 Style6 Style7 Style8	Set font style of the displayed caption.
		Edge Type → page 33	None Raised Depressed Uniform L.Shadow R.Shadow	Set edge type of the displayed caption.

# LIST OF SETTINGS

Setup	Items (highlight is the default)		Contents	
General Setting	Display	CC Style	Solid Translucent Flash	Set the font opacity of the displayed caption.
		Font Opacity → page 33	Transparent White Black Red Green Blue Yellow Magenta Cyan	Set the font color of the displayed caption.
		Font Color → page 33	Solid Translucent Flash	Set back opacity of the displayed caption.
		Back Opacity → page 33	Transparent White Black Red Green Blue Yellow Magenta Cyan	Set back color of the displayed caption.
		Back Color → page 33	Downloadable Rating Change Password	Download rating system via digital broadcasting.
	V-Chip → page 85			
	Video	Progressive → page 87	ON OFF	Set to the progressive scan mode (set to "ON") or to the interlace scan mode(set to "OFF").
		TV Aspect → page 87	4:3 Letter Box 4:3 Pan & Scan 16:9 Wide	Set a picture size according to aspect ratio of your TV.
		Select Video → page 48	L1(Rear) L2(Front)	Video In S-Video In Video In S-Video In
	Recording	Auto Chapter → page 36	OFF 5 minutes 10 minutes 15 minutes 30 minutes 60 minutes	Insert chapter marks at even time interval.
Auto Finalize → page 38		Disc Full End of Timer Rec	ON OFF ON OFF	Set the unit to finalize the disc automatically.
Aspect Ratio(Video mode) → page 36		Auto 4:3 16:9	Set a aspect ratio for video mode recording.	
Clock	Clock Setting → page 27	OFF Auto Manual	Set the clock. Set the clock automatically.	
	Auto Clock Setting → page 26	ON(MAR-NOV) ON(APR-OCT) OFF	Set the clock for the daylight saving time.	
	Daylight Saving Time → page 27			
Channel	Auto Preset → page 23	Air Cable	Tune the channels automatically.	
	Manual Preset → pages 24-25	Stereo SAP	Tune the channels manually. Set the analog TV audio type for output and video mode recording.	
	TV Audio Select → page 30			
Reset All → page 88		Yes No	Set to the default setting.	

## Note

- Your change to each settings stays on even when the power is off.
- An item which is not currently available is grayed in the settings.
- **"Make Recording Compatible" in "Recording" menu does not work on this unit.**

# SETUPS

## Playback

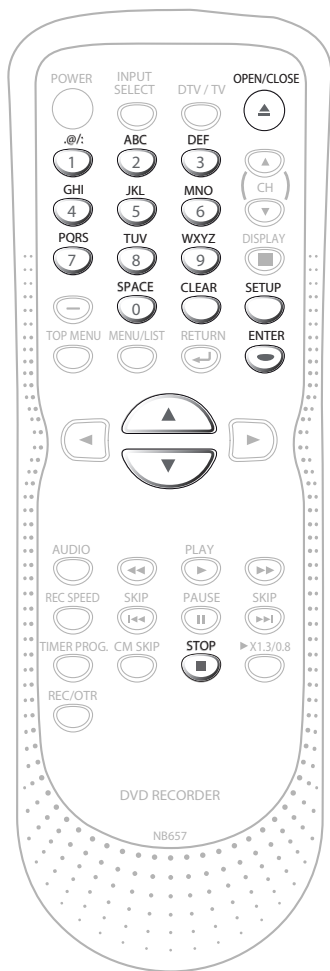

Press [STOP ■] if you are playing back a disc.

**1** Press [SETUP] and use [▲ / ▼] to select "General Setting", then press [ENTER].

**2** Use [▲ / ▼] to select "Playback", then press [ENTER].

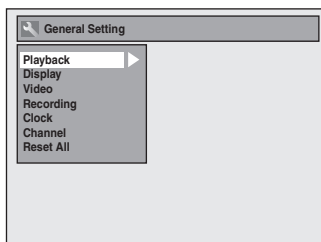

**3** Use [▲ / ▼] to select a desired item, then press [ENTER].

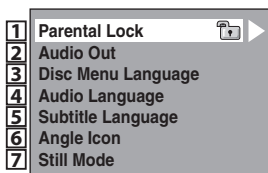

Submenu will appear.

**4** Refer **1** to **7** on pages 81 to 83 and set the selected item.

**5** When you finish with the setting, press [SETUP] to exit.

## Playback (cont'd)

### 1 Parental Lock (Default: All)

Some DVD-video feature a parental lock level. Playback will stop if the ratings exceed the levels you set, it will require you to enter a password before the disc will playback. This feature prevents your children from viewing inappropriate material.

Use **[▲ / ▼]** to select the desired level, then press **[ENTER]**.

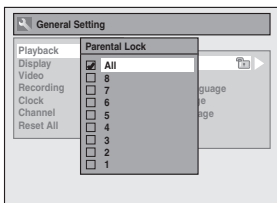

If a password has not been set yet, proceed to **A**.

If a password has been set already, proceed to **B**.

#### Note

- Parental lock function may not be available to some discs.
- With some DVD, it may be difficult to find if they are compatible with parental lock. Be sure to check if the parental lock function operates in the way that you have set.
- Record the password in case you forget it.
- If there is a DVD in the unit when you set up the parental lock, press **[OPEN/CLOSE ▲]** to activate the parental lock level.

**A** A password has not been set yet.

Use **[▲ / ▼]** to select "Yes", then press **[ENTER]**. Use **[the Number buttons]** to enter a new password except for 4737, then press **[ENTER]**.

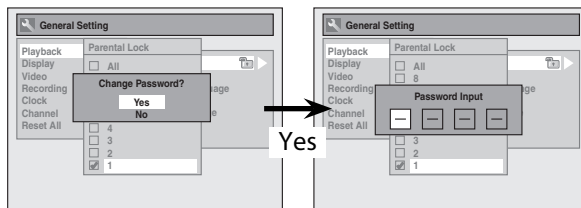

Your setting will be activated.

**B** A password has been set already.

• Use **[the Number buttons]** to enter the current password.

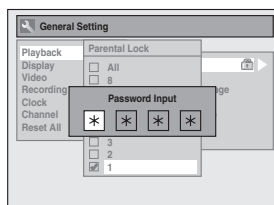

Your setting will be activated.

• If you want to change password, use **[▲ / ▼]** to select "Yes" then press **[ENTER]**. Use **[the Number buttons]** to enter a new password, then press **[ENTER]**.

<change the password>

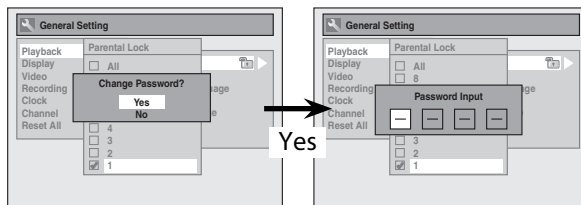

Your setting will be activated.

#### Note

- Press **[CLEAR]** to erase numbers entered incorrectly.
- When you forget the password or you want to clear all settings in "Parental Lock" menu, enter 4,7,3,7 using **[the Number buttons]** in password input window. Password will be cleared and parental levels will be set to "All".

## Playback (cont'd)

### 2 Audio Out

Choose the appropriate audio setting for your external device.  
It will only affect a disc playback.

Use [▲ / ▼] to select a desired item, then press [ENTER].

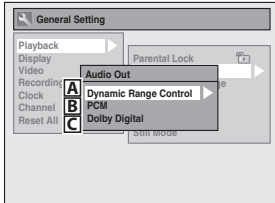

### A Dynamic Range Control (Default : ON)

Set to "ON" to compress the range between soft and loud sounds.

Use [▲ / ▼] to select a setting, then press [ENTER].

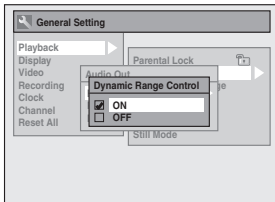

Your setting will be activated.

#### Note

- Dynamic range control function is available only on the discs which are recorded in the Dolby Digital format.

### B PCM (Default : 48kHz)

Use [▲ / ▼] to select a setting, then press [ENTER].

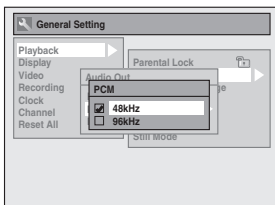

Your setting will be activated.

**48kHz** : If your amplifier/decoder is NOT compatible with 96kHz PCM, select "48kHz". 96kHz sound will be output in 48kHz.

**96kHz** : If your amplifier/decoder is compatible with 96kHz PCM, select "96kHz". 96kHz sound will be output.

#### Note

- When playing back disc with copyright protection
- Even if you select "96kHz", the sound will be down sampled at 48kHz.

### C Dolby Digital (Default : Stream)

Use [▲ / ▼] to select a setting, then press [ENTER].

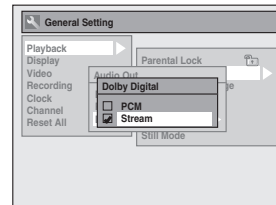

Your setting will be activated.

**PCM** : Converts the Dolby Digital into PCM (2 channel). When your amplifier/decoder is NOT compatible with Dolby Digital, set to "PCM".

**Stream** : Outputs Dolby Digital signals. When your amplifier/decoder is compatible with Dolby Digital, set to "Stream".

### 3 Disc Menu Language (Default : English)

Set the language for disc menu.

Use [▲ / ▼] to select a language, then press [ENTER].

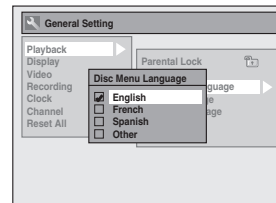

Your setting will be activated.

### 4 Audio Language (Default : Original)

Set the audio language.

Use [▲ / ▼] to select a language, then press [ENTER].

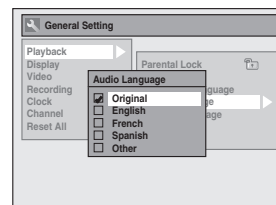

Your setting will be activated.

- When "Original" is selected, the audio language will be in the disc's default language.

## Playback (cont'd)

### 5 Subtitle Language (Default : OFF)

Set the subtitle language.

Use **[▲ / ▼]** to select a language, then press **[ENTER]**.

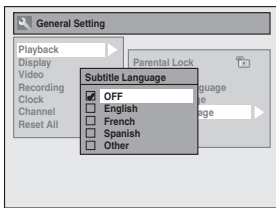

Your setting will be activated.

If "Other" is selected for **[3]** to **[5]**, press 4-digit code using **[the Number buttons]**.

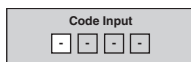

• When you finish entering the code, press **[ENTER]**. Refer to the language code table on page 93.

#### Note

- Only the languages supported by the disc can be selected.
- Audio language setting may not be available to some discs.
- You can change or switch off the subtitles on a DVD also from the disc menu if it is available.
- Press **[CLEAR]** to erase numbers entered incorrectly.

### 6 Angle Icon (Default : ON)

Set to "ON" to show the angle icon during the playback.

Use **[▲ / ▼]** to select a setting, then press **[ENTER]**.

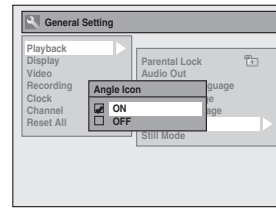

Your setting will be activated.

### 7 Still Mode (Default : Auto)

Select "Auto" usually.

Use **[▲ / ▼]** to select a setting, then press **[ENTER]**.

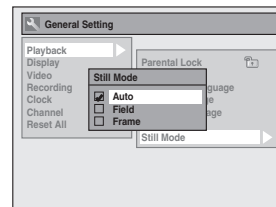

Your setting will be activated.

**Auto** : Optimum resolution setting ("Field" or "Frame") will be selected.

**Field** : Images in the still mode will be stabilized.

**Frame** : Images in the still mode will be highly defined.

#### Note

- Frame is one completed video image made up of 2 fields (There are 30 frames per second of NTSC video).

## Display

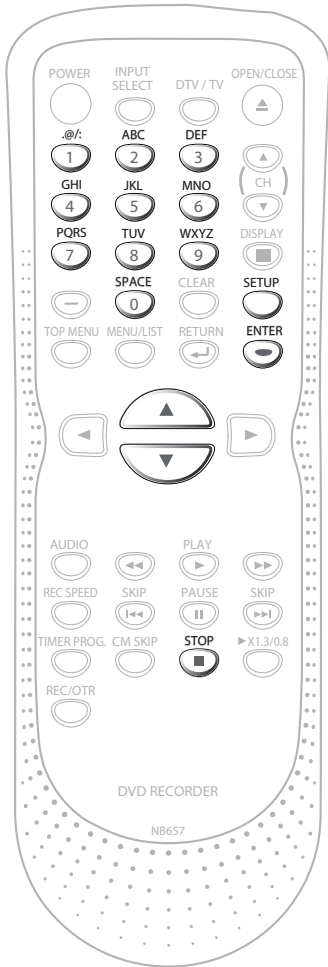

Press [STOP ■] if you are playing back a disc.

**1** Press [SETUP] and use [▲ / ▼] to select "General Setting", then press [ENTER].

**2** Use [▲ / ▼] to select "Display", then press [ENTER].

**3** Use [▲ / ▼] to select a desired item, then press [ENTER].

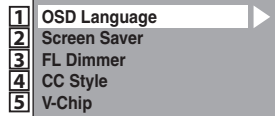

Selection menu will appear.

**4** Refer to **1** to **5** on page 85 and set the selected item.

• For **4** refer to pages 31-33.

**5** When you finish with setting, press [SETUP] to exit.

## Display (cont'd)

### 1 OSD Language (Default : English)

Set the language for the on-screen display.

Use **[▲ / ▼]** to select a setting, then press **[ENTER]**.

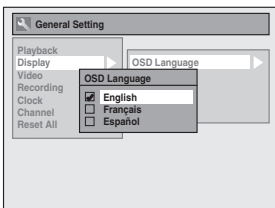

Your setting will be activated.

### 2 Screen Saver (Default : 10 minutes)

Set the time to activate the screen saver function on the TV screen.

Use **[▲ / ▼]** to select a setting, then press **[ENTER]**.

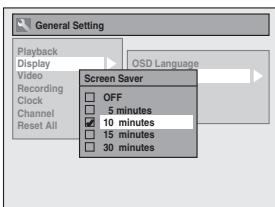

Your setting will be activated.

### 3 FL Dimmer (Default: Bright)

Set the front panel display brightness.

Use **[▲ / ▼]** to select a setting, then press **[ENTER]**.

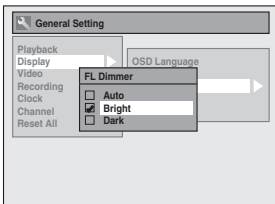

You can choose one from "Auto", "Bright" or "Dark". If "Auto" is selected, the display gets dark when the power is off.

### 5 V-Chip

You can set the viewing limitation for the digital TV programs to prevent your children from watching inappropriate programs.

**This feature is available only after the digital TV ratings have been downloaded.**

- The ratings can be downloaded by the unit automatically if it is available in your area.

### 1) Use [the Number buttons] to enter the access password.

If you have not set the password, first, use **[the Number buttons]** to set the access password, then press **[ENTER]**. The number you entered will be stored as the access password.

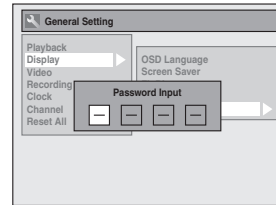

### 2) Use [▲ / ▼] to select a desired item, then press [ENTER].

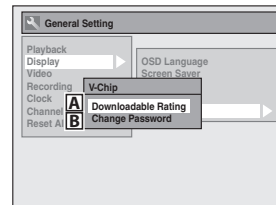

### A Downloadable Rating

Set the rating system via digital broadcasting, or clear the downloaded ratings.

**If the broadcasting signal does not have the downloadable rating information, the message below will appear.**

Downloadable Rating is currently not available.

- This message will also appear when you try to access "DOWNLOADABLE RATING" after you have cleared the downloadable rating information, and the new information has not been downloaded since.

#### To set the rating:

Use **[▲ / ▼]** to select "BLOCK SETTING" then press **[ENTER]** to show the various types of ratings. Use **[▲ / ▼]** to select a desired rating to set, then press **[ENTER]** to show the levels for the rating. Use **[▲ / ▼]** to select a level, then press **[ENTER]** to switch "VIEW" or "BLOCK". If you set one level to "BLOCK", all the higher levels will be turned to "BLOCK" automatically.

#### To clear the downloadable rating information and its setting:

Use **[▲ / ▼]** to select "CLEAR DOWNLOADABLE RATING", then press **[ENTER]**.

### B Change Password

Change the current password.

**Use [the Number Buttons] to enter new access password.**

#### Note

- When you forget the access password at step 1), enter 4,7,3,7 using **[the Number buttons]** in the password input window. Password will be cleared.
- Depending on the type of rating system, you may set the levels individually.

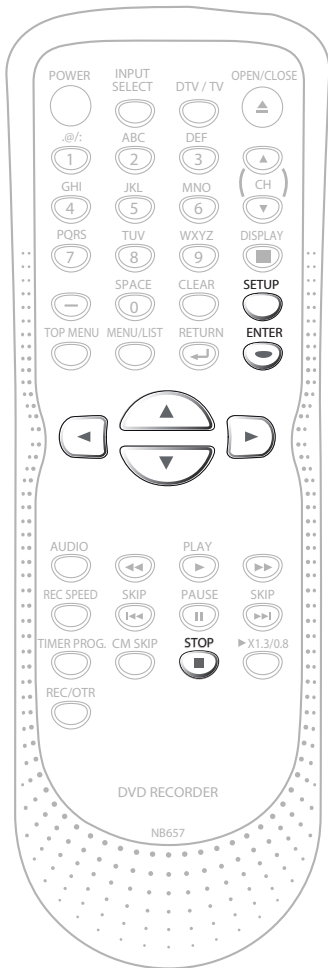

Press [STOP ■] if you are playing back a disc.

**1** Press [SETUP] and use [▲ / ▼] to select "General Setting", then press [ENTER].

**2** Use [▲ / ▼] to select "Video", then press [ENTER].

**3** Use [▲ / ▼] to select a desired item, then press [ENTER].



Submenu will appear.

**4** Refer **1** to **2** on page 87 and set the selected item.

- For **3**, refer to "Connection to an External Device" on page 48.

**5** When you finish with the setting, press [SETUP] to exit.

## Video (cont'd)

### 1 Progressive (Default : OFF)

This unit is compatible with the progressive scan system. The feature provides you with the higher definition images than the traditional output system does. To utilize this feature, you must set progressive scan mode to "ON".

1) Use [▲ / ▼] to select "ON", then press [ENTER].

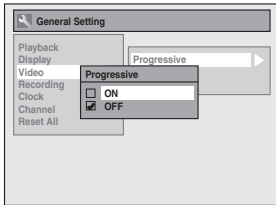

2) Use [◀ / ▶] to select "Yes", then press [ENTER].

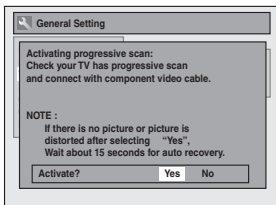

3) Use [▲ / ▼] to select "Yes" within 15 seconds, then press [ENTER].

Your setting will be activated.

#### Note

- If your TV is compatible with progressive scan (525p / 480p), you are recommended to use the component video cable (commercially available) to connect this unit to the TV. (Refer to "Method 3" on page 18.) If not, use the RCA video cable and set the progressive scan to "OFF" or press and hold [SETUP] for more than 3 seconds during DVD playback.
- When selecting "No" or not pressing any buttons on the unit or remote control within 15 seconds at step 3, progressive scan remains to be "OFF" (interlace scan).

### 2 TV Aspect (Default: 4:3 Letter Box)

You can select the TV aspect ratio to match the formats of what you are playing back with the unit and your TV screen (4:3 standard or 16:9 widescreen TV).

Use [▲ / ▼] to select a desired option, then press [ENTER].

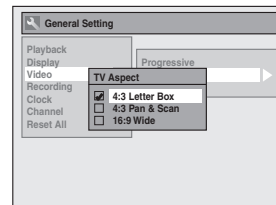

**If you have a standard TV:**

Select "4:3 Letter Box", so that black bars appear on the top and bottom of the TV screen when playing back a wide-screen picture. Select "4:3 Pan & Scan" for a full height picture with both sides trimmed when playing back wide-screen picture.

**If you have a widescreen TV:**

Select "16:9 Wide".

## Reset All

Reset the setting to default.

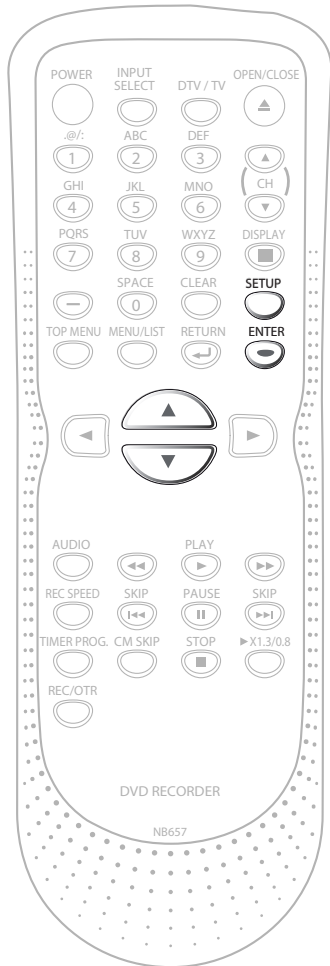

**1** Press [SETUP] in stop mode and use [▲ / ▼] to select "General Setting", then press [ENTER].

**2** Use [▲ / ▼] to select "Reset All", then press [ENTER].

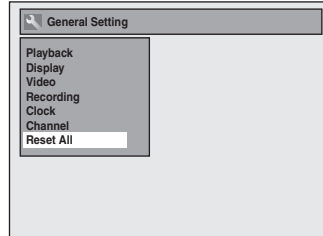

**3** Select "Yes" using [▲ / ▼], then press [ENTER].

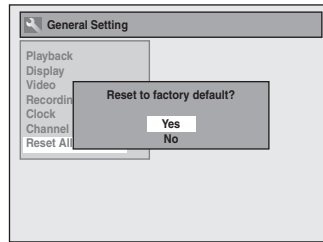

**4** Select "Yes" again using [▲ / ▼], then press [ENTER].

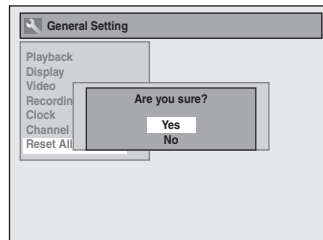

Your setting in recording will be initialized.

### Note

- The settings listed below will remain unchanged even after resetting to the factory default.
  - Clock setting
  - Channel setting
  - OSD language setting
  - Parental lock setting
  - V-Chip setting
  - Timer programs

# TROUBLESHOOTING

Before requesting service for this unit, check the table below for a possible cause of the problem you are experiencing. Some simple checks or a minor adjustment on your part may eliminate the problem and restore proper operation.

Symptom	Remedy
<b>Power</b>	
The power does not turn on.	<ul style="list-style-type: none"> <li>• Check that the AC power cord is connected securely.</li> <li>• Check the breaker (in case of power failure).</li> </ul>
<b>Picture</b>	
There is no picture.	<ul style="list-style-type: none"> <li>• Re-connect the connecting cords securely.</li> <li>• Check if the connecting cords are damaged.</li> <li>• If the main menu appears on the TV screen, press <b>[RETURN ←]</b> to exit.</li> <li>• Check the connection to your TV (page 18).</li> <li>• Check if the progressive scan mode is set correctly according to your TV (page 87).</li> <li>• Switch the input selector on your TV (such as to "L1") so that the signal from the unit appears on the TV screen.</li> </ul>
Picture noise appears.	<ul style="list-style-type: none"> <li>• Clean the disc with a cleaning cloth.</li> </ul>
TV program reception does not fill the TV screen.	<ul style="list-style-type: none"> <li>• Try to set the channels with "Auto Preset" or "Manual Preset" in "Channel" menu (pages 23-25).</li> <li>• Select a channel of any TV program using <b>[CH ▲ / ▼]</b>.</li> </ul>
TV program pictures are distorted.	<ul style="list-style-type: none"> <li>• Adjust TV antenna.</li> <li>• Adjust the picture. (Refer to the TV's instruction manual.)</li> <li>• Place the unit and TV farther apart.</li> <li>• Place the TV and any bunched RF coaxial cables farther apart.</li> </ul>
TV channels cannot be changed.	<ul style="list-style-type: none"> <li>• Switch the input to TV.</li> <li>• Connect the RF coaxial cable correctly (pages 15-17).</li> </ul>
Playback picture is distorted.	<ul style="list-style-type: none"> <li>• Keep the device which may cause electrical disturbances, such as a cellular phone away.</li> </ul>
<b>Sound</b>	
There is no sound.	<ul style="list-style-type: none"> <li>• Clean the disc with a cleaning cloth.</li> <li>• Re-connect all connections securely.</li> <li>• Check if the connecting cord is damaged.</li> <li>• Check the connections to the amplifier input.</li> <li>• Check if the input device setting on the amplifier is correct.</li> <li>• When the unit is in pause mode or in slow-motion playback mode, sound is not output. This is not a malfunction.</li> <li>• When the unit is in fast forward or fast reverse mode, sound is not output. This is not a malfunction.</li> <li>• If you are using COAXIAL DIGITAL AUDIO OUTPUT jack, check the setting in "Audio Out" (page 82).</li> </ul>
No DTS sound is output.	<ul style="list-style-type: none"> <li>• This unit is not compatible with DTS sound.</li> </ul>
Sound is noisy.	<ul style="list-style-type: none"> <li>• Clean the disc with a cleaning cloth.</li> </ul>
<b>Remote control</b>	
The remote control does not function.	<ul style="list-style-type: none"> <li>• Batteries are weak.</li> <li>• There are obstacles between the remote control and the unit.</li> <li>• The remote control is far from the unit.</li> <li>• There are no batteries in the remote control.</li> <li>• Check if the unit is turned on.</li> <li>• Check if you are pointing the remote control at the recorder and NOT the TV. If you have a plasma TV, it may interfere with the IR signal. Try the remote with the plasma off. If the remote works, you may need to move the unit away from the plasma TV.</li> </ul>

# TROUBLESHOOTING

Symptom	Remedy
<b>Playback</b> The disc does not play back.	<ul style="list-style-type: none"> <li>• No disc is inserted.</li> <li>• A blank disc is inserted.</li> <li>• The disc is upside down. Insert the disc with the labeled side facing up.</li> <li>• The disc is not correctly inserted.</li> <li>• The unit cannot play back certain discs (such as a CD-ROM) (page 9).</li> <li>• The region code on the DVD-video does not match the unit (page 9).</li> <li>• Moisture has condensed inside the unit. Remove the disc and leave the unit turned on for about 2 hours until the moisture evaporates (page 4).</li> <li>• If the disc was recorded on another recorder, the unit cannot play back the disc if it was not finalized.</li> </ul>
The disc does not start playback from the beginning.	<ul style="list-style-type: none"> <li>• Resume playback was activated (page 55). Press <b>[STOP ■]</b> twice.</li> <li>• You have inserted a disc whose title menu or DVD menu automatically appears on the TV screen when it is first inserted.</li> </ul>
The unit starts playing back the disc automatically.	<ul style="list-style-type: none"> <li>• The DVD-video features an auto playback function.</li> </ul>
Some functions such as stop, search, or slow-motion playback cannot be performed.	<ul style="list-style-type: none"> <li>• Depending on the disc, you may not be able to do some of the operations. Refer to the instruction manual supplied with the disc.</li> </ul>
The language for the sound track cannot be changed.	<ul style="list-style-type: none"> <li>• Tracks multilingual are not recorded being played back.</li> <li>• The DVD-video prohibits the changing of the language for the sound track.</li> </ul>
The subtitle language cannot be changed or turned off.	<ul style="list-style-type: none"> <li>• Multilingual subtitle are not recorded on the DVD-video.</li> </ul>
The angles cannot be changed.	<ul style="list-style-type: none"> <li>• Multi-angles are not recorded on the DVD-video being played back.</li> <li>• The angle-change operation is whenever possible as long as the disc contains a multi-angle portion. Actual change will be performed when the portion has come up.</li> <li>• The DVD-video prohibits changing angles.</li> <li>• Try changing the angle using the DVD-video's menu.</li> </ul>
<b>Recording / Timer recording / Editing</b>	
The channel cannot be changed from the channel you are recording.	<ul style="list-style-type: none"> <li>• Set the TV's input to "TV."</li> </ul>
Nothing was recorded even though you set the timer setting correctly.	<ul style="list-style-type: none"> <li>• There was a power failure during recording.</li> <li>• The unit's internal clock stopped due to a power failure that lasted for more than 30 seconds. Reset the clock (pages 26-27).</li> <li>• The program contains copy protection signals that restricts copying.</li> <li>• The timer setting overlapped with another setting that has priority.</li> </ul>
Recording does not stop immediately after you press <b>[STOP ■]</b> .	<ul style="list-style-type: none"> <li>• It will take a few seconds for the unit to input disc data before recording stops.</li> </ul>
Timer recording is not complete or did not start from the beginning.	<ul style="list-style-type: none"> <li>• The timer setting overlapped with another setting that has priority (page 47).</li> <li>• Disc space was not enough.</li> </ul>

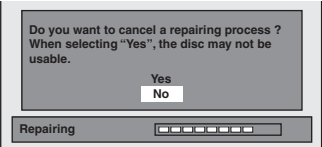
Symptom	Remedy
<b>Others</b>	
The unit does not operate properly.	<ul style="list-style-type: none"> <li>When static electricity, etc., causes the unit to operate abnormally, unplug the unit and then plug it in again.</li> </ul>
The disc tray does not open when you press <b>[OPEN/CLOSE ▲]</b> .	<ul style="list-style-type: none"> <li>It may take a few seconds for the disc tray to open after you have recorded or edited a disc. This is because the unit is adding disc data to the disc.</li> </ul>
“Repairing” appears on the TV screen.	<ul style="list-style-type: none"> <li>If there is a power failure or unplugging during recording, finalizing, formatting or editing (even after “Repairing” disappears), a repairing process will begin automatically just after turning the unit on again. It may take several minutes up to about several hours.</li> </ul>
 <p>In a case you intend to cancel the repairing process.</p> 	<ul style="list-style-type: none"> <li>If you intend to cancel the repairing process, press <b>[OPEN/CLOSE ▲]</b> on the front panel, then select “Yes” and press <b>[ENTER]</b>. After that, press <b>[OPEN/CLOSE ▲]</b> to take out the disc. <b>The disc canceled during the repairing process MAY NOT work.</b></li> </ul>

## Frequently Asked Questions

– Can I record to CD-RW/-R?	No, this unit records only DVD.
– Can I play back DVD-video that is bought in another country?	Possible when the region code of the disc is 1 and All.
– Can I connect the unit to my PC?	No, you cannot control the unit by PC.
– Can I program a timer recording with cable/satellite box?	Yes, you can. Select “L1” or “L2” as your recording channel, and leave the cable/satellite box on (pages 17, 44-47).
– Can I record one channel while watching another channel using a cable / satellite box?	It depends on your connection configurations. For more details, please kindly contact your cable / satellite provider.
– Can I connect this unit directly to a TV which only has an antenna in jack using an RF coaxial cable?	No. You need an RF modulator (commercially available) to connect this unit to a TV which only has an antenna in jack (page 16). This unit does not have an RF modulator.
– Can I change the channels on the cable / satellite box using the remote control of this unit?	No. Changing the channels on the cable / satellite box using this unit’s remote control is not possible. You need to use the remote control supplied with the cable / satellite box to change the channels on the cable / satellite box.

# TROUBLESHOOTING

Error message	Cause	Solution
Disc Error — Please eject the disc. — Playback feature may not be available on this disc.	<ul style="list-style-type: none"> <li>Unplayable disc is inserted in the unit.</li> <li>The disc is upside down.</li> </ul>	<ul style="list-style-type: none"> <li>Insert the standardized disc which have the marks on pages 8-9.</li> <li>Insert the disc with the labeled side facing up.</li> </ul>
Region Error — Please eject the disc. — Playback is not authorized in your region.	<ul style="list-style-type: none"> <li>Playback is not authorized in the region of the DVD-video which you inserted in the unit.</li> </ul>	<ul style="list-style-type: none"> <li>Insert the DVD-video with region codes 1 or ALL.</li> </ul>
Parental Lock On The current selected parental level prohibits playback.	<ul style="list-style-type: none"> <li>The current selected parental level prohibits playback.</li> </ul>	<ul style="list-style-type: none"> <li>Check "Parental Lock" setting in "Playback" menu (page 81).</li> </ul>
Recording Error This program is not allowed to be recorded.	<ul style="list-style-type: none"> <li>You are trying to record the copy prohibited program.</li> </ul>	<ul style="list-style-type: none"> <li>You cannot record copy prohibited programs.</li> </ul>
Recording Error This program is not recordable in Video mode.	<ul style="list-style-type: none"> <li>You are trying to record the copy-once program onto the DVD-RW disc in video mode.</li> </ul>	<ul style="list-style-type: none"> <li>Set "Format Mode" to "VR mode" (page 34).</li> </ul>
Recording Error Cannot record on this disc.	<ul style="list-style-type: none"> <li>You are trying to record onto the disc which is unrecordable, or the disc status is unable to record.</li> <li>The disc is dirty.</li> <li>The disc is damaged.</li> </ul>	<ul style="list-style-type: none"> <li>Insert the recordable disc, and ensure the disc status satisfies the recording requirements (page 8).</li> <li>Clean the disc with a cleaning cloth.</li> <li>Replace the disc.</li> </ul>
Recording Error This program is not allowed to be recorded on this disc.	<ul style="list-style-type: none"> <li>You are trying to record the copy-once program onto the DVD-RW disc which is not compatible with CPRM.</li> </ul>	<ul style="list-style-type: none"> <li>Insert the DVD-RW disc in VR mode (ver.1.1 or 1.2 compatible with CPRM).</li> </ul>
Recording Error This disc is protected and not recordable.	<ul style="list-style-type: none"> <li>You are trying to record on to the protected disc which is set in "DVD Menu" menu.</li> </ul>	<ul style="list-style-type: none"> <li>Release the disc protect setting in "DVD Menu" menu (page 37).</li> </ul>
Recording Error Disc is full. (No area for new recording)	<ul style="list-style-type: none"> <li>You are trying to record onto the disc which has no space for recording.</li> </ul>	<ul style="list-style-type: none"> <li>Insert the recordable disc with enough recording space.</li> </ul>
Recording Error You cannot record more than 99 titles on one disc. (The maximum is 99)	<ul style="list-style-type: none"> <li>You are trying to record onto the DVD-RW/-R on which the number of recording titles comes up to the maximum (99).</li> </ul>	<ul style="list-style-type: none"> <li>Delete unnecessary titles (page 66).</li> </ul>
Recording Error You cannot record more than 999 chapters on one disc. (The maximum is 999)	<ul style="list-style-type: none"> <li>You are trying to record onto the VR mode DVD-RW on which the number of recording chapters comes up to the maximum (999).</li> </ul>	<ul style="list-style-type: none"> <li>Delete unnecessary chapter marks (pages 71).</li> </ul>
Recording Error You cannot record on this disc as Control Information is full.	<ul style="list-style-type: none"> <li>This disc has no space to write the Control Information when recording or deleting contents. When editing has been repeatedly performed, the control Information area may come up to be full even the recording area has enough space.</li> </ul>	<ul style="list-style-type: none"> <li>Delete unnecessary titles (page 66).</li> </ul>
Recording Error You cannot record on this disc as Power Calibration Area is full.	<ul style="list-style-type: none"> <li>When recordings are performed repeatedly onto an unstable disc, this area may come up to be full.</li> <li>Every time you insert a disc for recording, the disc's working area will be taken up. And if you repeat this frequently, it will be used up sooner and you may not be able to record full 99 titles.</li> </ul>	<ul style="list-style-type: none"> <li>Insert a new disc.</li> </ul>
Recording Error This disc is already finalized.	<ul style="list-style-type: none"> <li>You are trying to record onto the disc already finalized.</li> </ul>	<ul style="list-style-type: none"> <li>Undo the finalizing for this disc (pages 39-40).</li> </ul>

\* If you are still having trouble with the unit after checking "TROUBLESHOOTING", write down the error code and the error description for calling our help line to locate an Authorized Service Center.

# LANGUAGE CODE

Language	Code	Language	Code	Language	Code
Abkhazian	4748	Hungarian	5467	Russian	6467
Afar	4747	Icelandic	5565	Samoaan	6559
Afrikaans	4752	Indonesian	5560	Sangho	6553
Albanian	6563	Interlingua	5547	Sanskrit	6547
Amharic	4759	Interlingue	5551	Scots Gaelic	5350
Arabic	4764	Inupiak	5557	Serbian	6564
Armenian	5471	Irish	5347	Serbo-Croatian	6554
Assamese	4765	Italian	5566	Sesotho	6566
Aymara	4771	Japanese	5647	Setswana	6660
Azerbaijani	4772	Javanese	5669	Shona	6560
Bashkir	4847	Kannada	5760	Sindhi	6550
Basque	5167	Kashmiri	5765	Singhalese	6555
Bengali; Bangla	4860	Kazakh	5757	Siswat	6565
Bhutani	5072	Kinyarwanda	6469	Slovak	6557
Bihari	4854	Kirghiz	5771	Slovenian	6558
Bislama	4855	Kirundi	6460	Somali	6561
Breton	4864	Korean	5761	Spanish	5165
Bulgarian	4853	Kurdish	5767	Sundanese	6567
Burmese	5971	Laothian	5861	Swahili	6569
Byelorussian	4851	Latin	5847	Swedish	6568
Cambodian	5759	Latvian; Lettish	5868	Tagalog	6658
Catalan	4947	Lingala	5860	Tajik	6653
Chinese	7254	Lithuanian	5866	Tamil	6647
Corsican	4961	Macedonian	5957	Tatar	6666
Croatian	5464	Malagasy	5953	Telugu	6651
Czech	4965	Malay	5965	Thai	6654
Danish	5047	Malayalam	5958	Tibetan	4861
Dutch	6058	Maltese	5966	Tigrinya	6655
English	5160	Maori	5955	Tonga	6661
Esperanto	5161	Marathi	5964	Tsonga	6665
Estonian	5166	Moldavian	5961	Turkish	6664
Faroese	5261	Mongolian	5960	Turkmen	6657
Fiji	5256	Nauru	6047	Twì	6669
Finnish	5255	Nepali	6051	Ukrainian	6757
French	5264	Norwegian	6061	Urdu	6764
Frisian	5271	Occitan	6149	Uzbek	6772
Galician	5358	Oriya	6164	Vietnamese	6855
Georgian	5747	Oromo (Afan)	6159	Volapuk	6861
German	5051	Panjabi	6247	Welsh	4971
Greek	5158	Pashto; Pushto	6265	Wolof	6961
Greenlandic	5758	Persian	5247	Xhosa	7054
Guarani	5360	Polish	6258	Yiddish	5655
Gujarati	5367	Portuguese	6266	Yoruba	7161
Hausa	5447	Quechua	6367	Zulu	7267
Hebrew	5569	Rhaeto-Romance	6459		
Hindi	5455	Romanian	6461		

Introduction

Connections

Basic Setup

Disc Management

Recording

Playback

Editing

Function Setup

Others

Español

# GLOSSARY

## **Analog Audio**

An electrical signal that directly represents sound. Compare this to digital audio which can be an electrical signal, but is an indirect representation of sound. See also "Digital Audio".

## **Aspect Ratio**

The width of a TV screen relative to its height. Conventional TVs are 4:3 (in other words, the TV screen is almost square); widescreen models are 16:9 (the TV screen is almost twice as wide as it is high).

## **Chapter**

Just as a book is split up into several chapters, a title on a DVD is usually divided into chapters. See also "Title".

## **Component Video Output**

Each signal of luminance (Y) and component (P<sub>B</sub>/C<sub>B</sub>, P<sub>R</sub>/C<sub>R</sub>) is independent to output so that you can experience picture color as it is.

Also, due to compatibility with progressive video (525p/480p), you can experience higher-density picture than that in interlace (525i/480i).

## **Digital Audio**

An indirect representation of sound by numbers. During recording, the sound is measured at discrete intervals (44,100 times a second for CD audio) by an analog-to-digital converter, generating a stream of numbers. On playback, a digital-to-analog converter generates an analog signal based on these numbers. See also "Sampling Frequency" and "Analog Audio".

## **Dolby Digital**

The system to compress digital sound developed by Dolby Laboratories. It offers you sound of stereo(2ch) or multi channel audio.

## **Finalize**

To make DVD, which have been recorded on, possible to play back in DVD players.

## **JPEG (joint photographic experts group)**

JPEG is a method of compressing still image files. You can copy JPEG files on CD-RW/-R from a computer and play back the files on this unit.

## **MP3 (MPEG audio layer 3)**

MP3 is a method of compressing files. You can copy MP3 files on CD-RW/-R from the computer and play back the files on this unit.

## **PCM (pulse code modulation)**

The most common system of encoding digital audio, found on CD and DAT. Excellent quality, but requires a lot of data compared to formats such as Dolby Digital and MPEG audio. For compatibility with digital audio recorders (CD, MD and DAT) and AV amplifiers with digital inputs, this unit can convert Dolby Digital and MPEG audio to PCM. See also "Digital Audio".

## **Progressive Scan (525p/480p)**

A type of display that does not split each frame into fields, and instead scans directly through all the scanlines of each frame in order. Progressive scan provides less flickering and higher image resolution than traditional (525i/480i) TV signals. Refer to page 87 for instructions on selective progressive scan mode.

## **Region Code**

Regions associate discs and players with particular areas of the world. This unit will only play back discs that have compatible region codes. You can find the region code of your unit by looking on the rear panel. Some discs are compatible with more than one region (or all regions).

## **Sampling Frequency**

The rate which sound is measured by a specified interval to turn into digital audio data. The numbers of sampling in one second defines as sampling frequency. The higher the rate, the better the sound quality.

## **SAP (secondary audio program)**

Sub-audio channel which is delivered separately from main-audio channel. This audio channel is used as an alternate in bilingual broadcasting.

## **S-Video Output**

It delivers independently each signal of color(C) and luminance(Y) to TV as video signals, so that higher-quality picture will be gained.

## **Title (DVD only)**

A collection of chapters on DVD. See also "Chapter".

## **Track**

Audio CD use tracks to divide up the content of a disc. The DVD equivalent is called a chapter. See also "Chapter".

# SPECIFICATIONS

- This model complies with the below specifications.
- Designs and specifications are subject to change without notice.
- This model may not be compatible with features and/or specifications that may be added in the future.

General		
System	DVD-RW/-R, DVD-video, CD-DA, CD-RW/-R	
Power requirements	120V AC +/-10%, 60Hz +/-5%	
Power consumption	22W (standby: 2.8W)	
Dimensions (width x height x depth)	16.6 x 2.4 x 9.8 inches (420 x 59 x 247mm)	
Weight	4.7 lbs. ( 2.1kg )	
Operating temperature	41°F (5°C) to 104°F (40°C)	
Operating humidity	Less than 80% (no condensation)	
TV format	ATSC / NTSC-M TV standard	
Recording		
Recording format	VR (video recording) format, video format	
Recording discs	DVD-Rewritable, DVD-Recordable	
Video recording format		
Sampling frequency	13.5 MHz	
Compression format	MPEG	
Audio recording format		
Sampling frequency	48 kHz	
Compression format	Dolby Digital	
Tuner		
Tuning system	Channel frequency synthesized tuning system	
Channel coverage (ATSC / NTSC)		
Terrestrial	VHF 2~13, UHF 14~69	
CATV	2~13, A~W, W+1~W+94 (analog W+1~W+84), A-5~A1, 5A	
Terminals		
Front	<b>Audio input</b> RCA jack x 2	2V rms (input impedance: more than 22kΩ)
	<b>Video input</b> RCA jack x 1	1Vp-p (75Ω)
	<b>S-video input</b> Mini DIN 4-pin x 1	Y: 1Vp-p (75Ω)    C: 286mVp-p (75Ω)
Rear	<b>VHF/UHF/CATV input and output</b> F-type	75Ω unbalanced
	<b>Audio input</b> RCA jack x 2	2V rms (input impedance: more than 22kΩ)
	<b>Audio output</b> RCA jack x 2	2V rms (output impedance: more than 1kΩ)
	<b>Video input</b> RCA jack x 1	1Vp-p (75Ω)
	<b>Video output</b> RCA jack x 1	1Vp-p (75Ω)
	<b>S-video input</b> Mini DIN 4-pin x 1	Y: 1Vp-p (75Ω)    C: 286mVp-p (75Ω)
	<b>S-video output</b> Mini DIN 4-pin x 1	Y: 1Vp-p (75Ω)    C: 286mVp-p (75Ω)
	<b>Component video output</b> RCA jack x 3	Y: 1Vp-p (75Ω)    PB/CB: 700mVp-p (75Ω)    PR/CR: 700mVp-p (75Ω)
	<b>Coaxial digital audio output</b> RCA jack x 1	500mVp-p (75Ω)

Introduction

Connections

Basic Setup

Disc Management

Recording

Playback

Editing

Function Setup

Others

Español

# ESPAÑOL

## Discos grabables y reproducibles

Tipo de disco	DVD-RW		DVD-R
Logotipo			
Formato	Puede formatearse en modo VR o modo de video		Formateado automáticamente en modo de video
Tiempo máximo de grabación	Modo de video	Modo VR	480 minutos (12 centímetros) 144 minutos (8 centímetros)
	480 minutos (12 centímetros) 144 minutos (8 centímetros)	480 minutos (12 centímetros) 144 minutos (8 centímetros)	
Versiones grabables/reproducibles	Versione 1.1,1.2 Versione 1.1/2× CPRM compatible Versione 1.2/4× CPRM compatible		Versione 2.0 Versione 2.0/4× Versione 2.0/8× Versione 2.0/16×
Compatibilidad	Se puede reproducir en la mayoría de los reproductores de DVD. Es necesario finalizar. (se creará el menú de DVD)	Se puede reproducir sólo en unidades compatibles con el modo VR. Se recomienda finalizar.	Se puede reproducir en la mayoría de los reproductores de DVD. Es necesario finalizar. (se creará el menú de DVD)

## Discos reproducibles

Tipo de disco	DVD-VIDEO	CD-DA	CD-RW	CD-R
Logotipo			 	 

## Archivos reproducibles

Título de disco	MP3	JPEG
Medio	CD-RW/-R	CD-RW/-R

 es una marca registrada de DVD Format/Logo Licensing Corporation.

Los reproductores de DVD con  pueden reproducir DVD-RW grabados en modo VR.

- Los siguientes discos se recomiendan para obtener una buena calidad de grabación y han sido comprobados como compatibles con este aparato. Sin embargo, según sea la condición del medio el equipo podría no leer el disco correctamente.

Verbatim DVD-R 8x, DVD-RW 2x  
JVC DVD-RW 4x  
Maxell DVD-R 8x/16x

El comportamiento de cualquier otro disco no está garantizado.

## Códigos de Región

El número presente en el interior del globo se refiere a una región del mundo. Este aparato puede reproducir discos DVD que estén rotulados para ALL las regiones o para la región 1.



## Discos no Reproducibles

En este aparato no se podrán reproducir los siguientes discos.

- CD-ROM
- Disco compacto interactivo (CD-I)
- Disco simple de video (VSD)
- DVD-ROM
- Audio en DVD
- Disco sin finalizar
- El DVD contiene archivos MP3 o JPEG
- DVD-R grabado en formato VR o en formato de grabación no compatible

En el siguiente disco, es posible que no se escuche el sonido.

- Super audio CD - Sólo se podrá escuchar el sonido de la capa del CD. No se podrá escuchar el sonido de la capa de alta densidad de un super audio CD.

## Conexión Básica

- 1) Desconecte el cable de alimentación de su televisor del tomacorriente de CA.
- 2) Efectúe la conexión básica ilustrada más abajo.

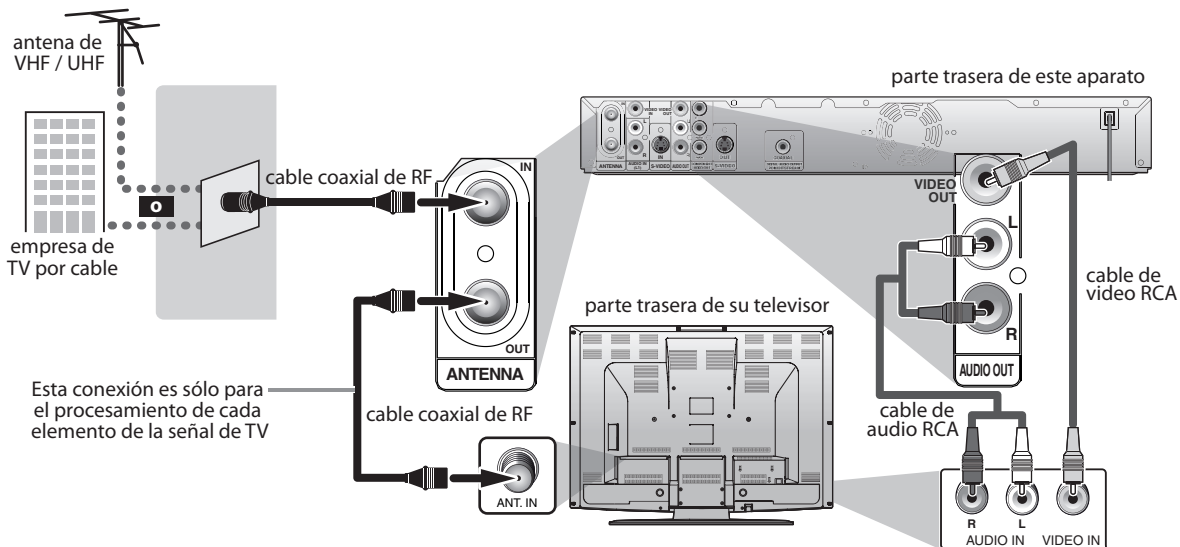

- 3) Enchufe los cables de alimentación de los aparatos al tomacorriente de CA.

## Conexión a Una Caja de TV por Cable / Satelital

- 1) Desconecte el cable de alimentación de su televisor del tomacorriente de CA.
- 2) Efectúe la conexión como se ilustra abajo.

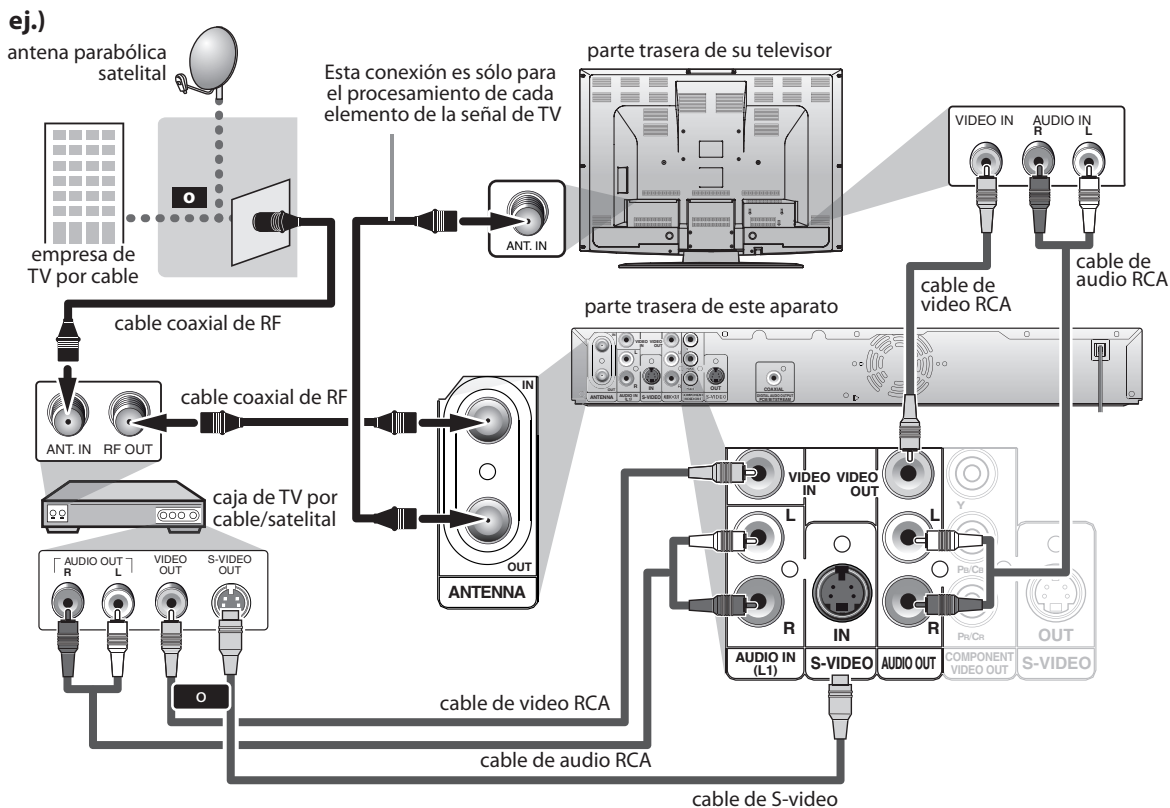

- 3) Enchufe los cables de alimentación de los aparatos al tomacorriente de CA.

## Configuración Inicial

Cuando usted encienda este aparato por primera vez necesita seguir estos pasos.

**1** Presione [POWER].  
Encienda el televisor. Seleccione la entrada a la cual está conectado el aparato.

**2** Utilice [▲ / ▼] para seleccionar su idioma deseado, y luego presione [ENTER] para establecerlo.

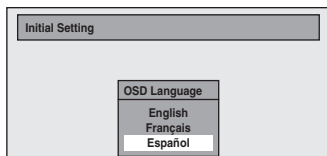

**3** Utilice [▲ / ▼] para seleccionar el tipo de señal de emisión, y luego presione [ENTER].

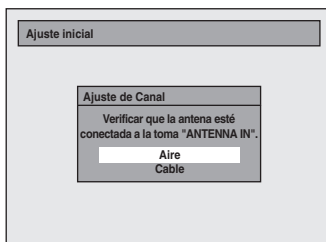

El equipo comenzará a obtener los canales disponibles en su región.

**4** Presione [ENTER] para activar "Ajuste Manual de Reloj".

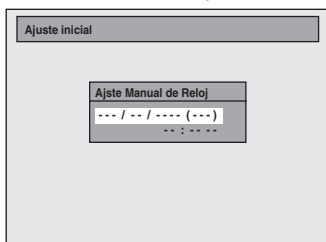

**5** Utilice [◀/▶] para seleccionar un elemento a configurar, y utilice [▲ / ▼] para seleccionar el contenido de su preferencia, y luego presione [ENTER].

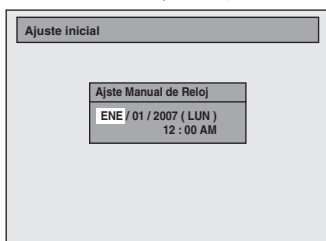

## Grabación Básica

**1** Presione [OPEN/CLOSE ▲] para abrir la bandeja de discos e insertar su disco con el rótulo apuntando hacia arriba.

\* Este aparato puede grabar a DVD-RW y DVD-R. El disco DVD-R pueden ser grabados sólo una vez. El disco DVD-RW pueden ser grabados y borrados muchas veces.



**2** Para seleccionar la velocidad de grabación presione [REC SPEED].



Modo de grabación	Tiempo de grabación		Calidad del video y el sonido
	Disco de 8 cm	Disco de 12 cm	
XP / 1H	18 min	60 min	Buena ↑ ↓ Deficiente
SP / 2H	36 min	120 min	
LP / 4H	72 min	240 min	
EP / 6H	108 min	360 min	
SLP / 8H	144 min	480 min	

**3** Presione [DTV/TV] para seleccionar TV analógica o TV digital, luego y utilice [CH ▲ / ▼] o [los botones numéricos] para seleccionar un canal que se desee grabar.



**4** Presione [REC/OTR] para iniciar la grabación.

**Para configurar la grabación a un toque con temporizador (OTR)...**

Esta es una manera sencilla de configurar el tiempo de grabación en bloques de 30 minutos. Presione [REC/OTR] repetidamente hasta que aparezca en la pantalla del televisor la longitud deseada de grabación (30 minutos a 8 horas).

Comenzará la grabación a un toque con temporizador.

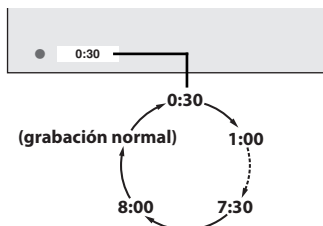

- Para cambiar la duración de la grabación durante la grabación a un toque con temporizador, presione [REC/OTR] repetidamente hasta que aparezca la duración deseada.
- Para cancelar la grabación a un toque con temporizador dentro del tiempo especificado, presione [STOP ■].

**5** Para de tener la grabación presione [STOP ■].

## Grabación con Temporizador

Usted puede programar el equipo para que grabe hasta 12 programas, con un mes de anticipación. También hay disponibles grabaciones de programas diarias o semanales.

### Antes de grabar, asegúrese de que

- Antes de establecer una programación del temporizador configure el reloj.
- Inserte un disco grabable con suficiente espacio libre.

**1** Presione [TIMER PROG.].

**2** Utilice [▲ / ▼] para seleccionar "Prog. nuevo", y luego presione [ENTER].

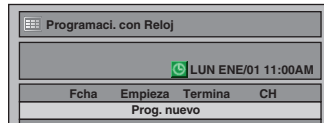

**3** Configure una programación del temporizador.

**4** Presione [ENTER].

**5** Presione [POWER] para configurar una programación del temporizador. Aparecerá en el pantalla del panel frontal.

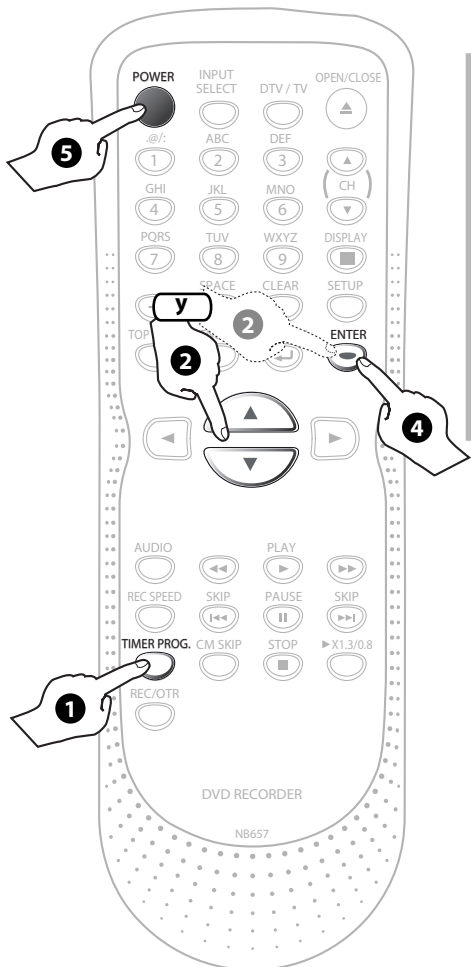

### Configure la fecha.

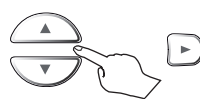

### Configure las horas de inicio y finalización.

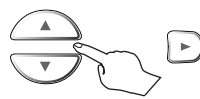

### Seleccione un modo deseado de entrada y el canal a grabar.

Para obtener más detalles, consulte "How to select a channel number for the timer recording" en la página 45 del manual del usuario.

ej.) modo digital

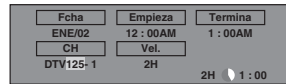

### Seleccione la velocidad de grabación.

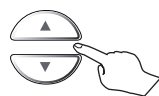
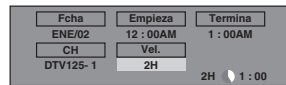

## Reproducción

**1** Abra la bandeja de discos.

OPEN/CLOSE

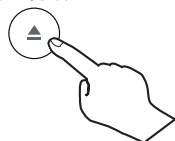

**2** Inserte un disco.

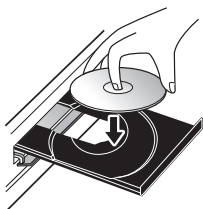

**3** Comience a reproducir.

PLAY



**4** Detenga la reproducción.

STOP

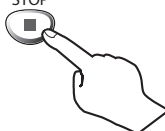

# **SYLVANIA**

## **LIMITED WARRANTY**

FUNAI CORP. will repair this product, free of charge in the USA in the event of defect in materials or workmanship as follows:

### **DURATION:**

**PARTS:** FUNAI CORP. will provide parts to replace defective parts without charge for one (1) year from the date of original retail purchase. Certain parts are excluded from this warranty.

**LABOR:** FUNAI CORP. will provide the labor without charge for a period of ninety (90) days from the date of original retail purchase.

### **LIMITS AND EXCLUSIONS:**

THIS WARRANTY IS EXTENDED ONLY TO THE ORIGINAL RETAIL PURCHASER. A PURCHASE RECEIPT OR OTHER PROOF OF ORIGINAL RETAIL PURCHASE WILL BE REQUIRED TOGETHER WITH THE PRODUCT TO OBTAIN SERVICE UNDER THIS WARRANTY.

This warranty shall not be extended to any other person or transferee.

This warranty is void and of no effect if any serial numbers on the product are altered, replaced, defaced, missing or if service was attempted by an unauthorized service center. This limited warranty does not apply to any product not purchased and used in the United States.

This warranty only covers failures due to defects in material or workmanship which occur during normal use. It does not cover damage which occurs in shipment, or failures which are caused by repairs, alterations or products not supplied by FUNAI CORP., or damage, which results from accident, misuse, abuse, mishandling, misapplication, alteration, faulty installation, improper maintenance, commercial use such as hotel, rental or office use of this product, or damage which results from fire, flood, lightning or other acts of God.

THIS WARRANTY DOES NOT COVER PACKING MATERIALS, ANY ACCESSORIES (EXCEPT REMOTE CONTROL), ANY COSMETIC PARTS, COMPLETE ASSEMBLY PARTS, DEMO OR FLOOR MODELS.

FUNAI CORP. AND ITS REPRESENTATIVES OR AGENTS SHALL IN NO EVENT BE LIABLE FOR ANY GENERAL, INDIRECT OR CONSEQUENTIAL DAMAGES ARISING OUT OF OR OCCASIONED BY THE USE OF OR THE INABILITY TO USE THIS PRODUCT. THIS WARRANTY IS MADE IN LIEU OF ALL OTHER WARRANTIES, EXPRESS OR IMPLIED, AND OF ALL OTHER LIABILITIES ON THE PART OF FUNAI, ALL OTHER WARRANTIES INCLUDING THE WARRANTY OF MERCHANTABILITY AND FITNESS FOR A PARTICULAR PURPOSE, ARE HEREBY DISCLAIMED BY FUNAI AND ITS REPRESENTATIVES IN THE UNITED STATES.

ALL WARRANTY INSPECTIONS AND REPAIRS MUST BE PERFORMED BY AN AUTHORIZED SERVICE CENTER.

THIS WARRANTY IS ONLY VALID WHEN THE UNIT IS CARRIED-IN TO AN AUTHORIZED SERVICE CENTER.

THE PRODUCT MUST BE ACCOMPANIED BY A COPY OF THE ORIGINAL RETAIL PURCHASE RECEIPT. IF NO PROOF OF PURCHASE IS ATTACHED, THE WARRANTY WILL NOT BE HONORED AND REPAIR COSTS WILL BE CHARGED.

### **IMPORTANT:**

THIS LIMITED WARRANTY GIVES YOU SPECIFIC LEGAL RIGHTS. YOU MAY HAVE OTHER RIGHTS THAT VARY FROM STATE TO STATE. IF, AT ANY TIME DURING THE WARRANTY PERIOD, YOU ARE UNABLE TO OBTAIN SATISFACTION WITH THE REPAIR OF THIS PRODUCT, PLEASE CONTACT FUNAI CORP.

### **ATTENTION:**

FUNAI CORP. RESERVES THE RIGHT TO MODIFY ANY DESIGN OF THIS PRODUCT WITHOUT PRIOR NOTICE.

### **WARRANTY STATEMENT REGARDING NON AUTHORIZED REPAIRS:**

To obtain warranty service, you must take the product, or deliver the product freight prepaid, in either its original packaging or packaging affording an equal degree of protection, to any AUTHORIZED SERVICE CENTER. FUNAI CORP. will not reimburse you for any service done by unauthorized service providers without prior written approval.

**To locate your nearest AUTHORIZED SERVICE CENTER or for general service inquiries, please contact us at:**

**FUNAI CORPORATION**

**Customer Service**

**Tel: 1-800-968-3429**

**<http://www.SylvaniaConsumerElectronics.com>**

19900 Van Ness Avenue, Torrance, CA 90501