

SYLVANIA

Blu-ray Disc / DVD Player

Owner's Manual

NB620SL1

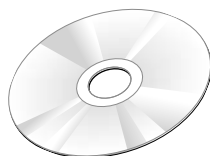
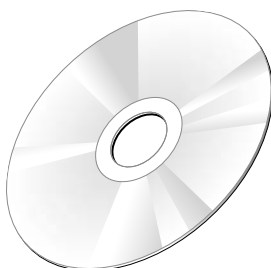

INTRODUCTION

Safety Instructions

The model and serial numbers of this unit may be found on the cabinet.	Model No.:
You should record and retain those numbers for future reference.	Serial No.:

WARNING:

TO REDUCE THE RISK OF FIRE OR ELECTRIC SHOCK, DO NOT EXPOSE THIS APPARATUS TO RAIN OR MOISTURE. APPARATUS SHALL NOT BE EXPOSED TO DRIPPING OR SPLASHING AND NO OBJECTS FILLED WITH LIQUIDS, SUCH AS VASES, SHALL BE PLACED ON THE APPARATUS.



CAUTION:

TO REDUCE THE RISK OF ELECTRIC SHOCK, DO NOT REMOVE COVER (OR BACK). NO USER SERVICEABLE PARTS INSIDE. REFER SERVICING TO QUALIFIED SERVICE PERSONNEL.

The important note is located on the rear or bottom of the cabinet.

	The lightning flash with arrowhead symbol, within an equilateral triangle, is intended to alert the user to the presence of uninsulated "dangerous voltage" within the product's enclosure that may be of sufficient magnitude to constitute a risk of electric shock to persons.
--	---

	The exclamation point within an equilateral triangle is intended to alert the user to the presence of important operating and maintenance (servicing) instructions in the literature accompanying the appliance.
--	--

 The symbol for CLASS II (Double Insulation)

IMPORTANT SAFETY INSTRUCTIONS

1. Read these instructions.
2. Keep these instructions.
3. Heed all warnings.
4. Follow all instructions.
5. Do not use this apparatus near water.
6. Clean only with dry cloth.
7. Do not block any ventilation openings. Install in accordance with the manufacturer's instructions.
8. Do not install near any heat sources such as radiators, heat registers, stoves, or other apparatus (including amplifiers) that produce heat.
9. Do not defeat the safety purpose of the polarized or grounding-type plug. A polarized plug has two blades with one wider than the other. A grounding type plug has two blades and a third grounding prong. The wide blade or the third prong are provided for your safety. If the provided plug does not fit into your outlet, consult an electrician for replacement of the obsolete outlet.
10. Protect the power cord from being walked on or pinched particularly at plugs, convenience receptacles, and the point where they exit from the apparatus.
11. Only use attachments/accessories specified by the manufacturer.
12. Use only with the cart, stand, tripod, bracket, or table specified by the manufacturer, or sold with the apparatus. When a cart is used, use caution when moving the cart/apparatus combination to avoid injury from tip-over. 
13. Unplug this apparatus during lightning storms or when unused for long periods of time.
14. Refer all servicing to qualified service personnel. Servicing is required when the apparatus has been damaged in any way, such as power-supply cord or plug is damaged, liquid has been spilled or objects have fallen into the apparatus, the apparatus has been exposed to rain or moisture, does not operate normally, or has been dropped.

FCC WARNING

This equipment may generate or use radio frequency energy. Changes or modifications to this equipment may cause harmful interference unless the modifications are expressly approved in the manual. The user could lose the authority to operate this equipment if an unauthorized change or modification is made.

RADIO-TV INTERFERENCE

This equipment has been tested and found to comply with the limits for a Class B digital device, pursuant to Part 15 of the FCC Rules. These limits are designed to provide reasonable protection against harmful interference in a residential installation. This equipment generates, uses, and can radiate radio frequency energy and, if not installed and used in accordance with the instructions, may cause harmful interference to radio communications. However, there is no guarantee that interference will not occur in a particular installation. If this equipment does cause harmful interference to radio or television reception, which can be determined by turning the equipment off and on, the user is encouraged to try to correct the interference by one or more of the following measures:

- 1) Reorient or relocate the receiving antenna.
- 2) Increase the separation between the equipment and receiver.
- 3) Connect the equipment into an outlet on a circuit different from that to which the receiver is connected.
- 4) Consult the dealer or an experienced radio/TV technician for help.

This Class B digital apparatus complies with Canadian ICES-003.

Cet appareil numérique de la classe B est conforme à la norme NMB-003 du Canada.

Disconnect the mains plug to shut off when find trouble or not in use. The mains plug shall remain readily operable.

- CAUTION:** Danger of explosion if battery is incorrectly replaced. Replace only with the same or equivalent type.
- WARNING:** Batteries (Battery pack or battery installed) shall not be exposed to excessive heat such as sunshine, fire, or the like.

LASER SAFETY

This apparatus employs a laser. Only a qualified service person should remove the cover or attempt to service this apparatus, due to possible eye injury.

- CAUTION:** Use of controls or adjustments or performance of procedures other than those specified herein may result in hazardous radiation exposure.
- CAUTION:** Laser radiation when open. Do not stare into beam.
- LOCATION:** Inside, near the BD mechanism.

IMPORTANT COPYRIGHT INFORMATION

Unauthorized copying, broadcasting, public performance and lending of discs are prohibited. This item incorporates copy protection technology that is protected by U.S. patents and other intellectual property rights of Rovi Corporation. Reverse engineering and disassembly are prohibited.

Do not place the unit on the furniture that is capable of being tilted by a child and an adult leaning, pulling, standing or climbing on it. A falling unit can cause serious injury or even death.

This apparatus should not be placed in a built-in installation such as a bookcase or rack unless proper ventilation is provided. Make sure to leave a space of 3.9 inches (10cm) or more around this apparatus.

To Avoid the Hazards of Electrical Shock and Fire

- Do not handle the AC power cord with wet hands.
- Do not pull on the AC power cord when disconnecting it from an AC outlet. Grasp it by the plug.
- Do not put your fingers or objects into the unit.

Location and Handling

- Do not install the unit in direct sunlight, near strong magnetic fields, or in a place subject to dust or strong vibration.
- Avoid a place with drastic temperature changes.
- Install the unit in a horizontal and stable position. Do not place anything directly on top or bottom of the unit. Depending on your external devices, noise or disturbance of the picture and/or sound may be generated if the unit is placed too close to them. In this case, please ensure enough space between the external devices and the unit.
- Depending on the environment, the temperature of this unit may increase slightly. This is not a malfunction.
- Be sure to remove the disc and unplug the AC power cord from the outlet before carrying the unit.

Dew Condensation Warning

- Dew condensation may form inside the unit in the following conditions. If so, do not use this unit at least for a few hours until its inside gets dry.
 - The unit is moved from a cold place to a warm place.
 - Under conditions of high humidity.
 - After heating a cold room.

Note about Recycling

- This unit's packaging materials are recyclable and can be reused. Please dispose of any materials in accordance with your local recycling regulations.
- Batteries should never be thrown away or incinerated but disposed of in accordance with your local regulations concerning chemical wastes.



Notice for Progressive Scan Output

- Consumers should note that not all high definition television sets are fully compatible with this product and may cause artifacts to be displayed in the picture. In case of picture problems with 480 progressive scan output, it is recommended that the user switch the connection to the 'standard definition' output. If there are questions regarding your TV set compatibility with this 480p BD/DVD player, please contact our customer service center.



ENERGY STAR® is a joint program of the U.S. Environmental Protection Agency and the U.S. Department of Energy helping us all save money and protect the environment through energy efficient products and practices.

Supplied Accessories

- Remote Control (NB905UD/NB955UD)
- Batteries (AAA, 1.5V × 2)
- Audio / video cables
- Quick Start Guide
- Wireless Network Connection Guide
- VUDU sheet
- Netflix Box-insert

© 2010 Funai Electric Co., Ltd.

All rights reserved. No part of this manual may be reproduced, copied, transmitted, disseminated, transcribed, downloaded or stored in any storage medium, in any form or for any purpose without the express prior written consent of Funai. Furthermore, any unauthorized commercial distribution of this manual or any revision hereto is strictly prohibited.

Information in this document is subject to change without notice. Funai reserves the right to change the content herein without the obligation to notify any person or organization of such changes.

FUNAI with the  design is a registered trademark of Funai Electric Co., Ltd. and may not be used in any way without the express written consent of Funai. All other trademarks used herein remain the exclusive property of their respective owners. Nothing contained in this manual should be construed as granting, by implication or otherwise, any license or right to use any of the trademarks displayed herein. Misuse of any trademarks or any other content in this manual is strictly prohibited. Funai shall aggressively enforce its intellectual property rights to the fullest extent of the law.

SYLVANIA is a registered trademark of OSRAM SYLVANIA Inc., used under license.

CONTENTS

INTRODUCTION.....	2
Safety Instructions.....	2
Supplied Accessories.....	4
Trademark Information.....	6
Front Panel.....	7
Rear Panel.....	7
Remote Control.....	8
Installing the Batteries in the Remote Control.....	9
Opening Screen.....	9
CONNECTIONS.....	10
Connection to the TV.....	10
Connection to an Audio System.....	11
2-Channel Analog Audio Connection.....	11
Digital Audio Connection.....	11
HDMI Audio Connection.....	11
Connection to the Network.....	12
Wired Connection.....	12
Wireless Connection.....	13
Finding the Video Channel on Your TV.....	13
PLAYBACK.....	14
Information on Playback.....	14
Playable Discs and Files.....	14
Unplayable Discs and Files.....	14
Region Codes.....	15
On-Screen Display.....	15
How to Insert a Disc.....	15
Reading the SD Memory Card.....	16
Selecting the Media Mode.....	16
Playing Back (BD / DVD/ Disc with AVCHD Files).....	16
Using the Title / Disc / Pop-up Menu.....	17
Playing Back (Audio CD / Windows Media™ Audio / JPEG Files).....	17
KODAK Picture CD.....	18
Fast Forward / Fast Reverse.....	19
Slow Forward Playback.....	19
Step by Step Playback.....	19
Repeat Playback.....	19
Program Playback.....	19
Random Playback.....	20
Rapid Playback.....	21
Adjusting the Picture.....	21
Virtual Surround.....	21
PIP (BONUSVIEW) Setting.....	22
Camera Angle.....	22
Enjoying BD-Live Discs with Internet.....	22
Search.....	23
Using [the Number buttons] (Direct Search).....	23
Switching Subtitles.....	23
Switching Audio Soundtrack.....	24
Setting the BD Audio Mode.....	24
NETWORK OPERATIONS.....	25
Netflix Operations.....	25
Before Activating the Connection to Netflix.....	25
Activating the Connection to Netflix.....	25
Watching Streaming Movies.....	25
CinemaNow / Blockbuster Operations.....	26
Before Activating the Connection to CinemaNow / Blockbuster.....	26
Activating the Connection to CinemaNow / Blockbuster.....	26
Guide to CinemaNow / Blockbuster Menu Screen.....	26
Renting or Purchasing Movies / TV Episodes.....	27
Searching Movies / TV Episodes.....	27
Watching Rented or Purchased Movies / TV Episodes.....	27
VUDU Operations.....	27
Before Activating VUDU.....	27
Activating VUDU.....	28
Guide to VUDU Menu Screen.....	28
Renting or Purchasing VUDU Movies / TV Episodes.....	28
Watching Rented or Purchased VUDU Movies / TV Episodes.....	29
Using Internet Applications.....	29
FUNCTION SETUP.....	29
Quick.....	29
Custom.....	30
Language.....	30
Video.....	30
Audio.....	31
HDMI Audio Out Setting.....	32
Digital Out Setting.....	32
Speaker Setting (Available when you have HDMI cable connected to HDMI OUT jack).....	33
Parental.....	35
Others.....	36
fun-Link (HDMI CEC).....	38
Network Connection.....	39
Connection Test.....	39
Network Selection.....	39
Software Update.....	43
Current Version.....	43
Initialize.....	44
OTHERS.....	45
Troubleshooting.....	45
Language Code List.....	48
Servicing.....	48
Specifications.....	49
NETWORK SERVICE DISCLAIMER.....	49
Network Service Disclaimer.....	49
ESPAÑOL.....	50
Discos Reproducibles.....	50
Discos y Archivos Reproducibles.....	50
Códigos de Región.....	50
Encontrar el Canal de Vídeo en su Televisor.....	50
Ajusta el idioma para el menú del reproductor.....	50
Reproducción Directa.....	51
LIMITED WARRANTY.....	back cover

Trademark Information



HDMI, the HDMI Logo, and High-Definition Multimedia Interface are trademarks or registered trademarks of HDMI Licensing LLC in the United States and other countries.



Manufactured under license from Dolby Laboratories. Dolby and the double-D symbol are trademarks of Dolby Laboratories.



Manufactured under license under U.S. Patent #'s: 5,451,942; 5,956,674; 5,974,380; 5,978,762; 6,487,535 & other U.S. and worldwide patents issued & pending. DTS and the Symbol are registered trademarks, & DTS-HD, DTS-HD Advanced Digital Out and the DTS logos are trademarks of DTS, Inc. Product includes software. © DTS, Inc. All Rights Reserved.



Java and all Java based trademarks and logos are trademarks or registered trademarks of Oracle and/or its affiliates.



Windows Media and the Windows logo are trademarks or registered trademarks of Microsoft Corporation in the United States and/or other countries.



"AVCHD" and the "AVCHD" logo are trademarks of Panasonic Corporation and Sony Corporation.



"BONUSVIEW" is trademark of Blu-ray Disc Association.



"BD-Live" and "BD-Live" logo are trademarks of Blu-ray Disc Association.



VUDU™ is a trademark of VUDU, Inc.



Netflix and the Netflix logo are trademarks or registered trademarks of Netflix, Inc.



BLOCKBUSTER name, design and related marks are trademarks of Blockbuster Inc.



© 2010 Sonic Solutions. Roxio, CinemaNow, Roxio CinemaNow and the Roxio CinemaNow logos are trademarks or registered trademarks owned by Sonic Solutions in the United States and other jurisdictions.

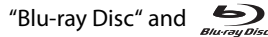

"Blu-ray Disc" and  are trademarks.



 is a trademark of DVD Format/Logo Licensing Corporation.



Kodak and KODAK Picture CD Compatible are trademarks of Kodak used under license.

Front Panel

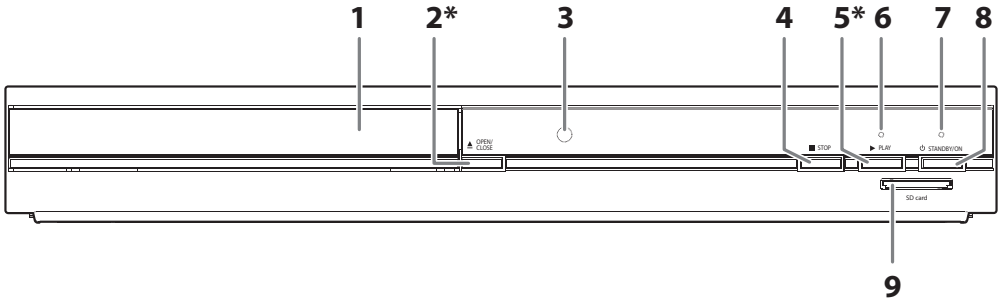

(*) The unit can also be turned on by pressing these buttons.

- 1. Disc tray**
- 2. ▲ OPEN/CLOSE button***
- 3. Infrared sensor window**
- 4. ■ STOP button**
- 5. ► PLAY button***
- 6. PLAY indicator**
 - This indicator lights up in green when discs or SD cards play back.
- 7. STANDBY/ON indicator**
 - This indicator lights up in red when the power is in the standby mode.

- 8. ⏻ STANDBY/ON button**
 - Press to turn on the unit, or to turn the unit into the standby mode. (To completely turn off the unit, you must unplug the AC power cord.)
 - Press and hold for 10 seconds to shut down the unit.
- 9. SD card slot**

Note

- This unit will be turned into the standby mode automatically after 25 minutes of no action.

Rear Panel

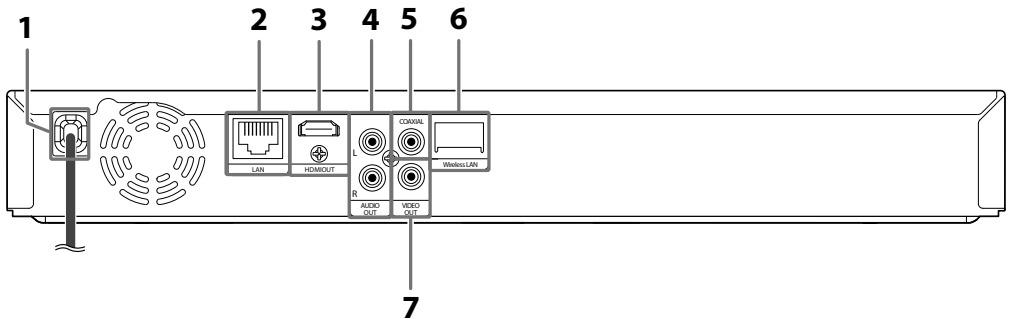

- 1. AC power cord**
- 2. LAN terminal**
- 3. HDMI OUT jack**
- 4. AUDIO OUT jacks**
- 5. DIGITAL OUT (COAXIAL) jack**
- 6. Wireless LAN**
- 7. VIDEO OUT jack**

Note

- Do not touch the inner pins of the jacks on the rear panel. Electrostatic discharge may cause permanent damage to the unit.
- This unit does not have the RF modulator.
- Do not try to rip the internal wireless LAN from the unit.

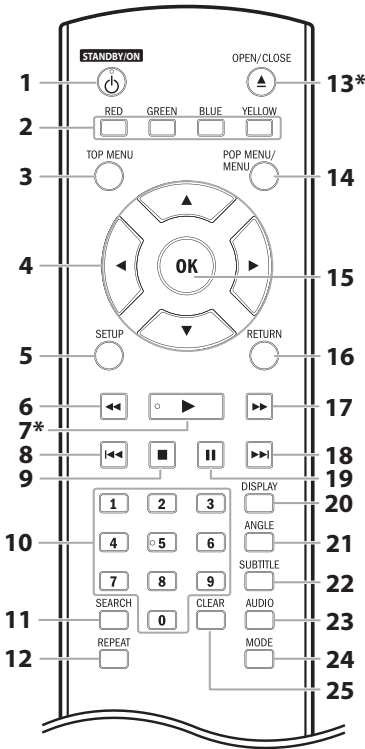

(*) The unit can also be turned on by pressing these buttons.

1. STANDBY/ON button

- Press to turn on the unit, or to turn the unit into the standby mode. (To completely turn off the unit, you must unplug the AC power cord.)

2. RED / GREEN / BLUE / YELLOW button

- Press to select items on some BD menus.
- When file list / thumbnail list is shown, press to switch between pages.

3. TOP MENU button

- Press to display the top menu.
- During Netflix / CinemaNow / Blockbuster / VUDU feature screen is displayed (except during playback), press to exit.

4. / / / buttons

- Press to select items or settings.

5. SETUP button

- Press to display or to exit the setup menu.

6. (reverse) button

- During playback, press to fast reverse the playback.

7. (play) button*

- Press to start playback or resume playback.

8. (skip) button

- During playback, press once to return to the beginning of the current title, chapter or track.
- During playback, press twice to return to the previous title, chapter or track.
- During the JPEG playback, press to return to the previous file.

9. (stop) button

- Press to stop playback.

10. Number buttons

- Press to enter the title, chapter, track or file number.
- Press to enter values in the input field.

11. SEARCH button

- Press to display the search menu.

12. REPEAT button

- Press to toggle between various repeat modes.

13. OPEN/CLOSE button*

- Press to open or close the disc tray.

14. POP MENU / MENU button

- Press to display the pop-up menu / disc menu.

15. OK button

- Press to confirm or select menu items.

16. RETURN button

- Press to return to the previously displayed menu screen.

17. (forward) button

- During playback, press to fast forward the playback.
- In pause mode, press to slow forward the playback.

18. (skip) button

- During playback, press to skip to the next title, chapter, track or file.

19. (pause) button

- Press to pause playback.
- When playback is in pause mode, press repeatedly to forward the playback step by step.

20. DISPLAY button

- Press to display the on-screen display menu.

21. ANGLE button

- Press to access various camera angles on the disc.
- Press to rotate the JPEG files clockwise by 90 degrees.

22. SUBTITLE button

- Press to display the subtitle menu.

23. AUDIO button

- Press to display the audio menu.

24. MODE button

- During BD or DVD or AVCHD files playback, press to display the setting for the rapid playback and the picture adjustment.
- During BD, DVD and CD playback, press to display the setting for the virtual surround.
- During BD playback, press to turn the picture-in-picture feature on or off (only applicable to BD-video which supports the PIP function).
- During the JPEG playback, press to display menus for changing the visual effect for switching the image or changing the size of the image.
- In stop mode with audio CD or WMA / JPEG files inserted, press to display menus for program and random playback.
- In stop mode with BD inserted, press to display a menu for setting the BD audio mode.

25. CLEAR button

- Press to clear the information once entered or to cancel the programming for audio CD, etc.

Installing the Batteries in the Remote Control

Install AAA (1.5V) battery × 2 matching the polarity indicated inside battery compartment of the remote control.

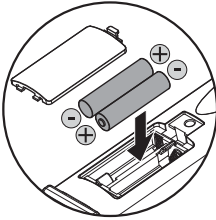

Note

Incorrect use of batteries can result in hazards such as leakage and bursting. Please observe the following:

- Do not mix alkaline, standard (carbon-zinc), or rechargeable (ni-cad, ni-mh, etc) batteries.
- Do not mix new and old batteries together.
- Do not use different kinds of batteries together. Although they may look similar, different batteries may have different voltages.
- Make sure that the + and - ends of each battery match the indications in the battery compartment.
- Remove batteries from battery compartment that are not going to be used for a month or more.
- When disposing of used batteries, please comply with governmental regulations or environmental public rules that apply in your country or area.
- Do not recharge, short-circuit, heat, burn or disassemble batteries.

Opening Screen

In stop mode, opening screen is displayed.

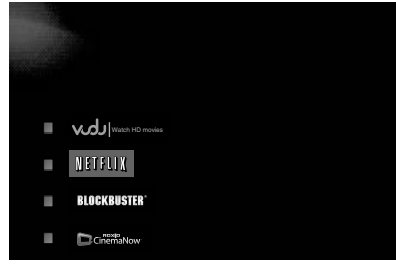

"VUDU":	To access the VUDU App Home screen
"NETFLIX":	To access the Netflix screen
"BLOCKBUSTER":	To access the Blockbuster menu screen
"CinemaNow"	To access the CinemaNow menu screen

CONNECTIONS

Connection to the TV

HDMI Video / Audio Connection (Supports up to 1080i / 1080p, 1080p24 resolution.)

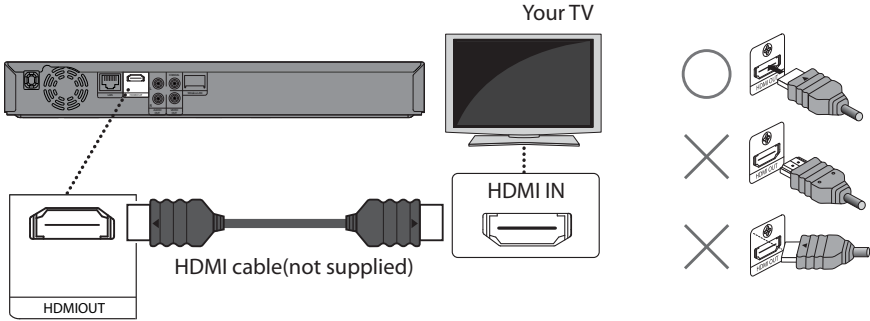

- No analog audio connection required.
- Use an HDMI cable with the HDMI logo (a certified HDMI cable) for this connection.
- High Speed HDMI cable (also known as HDMI category 2 cable) is recommended for optimal compatibility.

Picture is not displayed on the TV screen ...

The indicators blink under the following conditions.

- When the connected device does not support HDCP.
- When the connected device is recognized as an HDCP incompatible by HDMI SRM.
- When the connected device supports HDCP but cannot be recognized as an HDCP compatible for some reason.

The indicators blink as follows for 30 seconds.

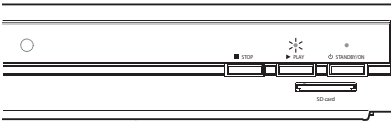

Standard Video + Standard Audio Connection (Supports only 480i resolution.)

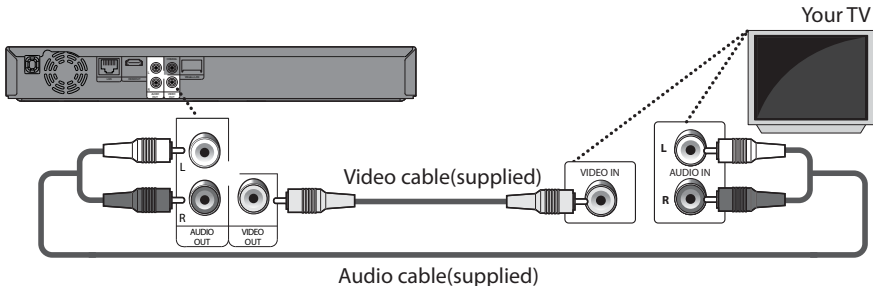

- Connect this unit directly to the TV. If the audio / video cables are connected to a VCR, pictures may be distorted due to the copy right protection system.

Connection to an Audio System

- When you change the connections, all devices should be turned off.
- Refer to the manual accompanying external devices for more information.

2-Channel Analog Audio Connection

stereo system

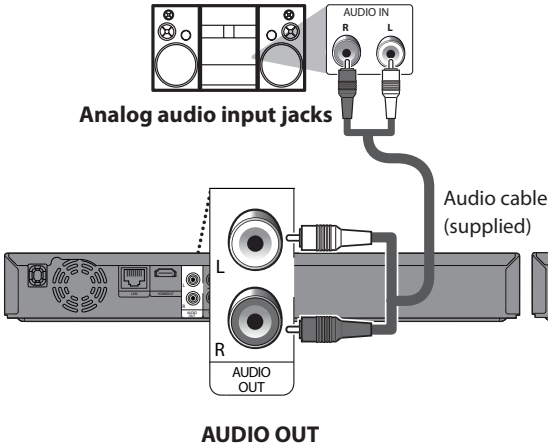

Digital Audio Connection

AV receiver/amplifier

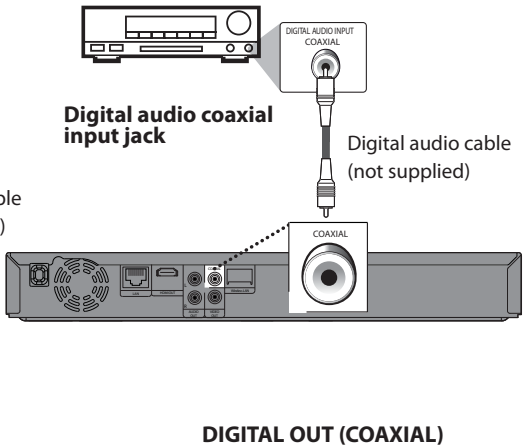

To set up "Digital Out", refer to page 32.

HDMI Audio Connection

AV receiver/amplifier with an HDMI input jack

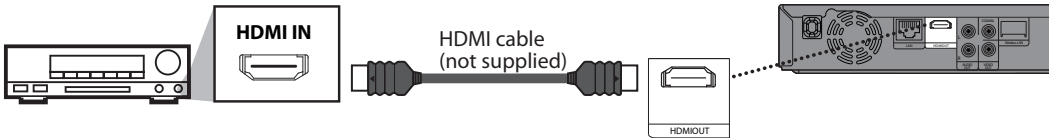

To set up "HDMI Audio Out", refer to page 31.

Connection to the Network

By connecting this unit to the Internet, you can access Netflix / CinemaNow / Blockbuster / VUDU services and applications, BD-Live features on a Blu-ray Disc and perform network update.

- For more information about software update, refer to "Network Update" on page 44.
- For more information about BD-Live, refer to "Enjoying BD-Live Discs with Internet" on page 22.
- For more information about Netflix, refer to "Netflix Operations" on page 25.
- For more information about CinemaNow / Blockbuster, refer to "CinemaNow / Blockbuster Operations" on page 26.
- For more information about VUDU, refer to "VUDU Operations" on page 27.

Note

- Wired connection is recommended when using following features. (Using following features with wireless connection can be affected by other devices using radio frequencies.)
 - Video streaming services (Netflix / CinemaNow / Blockbuster / VUDU)
 - Network update

Wired Connection

Make the following connection if you are using a wired router.

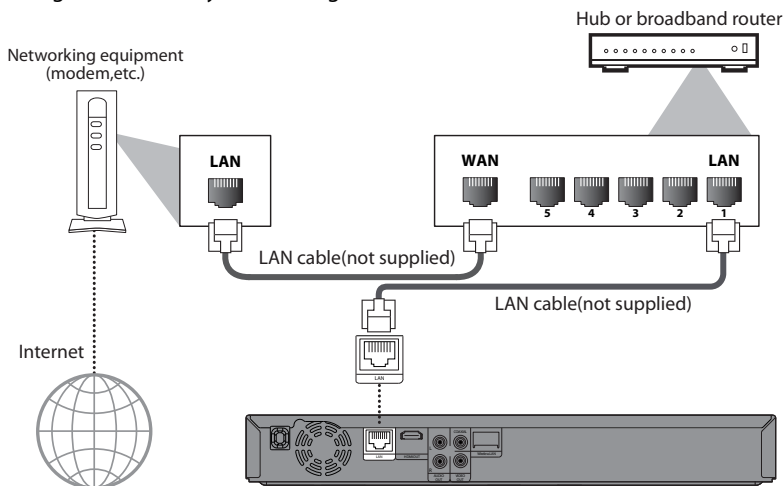

Note

- After you made a wired connection, set up necessary network settings. (For network setting of wired connection, refer to "Wired" on page 39.)
- Do not insert any cable other than a LAN cable to the LAN terminal to avoid damaging the unit.
- If your network equipment (modem, etc.) does not have broadband router functions, connect a wired broadband router.
- If your network equipment (modem, etc.) has broadband router functions but there is no vacant port, use a hub.
- For a wired broadband router, use a router which supports 10BASE-T/100BASE-TX.
- Do not connect your PC directly to the LAN terminal of this unit.
- Please purchase shielded LAN cables at your local store and use them when you connect to network equipment.

Wireless Connection

Make the following connection if you are using a wireless router.

Networking equipment
(modem, etc.)

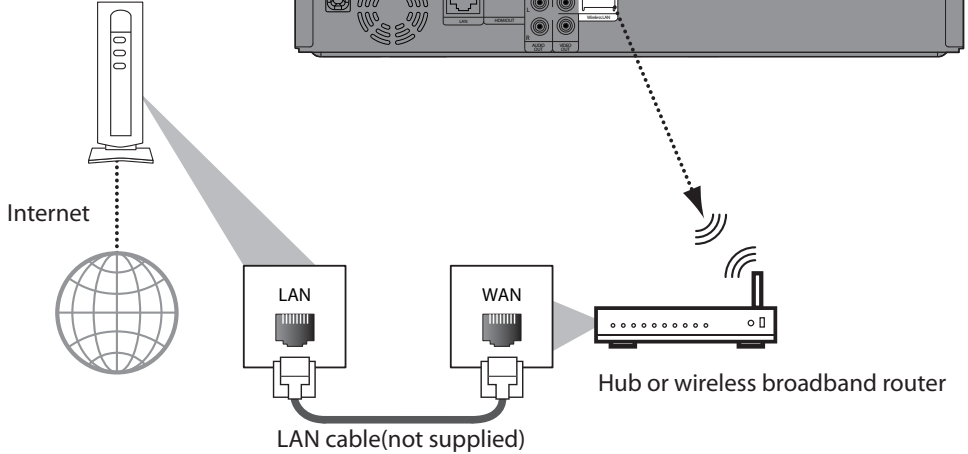

Note

- After you made the wireless connection, set up necessary network settings.
(For network setting of wireless connection, refer to "Wireless" on page 41.)
- For a wireless router, use a router which supports IEEE 802.11 b/g/n.
(n is recommended for stable operation of the wireless network.)
- Set the wireless router to Infrastructure mode. This unit does not support Ad-hoc mode.
- Other radio devices or obstacles may cause interference to the wireless network connection.

Finding the Video Channel on Your TV

After you have completed all the connections, you must find the correct video channel (external input channel) on your TV.

- 1 After you have made all the necessary connections, press [STANDBY/ON ] to turn on the unit.**
- 2 Turn on your TV.**
- 3 Press the button on the TV's remote control that accesses the external input channel. It may be labeled "SOURCE", "AV" or "SELECT" (refer to your TV's user manual).**



Note

- If the TV is connected by an HDMI cable, it may take a while for the opening picture to come up.

PLAYBACK

Information on Playback

Before you start playing back a disc, read the following information.

Playable Discs and Files

Playable discs
Blu-ray Disc
- BD-video (single / dual layer)
- BD-RE ver. 2.1 (single / dual layer) (Recorded in BDMV format)
- BD-R ver. 1.1 / 1.2 / 1.3 (single / dual layer) (Recorded in BDMV format) (Unclosed discs may not be played back.)
DVD-video
DVD-RW
DVD-R
CD-DA (audio CD)
CD-RW
CD-R
KODAK Picture CD
DTS-CD

Playable files	Media
AVCHD	DVD-RW/-R SD Memory Card (including SDHC) miniSD Card microSD Card
Windows Media™ Audio	BD-RW/-R DVD-RW/-R CD-RW/-R
JPEG	SD Memory Card (including SDHC) miniSD Card microSD Card

Readable cards	Playable files / data
SD Memory Card (8 MB - 2 GB)	AVCHD, Windows Media™ Audio, JPEG, picture-in-picture commentary, subtitles or other extras for BD-ROM ver. 2 (Profile 2.0 / Profile 1.1)
SDHC Memory Card (4 GB - 8 GB)	
miniSD Card (8 MB - 2 GB)	
microSD Card (8 MB - 2 GB)	

Note for SD Memory Cards

- This unit supports SD Memory Card with FAT12/ FAT16 file system, and SDHC Memory Card with FAT32 file system.
- This unit does not support NTFS file system.
- This unit may not read SD Memory Cards formatted on a computer. If that is the case, please reformat the SD Memory Cards in this unit and try again.

- This unit does not support miniSDHC and microSDHC Memory Card.
- For miniSD Card and microSD Card, an adapter is necessary.
- Portions of this product are protected under copyright law and are provided under license by ARIS / SOLANA / 4C.
- Please keep the SD Memory Cards in their cases when you are not using them.
- Do not try to open or modify the card.
- Do not touch the terminal surface with your fingers or any metals.
- Do not attach additional labels or stickers to cards.
- Do not remove the label of the SD Memory Cards.
- This unit recognizes up to 8 characters of file name in the SD Memory Card. Characters after 8th will not be displayed.

Unplayable Discs and Files

- CD-ROM
- CD-I (compact disc-interactive)
- DVD-RAM
- VSD (video single disc)
- DVD-audio
- Video CD
- HD DVD
- SVCD
- Unfinalized disc
- BD-RE (ver.1.0)
- BD-RE (ver.2.1) (Recorded in BDAV format)
- BD-R (ver.1.1 / 1.2 / 1.3) (Recorded in BDAV format)
- BD that contains AVCHD files
- BD / DVD / CD / SD Memory Card contains MP3, and DivX® files
- BD/DVD hybrid disc (played back as a BD-video only)
- DVD-RW/-R recorded in non compatible recording format
- Super Audio CD - Only the sound on the CD layer can be heard. The sound on the high-density Super Audio CD layer cannot be heard.
- Playability of dual discs are not guaranteed.
- This unit cannot play back the disc contents protected by Windows Media™ Digital Rights Management (DRM).

Region Codes

This unit has been designed to play back BD-video with region "A" and DVD-video with region "1" or "ALL". You cannot play back BD-video or DVD-video that are labeled for other regions. Look for the symbols on your BD-video or DVD-video. If these region symbols do not appear on your BD-video or DVD-video, you cannot play back the disc in this unit. The letter or number inside the globe refers to region of the world. A BD-video or DVD-video labeled for a specific region can only be played back in the unit with the same region code.

On-Screen Display

You can check information about the current disc by pressing [DISPLAY].

To call the on-screen display menu, press [DISPLAY] during playback. Every time you press [DISPLAY], the information changes. Depending on the media, available information varies.

■ Chapter information

<Title / Chapter information for BD and AVCHD>



<Chapter information for DVD>



1. Current title number
2. Current chapter number / Total number of chapters
3. Current repeat setting (Only when repeat setting is active)
(C: Chapter repeat, T: Title repeat)
4. Indicates that the multi camera angle images are available on the scene
5. Current playback status
6. Elapsed time (or remaining time) of the current chapter

■ Title information



1. Current title number / Total number of titles
2. Elapsed time (or remaining time) of the current title

■ Track / File information



1. Current track (file) number / Total number of track(file)
2. Elapsed time (or remaining time) of the current track (except for JPEG files)
3. Indication of SD Memory Card playback
4. Current repeat setting
(Only when repeat setting is active)
(T: Track repeat, G: Group repeat, A: All repeat)

■ Disc information



1. Current track number / Total number of tracks
2. Elapsed time (or remaining time) of the current disc

■ File name information



1. Media icon and file name

WMA files

JPEG file

■ Tag information

<Title name information>



<Artist name information>



1. Title name based on tag information of current Windows Media™ Audio file
2. Artist name based on tag information of current Windows Media™ Audio file

■ Decoding format information



1. Decoding format

How to Insert a Disc

1. Press [OPEN/CLOSE ▲] to open the disc tray.
2. Place the disc on the disc tray with its label side facing up.



Align the disc to the disc tray guide.

- Make sure the disc is compatible with this unit. (Refer to page 14 for the list of compatible discs.)
3. Press [OPEN/CLOSE ▲] to close the disc tray. It may take a while to load the disc.

To eject the disc:

Press [OPEN/CLOSE ▲] to open the disc tray.
Remove the disc.
Press [OPEN/CLOSE ▲] to close the disc tray.

Reading the SD Memory Card

You can play back the AVCHD / WMA / JPEG files in an SD Memory Card.

With the SD Memory Card, you can also enjoy the following functions.

- Special additional contents for BD-ROM Profile 1 ver.1.1. (For more information about the special additional contents, refer to the instruction book that came with the disc.)
- BD-Live function (BD-ROM ver. 2 Profile 2.0). (For more information about BD-Live, refer to page 22.)

1. Insert an SD Memory Card, with the label side facing up, into the SD card slot until it clicks.

- If no disc is in operation, "Media Select" screen will appear on the TV screen.

2. Use [▲/▼] to select "SD Card", then press [OK].

3. Use [▲/▼] to select a desired track, folder or file, then press [OK]. Use [◀/▶] to go backward and forward between the hierarchies.

- If you press [OK] on the desired file, playback will start.

To remove the SD Memory Card:

In stop mode, gently push in the SD Memory Card, then pull it out slowly.

Note

- The "Media Select" screen will disappear under the conditions listed below:
 - when the screen saver is activated.
 - when [RETURN] is pressed.
 - when the setup menu is called up.
- If the "Media Select" screen disappears before you make the selection, refer to "Selecting the Media Mode" on page 16.
- Do not remove the SD Memory Card or turn the unit to the standby mode while the contents of the card are in playback. It may result in malfunction or loss of the card's data.
- Do not delete the folders or files in the SD Memory Card with your computer. This unit may not read SD Memory Cards formatted on a computer.
- If a folder or file name includes one of the following unrecognizable characters, the folder or file name may not be displayed correctly.
 - Unrecognizable characters : . , " = + [] ; / \ : | ¥
- For an SD Memory Card, extension other than listed below cannot be recognized.
 - WMA : ".wma"
 - JPEG : ".jpg"

Selecting the Media Mode

For the playback media to be read by this unit, the correct media mode should be selected. You can switch the media mode by following the steps below.

1. In stop mode, press [SETUP].

2. Use [▲/▼] to select \mathcal{B} , then press [OK].

3. Use [▲/▼] to select "Mode Select"; then press [OK].

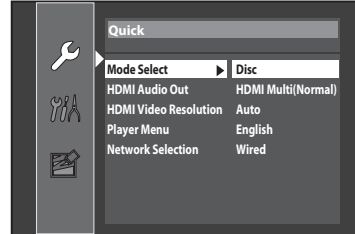

4. Use [▲/▼] to select the desired media mode, then press [OK].

5. Press [SETUP] to exit.

- Selected media mode is now activated.

Even if you turn the unit to the standby mode in "SD Card" or "Network" mode, it will be in "Disc" mode the next time you turn it on.

Playing Back (BD / DVD/ Disc with AVCHD Files)

1. Press [STANDBY/ON] .

2. Turn on the TV and select the appropriate input on the TV to which the unit is connected.

3. Insert a disc (refer to "How to Insert a Disc" on page 15).

4. Playback may start automatically.

If not, press [▶] (play).

- Some discs may show a title or a disc menu.
- For a disc with AVCHD files, title menu is displayed.

In such case, refer to "Using the Title / Disc / Pop-up Menu" on page 17.

To pause playback:

Press [II] (pause).

To return to the normal playback:

Press [▶] (play).

To stop playback:

Press [■] (stop).

Playback will be in Resume-On-Stop mode.

Resume-On-Stop mode

If a playback is in Resume-On-Stop mode, when you press [▶] (play) next time, the playback will start from the point where it has been stopped.

Note

- Resume playback may not be available for the BD that supports Java applications (BD-Java).

- In the "Disc" mode, the resume information will be cleared when;
 - [■] (stop) is pressed while in the Resume-On-Stop mode.
 - the parental level is changed.
 - the disc tray is opened.
- In the "SD Card" mode, the resume information will be cleared when;
 - [■] (stop) is pressed while in the Resume-On-Stop mode.
 - the SD Memory Card is removed.
 - the unit is turned into the standby mode.

Note

- ⊘ may appear at the top-right on the TV screen when the operation is prohibited by the disc or this unit.
- During the playback of 2-layered disc, pictures may stop for a moment. This happens when the 1st layer switches to the 2nd layer. This is not a malfunction.
- The operation may vary when you play back BD-videos, DVD-videos or AVCHD files with disc menu. Refer to the manual accompanying the disc for details.
- If a disc contains AVCHD files, the playback of other files on the same disc are not available. All files on an SD Memory Card are available.
- Set "Still Mode" setting to "Field" in "Video" menu if pictures in the pause mode are blurred. Refer to "Still Mode" on page 30.

Using the Title / Disc / Pop-up Menu

Many of BD-video and DVD-video discs contain title menu (BD-video / DVD-video / AVCHD), disc menu (DVD-video) or pop-up menu (BD-video) which guides you through the available functions in the disc. The contents of the menus may differ depending on the discs.

Title menu (BD-video / DVD-video / AVCHD)

- Press [TOP MENU].
- Use [▲/▼/◀/▶] to select an item, then press [OK].
- Press [TOP MENU] to exit.

Disc menu (DVD-video)

- Press [POP MENU / MENU].
- Use [▲/▼/◀/▶] to select an item, then press [OK].
- Press [POP MENU / MENU] to exit.

Pop-up menu (BD-video)

This is a special feature available for some BD-videos. When you press [POP MENU / MENU], a menu pops out on the TV screen during playback.

- During the playback of BD-video, press [POP MENU / MENU].
- Use [▲/▼/◀/▶] to select an item, then press [OK].
- Press [POP MENU / MENU] to exit.

Note

- Contents of menus and corresponding menu operations may vary among discs. Refer to the manual accompanying the disc for details.
- Title menu is also available for SD card with AVCHD files.

Playing Back (Audio CD / Windows Media™ Audio / JPEG Files)

Before you begin, make sure the correct media mode is selected. Refer to "Selecting the Media Mode" on page 16.

- Insert an audio CD or a disc/card with WMA / JPEG files.
- Use [▲/▼] to select a desired track, folder or file, then press [OK]. Use [◀/▶] to go back and forward between the hierarchies (only for WMA/JPEG files).
 - If you press [OK] on the desired file, playback will start.

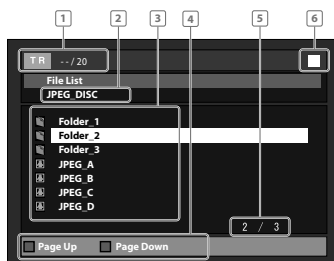

- audio CD: Track information
WMA/JPEG: File information
- audio CD: "CD-DA" will be displayed.
WMA/JPEG: Current Disc or folder name will be displayed.
- audio CD: List of the track number and time.
WMA/JPEG: List of the file / folder names in the current folder / disc
- Operation guide: Press [RED] to go to the previous page. Press [GREEN] to go to the next page.
- Current page / Total page number
- Playback status

Icons:

	Folder
	audio CD tracks
	WMA files
	JPEG files

3. Press [■ (stop)] to stop playback.

It is recommended that files to be played back in this unit are recorded under the following specifications:

<Windows Media™ Audio>

- Sampling frequency : 32 kHz, 44.1 kHz or 48 kHz
- Constant bit rate : 48 kbps - 192 kbps

<JPEG>

- Upper limit : 2,560 x 1,900 dots (sub sampling is 4:4:4)
5,120 x 3,840 dots (sub sampling is up to 4:2:2)
- Lower limit : 32 x 32 dots
- File size of image maximum : 12 MB

Note

- Unrecognizable characters will be replaced with asterisks.
- Some unplayable folders or files may be listed due to the recording status.
- High-resolution JPEG files take longer to be displayed.
- Progressive JPEG files (JPEG files saved in progressive format) cannot be played back in this unit.
- The system can recognize up to 255 folders / 999 files for CD, 999 folders / 9,999 files for BD, DVD and SD Memory Card.
- The 9th and deeper hierarchies cannot be displayed for CD. The 10th and deeper hierarchies cannot be displayed for BD, DVD and SD Memory Card.
- For the SD Memory Card playback, refer to "Reading the SD Memory Card" on page 16.
- Extension other than listed below cannot be recognized.
 - WMA : ".wma"
 - JPEG : ".jpg"/".jpeg"
- With regard to the multi-border BD-RE/-R, additionally recorded sections cannot be recognized.
- With regard to the multi-border DVD-RW/-R, additionally recorded sections may not be recognized.
- If a disc contains AVCHD files, the playback of other files on the same disc are not available. All files on an SD Memory Card are available.

KODAK Picture CD

This unit can also run JPEG files stored on KODAK Picture CD. You can enjoy picture images on the TV set by playing back the KODAK Picture CD. This unit conforms to ver.7.0 of KODAK Picture CD. For details of KODAK Picture CD, contact a shop that provides developing service of Kodak Inc.

1. When KODAK Picture CD is inserted in this unit, KODAK Picture CD menu will appear automatically on the TV screen.



- 1 File information
- 2 Current page / Total page number
- 3 Operation guide: Press [BLUE] to go to the previous page.
Press [YELLOW] to go to the next page.
- 4 Playback status

2. Use [▲/▼/◀/▶] to select a desired file to be played back, then press ► (play) or [OK].

- An image will be played back from the selected file and go to the next one in turn.

3. Press [■ (stop)] to stop playback.

To return to the first item:

Press [TOP MENU].

To return to the file played last:

Press [POP MENU / MENU].

Tips for JPEG / KODAK Picture CD Playback

- The selected file will be played back and go to the next file in the current hierarchy in turn every 10 seconds.
- Every press on [ANGLE] will turn the image clockwise by 90 degrees when an image is displayed.
- To change the visual effect for switching the playback image, press [MODE] once, then use [◀/▶] or [OK] to switch between "Cut In/Out" and "Fade In/Out".
- During JPEG / KODAK Picture CD playback, press [MODE] twice to change the size of the playback image, then use [◀/▶] or [OK] to switch between "Normal" (100 %) and "Small" (95 %). The size change may have no effect on some files (e.g. files with a small picture size).

Fast Forward / Fast Reverse

1. During playback, press [▶▶ (forward)] repeatedly for fast forward. During playback, press [◀◀ (reverse)] repeatedly for fast reverse. Every time you press [▶▶ (forward)] or [◀◀ (reverse)], the playback speed will change.
2. Press [▶ (play)] to return to normal playback.

Note

- For BD and DVD and AVCHD, speed changes in 5 different levels.
- For audio CD and Windows Media™ Audio, speed changes in 3 different levels.
- For audio CD, fast forward / fast reverse search between different tracks are not available during program and random playback.
- For Windows Media™ Audio, fast forward / fast reverse search between different files are not available.

Slow Forward Playback

1. During playback, press [|| (pause)], then press [▶▶ (forward)]. Every time you press [▶▶ (forward)], playback speed will change.
2. Press [▶ (play)] to return to normal playback.

Note

- For BD and DVD, speed changes in 3 different levels.
- Only slow forward is available.
- Set "Still Mode" setting to "Field" in "Video" menu if pictures in the slow forward playback mode are blurred. Refer to "Still Mode" on page 30.

Step by Step Playback

1. In pause mode, press [|| (pause)] repeatedly. Every time you press [|| (pause)], playback will advance one step at a time.
2. Press [▶ (play)] to return to normal playback.

Note

- Only step by step forward is available.
- Set "Still Mode" setting to "Field" in "Video" menu if pictures in step by step playback mode are blurred. Refer to "Still Mode" on page 30.

Repeat Playback

Available repeat functions vary depending the discs.

1. During playback, press [REPEAT] repeatedly to select the desired repeat mode.

Repeat mode	Available media
Chapter repeat	BD-video DVD-video AVCHD files
The current chapter will be played back repeatedly.	
Title repeat	BD-video DVD-video AVCHD files
The current title will be played back repeatedly.	
Track repeat	audio CD WMA file
The current track will be played back repeatedly.	
Group repeat	WMA file JPEG file
The current folder will be played back repeatedly.	
All repeat	audio CD WMA file JPEG file
All tracks or files in the media will be played back repeatedly.	

Note

- The repeat setting will be canceled when you stop playback.
- The chapter, title, track or group repeat will be cleared when moving to another chapter, title, track / file or folder.
- Chapter and title repeat are not available with some scenes.
- When the repeat setting is set for a WMA folder (file), the repeat setting will be canceled if you select other WMA folder (file) to playback.

Program Playback

You can play back the disc/card in your desired order.

1. In stop mode, press [MODE].
2. Use [▲/▼] to select a track / folder / file, then press [OK].

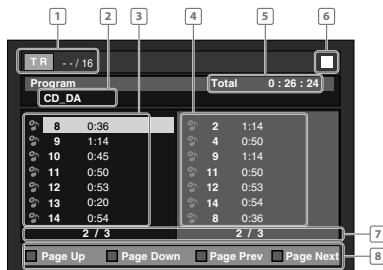

e.g.) audio CD

- 1 audio CD: Track information
WMA/JPEG: File information

- 2 audio CD: "CD-DA" will be displayed.
WMA/JPEG: Current Disc, SD Memory Card, or folder name will be displayed.
- 3 Track / Folder / File list in the original order
- 4 Programmed Track / File list in the list : programmed order
- 5 Cumulative playback time of all tracks in the programmed list (audio CD only)
- 6 Playback status
- 7 Current page / Total page number
- 8 Operation Press [RED] to go to the previous page in the track / file list.

Press [GREEN] to go to the next page in the track / file list.
Press [BLUE] to go to the previous page in the programmed list.
Press [YELLOW] to go to the next page in the programmed list.

- For WMA/JPEG files, use [▲/▼] to select a folder, then press [OK] first, and then use [▲/▼] to select a file, then press [OK].
- Press [CLEAR] to erase the last file of the program.
- Use [▲/▼] to select "All Clear" at the bottom of the list to erase all the tracks / files in the program.
- The programmed tracks / files is displayed in the right hand screen.
- Use [◀/▶] to go back / forward between the hierarchy of folders.

3. Press [▶ (play)] to start program playback.

- The program playback will start.
- To exit from the program playback mode:**
- Press [RETURN] in stop mode.

Note

- During program playback, press [■ (stop)] once to set the resume point, and then press [▶ (play)] to resume program playback from where [■ (stop)] was pressed (audio CD) or from beginning of the file where [■ (stop)] was pressed (WMA/JPEG).
- During program playback, press [■ (stop)] twice to display the program screen. To go back to the normal program playback, press [RETURN] to exit from the program screen, then press [▶ (play)].
- Up to 99 tracks / files can be entered.
- To repeat the current track / file in the program, press [REPEAT] repeatedly until "↶ Track" appears during playback. To repeat the entire program, press [REPEAT] repeatedly until "↶ All" appears during playback.

- Playback from a desired track / file and random playback are not available during program playback.
- Press [MODE] to switch to the random playback mode.
- The program will be cleared when;
 - the unit is turned into the standby mode.
 - the media mode is switched to the other mode.
 - the disc / card is removed. (as for "Disc" mode, just opening the disc tray will clear the program info.)

Random Playback

This function shuffles the playback order of tracks / files.

1. In stop mode, press [MODE] twice.

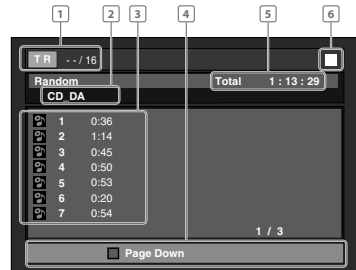



- 1 audio CD: Track information
WMA/JPEG: File information
- 2 audio CD: "CD-DA" will be displayed.
WMA/JPEG: Current Disc, SD Memory Card, or folder name will be displayed.
- 3 Track / File list: Track / File list in the original order will be displayed.
- 4 Operation Press [RED] to go to the previous page in the track / file list.
Press [GREEN] to go to the next page in the track / file list.
- 5 Total playback time of all tracks (audio CD only)
- 6 Playback status

2. Press [▶ (play)] to start random playback.

- To exit from the random playback mode:**
- Press [MODE] in stop mode.

Note

- During the random playback, press [■ (stop)] once to set the resume point, and then press [▶ (play)] to resume random playback from where [■ (stop)] was pressed (audio CD) or from beginning of the file where [■ (stop)] was pressed (WMA/JPEG).

- To repeat the current track / file in the random selection, press [REPEAT] repeatedly until  "Track" appears during playback. To repeat the entire random selection press [REPEAT] repeatedly until  "All" appears during playback.
- Playback from a desired track / file is not available during random playback.
- In stop mode, press [RETURN] to switch to the program playback mode.

Rapid Playback

This function plays back approximately at 1.3 times the normal playback while keeping the sound output. This function is available only on discs recorded in the Dolby Digital format.

1. During playback, press [MODE] repeatedly until the Rapid playback setting appears.

 **Off**

2. Press [OK] or [◀/▶] to switch (1.3x), or "Off".

"Off": Plays back in normal speed.

: Plays back approximately at 1.3 times of normal playback.

3. Press [▶] (play) to return to normal playback.

Note

- Picture adjustment and audio language setting cannot be changed during this function.
- Virtual surround does not work during this function.
- This function may not work at some points on a disc.
- During this function, 2ch LPCM will be output from HDMI OUT jack and DIGITAL OUT jack.

Adjusting the Picture

You can adjust the picture quality.

1. During playback, press [MODE] repeatedly until  appears.

2. Use [▲/▼] to select your desired item, then use [▶/◀] to adjust the setting.

 Black Level ◀ On ▶
 Noise Reduction Off

e.g.) DVD-video

■ Black level

You can adjust the black level setting to make the black parts of the pictures as bright as you prefer. You can select "On" or "Off".

"On": Makes the dark parts brighter.

"Off": Shows the original picture as recorded.

■ Noise reduction (DVD-video only)

Reduces the noise of the playback picture.

"Off": Shows the original picture as recorded.

"1": Executes 3D noise reduction which detects and deletes the noise by comparing each picture frames.

"2": Executes MPEG noise reduction which reduces the block noise and mosquito noise on the subtitle on movie.

"3": Executes both MPEG noise reduction and 3D noise reduction.

3. Press [RETURN] to exit.

Note

- The setting will remain the same even if the unit is turned to the standby mode.
- "Black Level" is not effective under the following conditions.
 - When the picture is output from HDMI OUT jack.
- You cannot adjust the setting during rapid playback.

Virtual Surround

You can enjoy stereophonic virtual space through your existing 2 channel stereo system.

1. During playback, press [MODE].

2. Use [▲/▼] to select your desired setting.

 **Off**

"Off": No surround effect

"1": Natural surround effect

"2": Stronger surround effect

3. Press [RETURN] to exit.

Note

- Set the virtual surround setting to "Off" or lower the volume if the sound is distorted.
- Virtual surround does not function during rapid playback.
- For the virtual surround, audio signal will always be 2-channel LPCM.

PIP (BONUSVIEW) Setting

Some BD-videos have the PIP function which enables you to display the secondary video in the primary video. You can call up the secondary video by pressing [MODE] whenever the scene contains the secondary video.

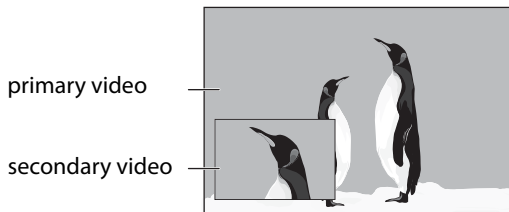

1. During playback, press [MODE] repeatedly until the PIP function appears.
2. Use [▲/▼] to select the secondary video you want.
 - The secondary video will be displayed and the secondary audio will be output.
 - Use [◀▶] to switch between current setting and "Off".
3. Press [RETURN] or [MODE] to remove the PIP information.

Note

- The secondary audio will not be output when the secondary audio is set to "Off" or when "BD Audio Mode" is set to "HD Audio Output". Refer to "Switching Audio Soundtrack" on page 24 and "Setting the BD Audio Mode" on page 24.

Camera Angle

Some BD-videos and DVD-videos contain scenes which have been shot simultaneously from various angles. You can change the camera angle when  appears on the TV screen.

1. During playback, press [ANGLE].
 - The selected angle will be displayed on the display bar at the top of the TV screen.
2. Use [▲/▼] to select your desired angle.



Note

- If "Angle Icon" setting is "Off" in "Others" menu,  will not appear. Refer to page 36.

Enjoying BD-Live Discs with Internet

You can enjoy BD-Live which enables you to use interactive features when the unit is connected to the Internet. (For network connection, refer to page 39.) Examples of BD-Live features:

- Online access to additional content such as movie trailers, subtitles, BD-Java applications, etc.
- While downloading, special video data may be played back.

■ How to Activate the BD-Live Function

1. Insert the disc with BD-Live function.
2. Insert an SD card with enough capacity. (SD card of 1GB or more is recommended.)
 - Make sure to use the SD card with the supported file system. (Refer to "Reading the SD Memory Card" on page 16.)
3. Press [TOP MENU] to access the disc menu.
4. Select "BD-Live", then press [▶ (play)] or [OK].
 - Make sure the SD card is correctly inserted, and do not remove the card during playback.
 - Service and functions differ depending on the disc. Follow the instructions given by the disc when using the BD-Live function.

Note

- You must connect the unit to the Internet and set up necessary settings in order to use BD-Live.
- For certain discs, "BD-Live Setting" may need to be changed.
- Depending on your connection environment, it may take time to connect to the Internet or the Internet may not be connected.
- When BD-Live functions are used and the unit is connected to the Internet, you may be charged for this communication.
- While connecting to BD-Live, sometimes it can take awhile before the next page is downloaded or refreshed.
- Some discs with BD-Live function require memory when playing back the content. If you cannot play back a disc with BD-Live function, insert an SD card (1GB or more) which is formatted on this unit.

Note for AACs Online

- The player or disc IDs may be sent to the content provider when playing back a disc with BD-Live function.
- If you save your viewing history on the server by using these IDs, you will be introduced to other similar movies.
- You can save game score histories.

Search

■ Using [◀◀/▶▶] (skip)



1. During playback, press [▶▶] (skip) to move to the next track / title / chapter / file. Press it repeatedly to skip to subsequent tracks. Press [◀◀] (skip) once to go back to the beginning of the current track. Press it repeatedly to go to the previous tracks.
 - For JPEG files, press [◀◀] (skip) to go back to the previous file.

Note

- For BD and DVD, if title contains no chapters, [◀◀/▶▶] (skip) changes the title.
- For JPEG files, [◀/▶] is also available.

■ Using [SEARCH]

By using [SEARCH], you can select the following search modes.

Search mode	Available media
 / TT Chapter / Title search	BD-video DVD-video AVCHD file
TR Track search	audio CD WMA file JPEG file
 Time search	BD-video DVD-video audio CD AVCHD file

1. During playback, press [SEARCH] repeatedly until your desired search mode appears.
2. Enter the desired chapter, title, track, file number or time to search for using [the Number buttons].
 - Chapter, title, track or time search will start.
 - Press [CLEAR] to erase an incorrect input.

Note

- During program and random playback, search functions are not available except the search using [◀◀/▶▶] (skip).
- Time search is available only in the same track, file or title.
- For BD / AVCHD, chapter and time search are available only during playback.

Using [the Number buttons] (Direct Search)

■ Title search

In stop mode, enter the title number you want to search using [the Number buttons].
Playback of the title will start in a few seconds.

■ Chapter search

During playback of a title, enter the chapter number you want to search using [the Number buttons].
Playback of the chapter will start in a few seconds.

■ Track / file search

Enter the track / file number you want to search using [the Number buttons].
Playback of the track / file will start in a few seconds.

Note

- As for the BD-video, how it performs will be strongly determined by the disc, and may not perform as described here.

Switching Subtitles

Some video materials may have subtitles in 1 or more languages. For commercially available discs, the supported languages can be found on the disc case. Follow the steps below to switch the subtitle languages during playback.



1. During playback, press [SUBTITLE].
2. Use [▲/▼] to select "Primary Subtitle", "Secondary Subtitle" or "Subtitle Style", then press [OK].

Primary Subtitle	2	ENG	/11
Secondary Subtitle	2	ENG	/11
Subtitle Style	2/25		

- "Primary Subtitle": Sets the subtitle for the primary video.
- "Secondary Subtitle": Sets the subtitle for the secondary video.
- "Subtitle Style": Sets style of the subtitle.

3. Use [▲/▼] to select your desired subtitle or style.
 - Use [◀/▶] to switch between current subtitle setting and "Off".
4. Press [SUBTITLE] to exit.



1. During playback, press [SUBTITLE].
2. Use [▲/▼] to select your desired subtitle.
 - Use [◀/▶] to switch between current subtitle setting and "Off".



3. Press [SUBTITLE] to exit.

Note

- Some discs will only allow you to change the subtitles from the disc menu or pop-up menu. Press [TOP MENU] or [POP MENU / MENU] to display the disc menu or pop-up menu.
- If 4-digit-language code appears in the subtitle menu, refer to "Language Code List" on page 48.
- If the disc has no subtitle language or subtitle style, "Not Available" will be displayed on the TV screen.
- During playback of the secondary video, the primary subtitle setting is not available except when there is no subtitle for the secondary video.
- If you select a language that has a 3-letter-language code, the code will be displayed every time you change the subtitle language setting. If you select any other languages, "----" will be displayed instead. (Refer to page 48.)

Switching Audio Soundtrack

When playing back video material recorded with 2 or more soundtracks (these are often in different audio languages or audio formats), you can switch them during playback.



1. During playback, press [AUDIO].
2. Use [▲/▼] to select "Primary" or "Secondary" audio to set, then press [OK].

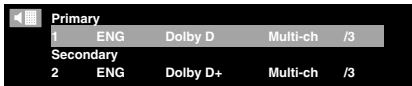

"Primary": Sets the audio for the primary video.

"Secondary": Sets the audio for the secondary video.

3. Use [▲/▼] to select your desired audio stream channel.
 - For "Secondary", use [◀/▶] to switch between current audio setting and "Off".
4. Press [AUDIO] to exit.



1. During playback, press [AUDIO].
2. Use [▲/▼] to select your desired audio stream channel.



- For audio CD, you can select following options.

"Stereo": Both right and left channels are active (stereo).

"L-ch": Only left channel is active.

"R-ch": Only right channel is active.

3. Press [AUDIO] to exit.

Note

- The secondary audio will not be output when the secondary video is not displayed or when "BD Audio Mode" is set to "HD Audio Output". (For some BDs, secondary audio will be output even when secondary video is off.)
- The sound mode cannot be changed during playback of discs not recorded in multiple audio.
- Some discs allow changing the audio language setting on the disc menu. (Operation varies depending on the discs. Refer to the manual accompanying the disc.)
- [AUDIO] may not work on some discs with multiple audio streams or channels (e.g. DVDs that allow changing audio setting on the disc menu).
- If you select a language that has a 3-letter-language code, the code will be displayed every time you change the audio language setting. If you select any other languages, "----" will be displayed instead. (Refer to page 48.)
- Audio Language selection cannot be made during rapid playback. (Refer to page 21.)
- If 4-digit-language code appears in the audio menu, refer to page 48.
- If the disc has no audio language, "Not Available" will be displayed on the TV screen.
- For DTS-CD (5.1 music disc), selecting audio streams or channels is not available.

Setting the BD Audio Mode

There are 2 options for the "BD Audio Mode" setting; either by setting the output to the secondary and interactive audio accompanied by the primary audio or by setting only the primary audio. Depending on the setting of the mode, Dolby Digital, Dolby Digital Plus, Dolby TrueHD, DTS, or DTS-HD output changes between multi LPCM and Bitstream.

1. In stop mode with BD inserted, press [MODE].
2. Use [▲/▼] to select your desired setting.



"Mix Audio Output":

If it is available, BD-video's secondary and interactive audio will be output with the primary audio.

- The secondary audio is the audio for the secondary video (Director's comment etc.) and the interactive audio is the audio for the interactive application (Button click sounds etc.).

"HD Audio Output":

Only the primary audio will be output. Set this mode in order to output, Dolby Digital Plus, Dolby TrueHD, or DTS-HD audio of BD through HDMI connection.

3 Press [RETURN] to exit.

- You can also set “BD Audio Mode” from the setup menu. Refer to page 31.

Note

- In “Mix Audio Output” mode, if there is no secondary and interactive audio, the audio will be output as “HD Audio Output” mode.

NETWORK OPERATIONS

Netflix Operations

With this unit, you can watch movies and TV episodes streamed instantly from Netflix (version 1.6) via the Internet. In order to use this feature, you must visit the following website on your PC and become a Netflix member. netflix.com/sylvania

Before Activating the Connection to Netflix

After creating a Netflix account at netflix.com/sylvania, follow the following procedure before activating the connection to Netflix.

1. Connect this unit to the Internet.

- Refer to “Connection to the Network” on page 12.

2. Set up the necessary network connection settings.

- Refer to “Network Connection” on page 39.

Activating the Connection to Netflix

In order to watch movies and TV episodes streamed instantly from Netflix via the Internet, you must activate the connection between this unit and your Netflix account.

1. Press [GREEN] while opening screen is displayed.

- For opening screen, refer to page 9.
- Netflix welcome screen will appear.
- For the first time only, “Network Service Disclaimer” screen will appear. After confirming the content, use [◀/▶] to select “Agree”, then press [OK].

2. Use [▲/▼] to select “yes - activate instant streaming from Netflix”, then press [OK].

- Activation screen with the activation code will appear.



3. On your PC, visit netflix.com/activate and log into your account.

- The entry screen of activation code will appear on your PC screen.

4. Enter the activation code which is displayed on the TV screen.

- The instant Queue will appear. The connection to Netflix is successfully made.
- To browse the instant Queue and watch movies, skip to step 2 in “Watching Streaming Movies” on page 25.

Note

- Netflix is available only in the United States.
- You cannot create a Netflix account on this unit.
- If newer version of software is required, software update screen may appear after selecting “NETFLIX” in step 1. (For software update, refer to “Software Update” on page 43.)
- You can deactivate the connection to Netflix by setting “Netflix Deactivate” to “Yes”. (Refer to page 44.)
- The screen image of Netflix may change after updating the firmware.
- For questions regarding the Netflix service, visit netflix.com/Help
- When you contact the Netflix customer service, you may be asked for the ESN number, which is a serial number to identify this unit by Netflix. You can check the ESN number on the bottom of the “Netflix Deactivate” screen. (Refer to page 44.)

Watching Streaming Movies

After you set up the connection to Netflix, you can browse the instant Queue and watch movies on your TV.

1. Press [GREEN] while opening screen is displayed.

For opening screen, refer to page 9. The instant Queue will appear.

2. Use [◀/▶] to select the desired movie or TV episode, then press [▶ (play)] to start playback.



- After loading, playback of the selected movie or TV episode will start.
- To stop the playback, press [■ (stop)].
- To go back to the instant Queue, press [RED].
- To go back to the opening screen, press [TOP MENU] or [SETUP].

About the Instant Queue

- Instant Queue is the list of movies and TV episodes you add on the Netflix website (netflix.com). You can manage the movies and TV episodes in your instant Queue from the Netflix website on your PC.

- You cannot add movies or TV episodes to your instant Queue on this unit.
- You can remove movies or TV episodes from the instant Queue on this unit.

Note

- The picture quality differs depending on the speed of your Internet connection at the time of loading.

CinemaNow / Blockbuster Operations

With this unit, you can watch movies and TV episodes streamed instantly from CinemaNow / Blockbuster via the Internet. In order to use this feature, you must visit the following website and create a CinemaNow / Blockbuster account.

- For CinemaNow, visit www.cinemanow.com/Login
- For Blockbuster, visit www.blockbuster.com/auth/login

Before Activating the Connection to CinemaNow / Blockbuster

After creating a CinemaNow / Blockbuster account, follow the following procedure before activating the connection to CinemaNow / Blockbuster.

- 1. Connect this unit to the Internet.**
 - Refer to “Connection to the Network” on page 12.
- 2. Set up the necessary network connection settings.**
 - Refer to “Network Connection” on page 39.

Activating the Connection to CinemaNow / Blockbuster

In order to watch movies and TV episodes streamed instantly from CinemaNow / Blockbuster via the Internet, you must activate the connection between this unit and your CinemaNow / Blockbuster account.

1. On your PC, visit following website and log into your account to get the activation code.

- Follow the instruction given by the website.
- Take a note of the activation code which appears on the PC.
 - For CinemaNow, visit www.cinemanow.com/activate
 - For Blockbuster, visit www.blockbuster.com/sylvania

2. On this unit, press [YELLOW] or [BLUE] while opening screen is displayed.

- For opening screen, refer to page 9.
- Menu screen of CinemaNow / Blockbuster will appear.
- For the first time only, “Network Service Disclaimer” screen will appear. After confirming the content, use [◀▶] to select “Agree”, then press [OK].

3. Use [◀▶] to select “Settings” (CinemaNow) or “Configure” (Blockbuster), then press [OK].

- For CinemaNow, select “Activate” and press [OK] again in the next screen.
- Activation code input screen will appear.

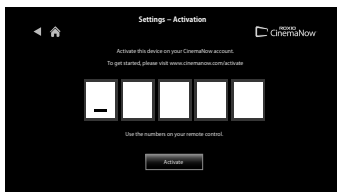

e.g.) CinemaNow

4. Enter the activation code displayed on your PC using [◀▶] and [the Number buttons], then select “Activate” and press [OK].

- For CinemaNow, confirmation message will appear. Press [OK] to complete the setting.

Note

- The image of menu screen may change after updating the firmware.
- You cannot create CinemaNow / Blockbuster account on this unit.
- To deactivate the connection to CinemaNow / Blockbuster, select “Deactivate” in “Settings” (CinemaNow) or “Configure” (Blockbuster).
- For questions regarding CinemaNow service, visit www.cinemanow.com/support
- For questions regarding Blockbuster service, visit www.blockbuster.com/help

Guide to CinemaNow / Blockbuster Menu Screen

CinemaNow

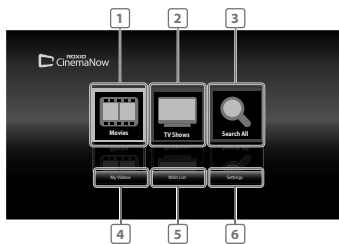

Blockbuster

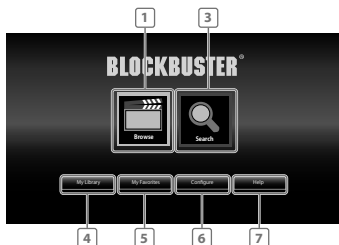

1 Movies / Browse:	To access the movie list
2 TV Shows:	To access the TV show list
3 Search All / Search:	To access search screen
4 My Videos / My Library:	To access the list of rented or purchased movies / TV episodes
5 Wish List / My Favorites:	To access your wish list / favorite list
6 Settings / Configure:	To access setting / configure menu
7 Help:	To access the help page

Renting or Purchasing Movies / TV Episodes

After you set up the connection to CinemaNow / Blockbuster, you can rent or purchase movies / TV episodes and watch directly on your TV.

1. Press [YELLOW] or [BLUE] while opening screen is displayed.
 - For opening screen, refer to page 9.
2. Use [▲/▼/◀/▶] to select "Movies", "Browse" or "TV Shows" then press [OK].
 - List of movies / TV episodes will appear.
3. Use [▲/▼/◀/▶] to select the desired title, then press [OK].
 - Title details screen of the selected title will appear.
4. Use [◀/▶] to select "Rent" or "Buy", then press [OK].
 - Checkout screen will appear.
5. Use [◀/▶] to select "Submit Order", then press [OK].
6. Use [◀/▶] to select "Play Now", then press [OK].
 - If you want to continue browsing, select "Continue Browsing" and press [OK] to go back to "Movies", "Browse" or "TV Shows".

Note

- If you select "Add to Wish List" or "Add to My Favorites" in title details screen, the title will be added to your "Wish List" or "My Favorites".
- For CinemaNow, if you want to redeem a gift code, select "Redeem Gift Code" in the checkout screen, then press [OK] and enter the gift code.
- In most cases, rented movies or TV episodes are available for 24 hours from the playback starting time.

Searching Movies / TV Episodes

From the search screen, you can search for movies / TV episodes by entering search words.

1. Follow step 1 in "Renting or Purchasing Movies / TV Episodes" on page 27.
2. Use [▲/▼] to select "Search All" or "Search", then press [OK].
 - Keypad screen will appear.
3. Use [▲/▼/◀/▶] to select characters, then press [OK].
 - When you enter a letter, titles that start with the letter will be displayed on the right side of the screen.

4. Use [▲/▼/◀/▶] to select a desired title from the search result on the right side of the screen, then press [OK].

- Title details screen of the selected title will appear.

Watching Rented or Purchased Movies / TV Episodes

1. Follow step 1 in "Renting or Purchasing Movies / TV Episodes" on page 27.
2. Use [▲/▼/◀/▶] to select "My Video" or "My Library", then press [OK].
 - List of rented or purchased movies / TV episodes will appear.
3. Use [▲/▼/◀/▶] to select a desired title, then press [OK].
4. Use [◀/▶] to select "Watch from Start" or "Play Now", then press [OK].
 - If you want to resume playback, select "Resume Play" and press [OK].
 - To stop the playback, press [■](stop).
 - To pause the playback, press [⏸](pause).
 - To go back to the opening screen, press [TOP MENU] or [SETUP].

Note

- Depending on your network environment and speed, the playback may be paused or stopped. To improve playback condition, use high speed broadband Internet connection (For details, contact your Internet service provider.)

VUDU Operations

With this unit, you can enjoy VUDU HD on-demand movies / TV episodes and Internet applications.

- For complete instructions on using VUDU service, please visit www.vudu.com/docs to view an updated in-depth online manual.

Before Activating VUDU

Follow the following procedure before activating VUDU.

1. Connect this unit to the Internet.
 - Refer to "Connection to the Network" on page 12.
 - Broadband Internet connection of 8 Mbps or faster is recommended.
2. Set up the necessary network connection settings.
 - Refer to "Network Connection" on page 39.

Activating VUDU

After you set up the network connection, you must set up a VUDU account and activate this unit before watching VUDU movies.

1. Press [RED] while opening screen is displayed.

- For opening screen, refer to page 9.
- VUDU App Home screen will appear.
- For the first time only, "Network Service Disclaimer" screen will appear. After confirming the content, use [◀▶] to select "Agree", then press [OK].

2. Use [▲/▼/◀▶] to select "VUDU movies", then press [OK].

- VUDU welcome screen will appear.

3. Select "SIGN Up Now", then press [OK].

4. Enter the e-mail address you would like associated with your VUDU account. After you enter your e-mail address correctly, select "Done" and press [OK].

- Activation e-mail will be sent to the e-mail address. (You must have access to the e-mail address to activate VUDU.)

5. Follow directions in the activation e-mail to complete your account activation.

Note

- You can deactivate the connection to VUDU by setting "Vudu Deactivate" to "Yes". (Refer to page 44.)
- For questions regarding VUDU service, please contact VUDU Customer Care at 1-888-554-VUDU (8838) or visit www.vudu.com/support

Guide to VUDU Menu Screen

■ App Home Screen

App Home screen is the entry point to VUDU applications including VUDU movies. To call up the screen, press [RED] while opening screen is displayed.

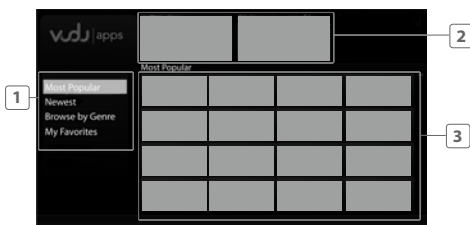

1. Viewing mode :	List of different viewing modes for App Home applications
2. Promotional graphics :	Placeholder where promotional graphics are displayed
3. Application list :	Grid of applications in the selected viewing mode

■ VUDU Movies Home Screen

When you select "VUDU movies" in App Home screen, VUDU movies home screen will appear.



1. Most Watched :	To access the list of popular movies / TV episodes on VUDU
2. New on Vudu :	To access the list of newly available movies /TV episodes
3. Explore Catalog :	To access the list of options to search movies / TV episodes
4. My Vudu :	To access the list of rented or purchased contents

Note

- You can go back to VUDU movies home screen by pressing [BLUE] while you are using VUDU movies features.

Renting or Purchasing VUDU Movies / TV Episodes

After activating this unit, you are ready to purchase or rent movies / TV episodes and watch directly on your TV.

1. Press [RED] while opening screen is displayed.

- For opening screen, refer to page 9.

2. Use [▲/▼/◀▶] to select "VUDU movies", then press [OK].

- VUDU movies home screen will appear.

3. Use [▲/▼/◀▶] to select "Most Watched", "New on Vudu" or "Explore Catalog", then press [OK].

4. Use [▲/▼/◀▶] to select the desired movie or TV episode, then press [OK].

- "MOVIE DETAILS" screen will appear.

5. Use [▲/▼] to select "Rent" or "Own", then press [OK].

6. Use [▲/▼] to select a desired quality option, then press [OK].

- Select the quality option that best suits your network environment.

	Video Resolution	Minimum Bit Rate
SD	480p	1 Mbps
HD	720	2.25 Mbps
HDX	1080p	4.5 Mbps

7. Use [▲/▼] to select "Rent for \$*.***" or "Buy for \$*.***", then press [OK] to confirm your rental or purchase.

8. Select "Watch Now" to start playing the movie / TV episode.

- If you want to return to the “MOVIE DETAILS”, select “Watch Later”.

Note

- Available quality options differ depending on the content.

Watching Rented or Purchased VUDU Movies / TV Episodes

1. Follow steps 1 to 2 in “Renting or Purchasing VUDU Movies / TV Episodes” on page 28.
2. Use [◀/▶] to select “My Vudu”, then press [OK].
3. Use [◀/▶] to select “My Rentals”, “My Movies” or “My TV Shows”, then press [OK].
4. Use [▲/▼] to select a desired movie / TV episode, then press [OK].
5. Select “Watch ***” to start watching the movie / TV episode.
 - During playback, use following buttons to control the playback.

Button	Action
[(pause)]	Pause the playback.
[■ (stop)]	Stop the playback.
[◀◀ (reverse)] / [▶▶ (forward)]	Fast reverse or forward the playback.
[▶ (play)]	Resume the playback.
[YELLOW]	Display the info banner which shows the playback information.
[TOP MENU]	Go back to opening screen.

Note

- Available buttons and actions may subject to change without notice.

Using Internet Applications

In addition to VUDU movies, you can use various kinds of Internet applications.

1. In App Home screen, use [▲/▼/◀/▶] to select a desired application and press [OK].
2. Follow the instructions on screen of the selected application.

Note

- Available applications may change without notice.

FUNCTION SETUP

In the setup menu you can change the setting for audio, video, language, etc. You cannot change the setting during playback. Setting items displayed in gray indicates they are not available under the conditions at the time.

Quick

“Quick” menu contains setting items extracted from “Custom” menu which may be used frequently.

1. In stop mode, press [SETUP].
2. Use [▲/▼] to select , then press [OK].
3. Use [▲/▼] to select your desired setting items.

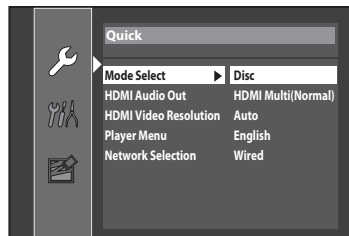







4. Follow the procedure below depending on the setting items.

- A) If “▶” does not appear on the right side of the setting items when you select the items: Press [OK] repeatedly to change options.
- B) If “▶” appears on the right side of the setting items when you select the items:
 - 1) Press [OK].
 - 2) Use [▲/▼] to select options, then press [OK].
 - Use [◀] or [RETURN] to go back to the previous screen.

5. Press [SETUP] to exit.

Custom

"Custom" menu contains all the setting items.

1. In stop mode, press [SETUP].
2. Use [▲/▼] to select , then press [OK].
3. Use [▲/▼] to select your desired setting category, then press [OK].
 - : Language
 - : Video
 - : Audio
 - : Parental
 - : Others
4. Use [▲/▼] to select your desired setting items.
5. Follow the procedure below depending on the setting items.

- A) If "▶" does not appear on the right side of the setting items when you select the items: Press [OK] repeatedly to change options.
- B) If "▶" appears on the right side of the setting items when you select the items:
 - 1) Press [OK].
 - 2) Use [▲/▼] to select options, then press [OK].
 - Use [◀] or [RETURN] to go back to the previous screen.

6. Press [SETUP] to exit.

Language



- To select the setting items and options, refer to "Custom" on page 30.
- "Quick" menu consists of the setting menus frequently used, and they are accompanied with .

Setting items	Descriptions
Audio	Sets the language for audio.
Subtitle	Sets the language for subtitle.
Disc Menu	Sets the language for disc menu or pop-up menu.
Player Menu  *1	Sets the language for on-screen display.

- *1) "Auto" for "Player Menu" activates the Get & Set Menu Language function. Refer to page 38.
- "Auto" is available only when "fun-Link (HDMI CEC)" is set to "On".

- inside the parentheses next to "Auto" will be the language which is currently selected by your TV.

- For "Audio", "Subtitle", and "Disc Menu", if you select "Other", enter the 4-digit-number code for the desired language. (Refer to "Language Code List" on page 48.) Only the languages supported by the disc can be selected.

Video

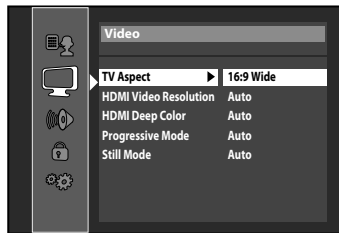

- To select the setting items and options, refer to "Custom" on page 30.
- "Quick" menu consists of the setting menus frequently used, and they are accompanied with .

Setting items	Descriptions
TV Aspect	Sets the picture size according to aspect ratio of the connected TV.
HDMI Video Resolution 	Sets the HDMI video resolution.
HDMI Deep Color	Sets whether to output the picture from HDMI OUT jack with Deep Color or not.
Progressive Mode	Sets the optimum progressive mode for the image material output from HDMI OUT jack.
Still Mode *1	Adjusts picture resolution and quality in still mode.

- *1) An individual picture on the TV screen is called "Frame", which consists of two separate images called "Field". Some pictures may be blurred at the auto setting in "Still Mode" setting due to their data characteristics.



Note for “HDMI Video Resolution”

- Even if you set “HDMI Video Resolution” setting to “Auto”, when this unit is connected to a DVI compatible display devices with an HDMI-DVI cable, 480p signal will be output.
- Video and audio signals may be distorted temporarily when switching to / from the HDMI output mode.
- You cannot change the video resolution during playback of Blu-ray Discs or AVCHD files. To change the resolution, stop playback.
- In order to get natural and high quality film reproduction of 24-frame film material, use an HDMI cable (High Speed HDMI cable is recommended) and select “Auto” if the connected TV is compatible with 1080p24 frame input.
- Even if the connected TV is compatible with 1080p24 frame input and you set “HDMI Video Resolution” setting to “Auto”, when the contents of the disc are not compatible for 1080p24 frame, 1080p60 frame will be output.
- If the picture is not output properly to the TV because of “HDMI Video Resolution”, press and hold [▶ PLAY] on the front panel for more than 5 seconds. Both settings will be reset to the default automatically.
- For AVCHD, 24-frame film material will be output as 60 frame, even if the connected device is compatible with 1080p24 frame input and “HDMI Video Resolution” is set to “1080p24” or “Auto”.

Setting items	Descriptions
BD Audio Mode	For BD, selects whether to output the secondary and interactive audio with primary audio if it is available or only the primary audio. Refer to “Setting the BD Audio Mode” on page 24.
HDMI Audio Out  *1	Sets the audio format for the audio output from HDMI OUT jack. Refer to page 32.
Down Sampling	Sets the digital audio output when playing back BD or DVD recorded in LPCM.
DRC	Sets whether to compress the range of sound volume (dynamic range control) when Dolby Digital, Dolby Digital Plus or Dolby TrueHD audio is played back. When “Auto” is selected, this unit detects DRC setting of the disc and set “DRC” setting to “On” or “Off” automatically when the discs recorded in Dolby TrueHD format are in playback.

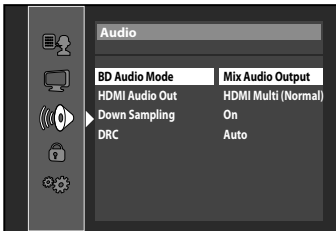
Audio



- To select the setting items and options, refer to “ Custom” on page 30.
- “ Quick” menu consists of the setting menus frequently used, and they are accompanied with .

- *1) Under following circumstances, “HDMI Multi(Normal)” and “HDMI Multi(LPCM)” are not available.
- HDMI cable is not connected to HDMI OUT jack.
 - Connected TV is off.
 - Connected TV is not compatible with audio output.

HDMI Audio Out Setting

When using HDMI connections make “HDMI Audio Out” setting in “Audio” menu according to the specifications of the device to be connected. Refer to page 31. Normally, set it to “HDMI Multi(Normal)” so that the unit automatically picks and outputs the best audio format suited to your connected device.

Device to be connected	“HDMI Audio Out” setting	Output HDMI audio signal
Device compatible with Dolby Digital, Dolby Digital Plus, Dolby TrueHD, DTS or DTS-HD decoding	HDMI Multi(Normal)	Dolby Digital, Dolby Digital Plus, Dolby TrueHD, DTS, or DTS-HD bitstream are output from HDMI OUT jack. Make the speaker settings on the connected AV amplifier, etc.
Device compatible with 3 or more channels of audio inputs (not Dolby Digital, Dolby Digital Plus, Dolby TrueHD, DTS or DTS-HD compatible)	HDMI Multi(LPCM)	Multi-channel audio signals are output from HDMI OUT jack. Make the speaker settings with the speaker setting items appear after you select “HDMI Multi(LPCM)”.
HDMI connection to a TV and digital audio connection (coaxial) to an AV amplifier	Audio Mute	HDMI audio will be mute, and Dolby Digital / DTS bitstream or LPCM will be output from DIGITAL OUT jack depending on “Digital Out” setting.

Note

- The audio signals from HDMI OUT jack (including the sampling frequency, the number of channels and bit length) maybe limited by the device that is connected.
- Among the devices that support HDMI, some do not support audio output (e.g. projectors). In connections with device such as this unit, audio signals are not output from HDMI OUT jack.
- Video and audio signals may be distorted temporarily when switching to / from the HDMI output mode.

Digital Out Setting

When “Audio Mute” is selected in “HDMI Audio Out” setting, HDMI audio signal will be mute and the audio signals output from DIGITAL OUT jack changes depending on “Digital Out” setting.

Quick ⇒ HDMI Audio Out ⇒ Audio Mute ⇒ Digital Out
Bitstream* : When playing back discs recorded in Dolby Digital, Dolby Digital Plus, Dolby TrueHD, DTS® or DTS-HD®, the corresponding core stream (Dolby Digital or DTS®) are output.
LPCM : LPCM signal will be output from DIGITAL OUT jack.

- This setting is not effective when the HDMI audio signal is output.

Note

- In order to output LPCM signal from DIGITAL OUT jack while outputting the HDMI audio signal, set “HDMI Audio Out” setting to “HDMI Multi(LPCM)”.

Speaker Setting (Available when you have HDMI cable connected to HDMI OUT jack)

This unit allows you to enjoy multi-channel surround sound such as 7.1-channel / 5.1-channel surround. To make the most of its feature, set up your speakers appropriately by referring to the following table.

How to navigate through "HDMI Multi(LPCM)":

- 1) Use [▲/▼] to select your desired menu item then press [OK].
- 2) Use [▲/▼] to select your setting items.
 - Press [RETURN] to go back to the previous screen.
- 3) Use [◀/▶] to select desired options. (Except for "Test Tone", "Default" and setting options in "Speaker Size" setting.)
For setting options in "Speaker Size" setting: Press [OK] to select desired options.

For "Test Tone":

Use [◀/▶] to select "Off", "Manual" or "Auto", then press [OK].

- The test tone will be output. If you select "Manual", use [▲/▼] to select desired speaker, then use [◀/▶] to adjust the volume. If you select "Auto", use [◀/▶] to adjust the volume of the speaker that outputs the test tone.
- If you want to stop the test tone, press [RETURN].

For "Default":

Press [OK] to reset to the default.

- 4) Press [SETUP] to exit.

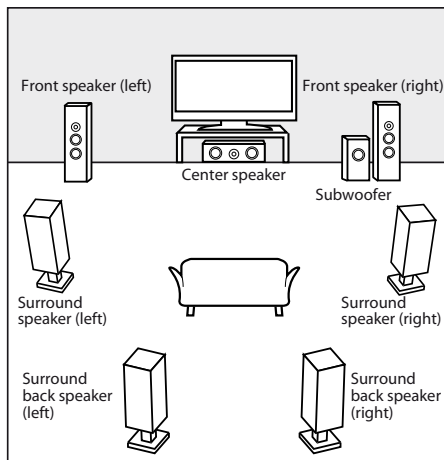

e.g.) basic layout with 7.1-channel surround system

<Speaker setting for the audio signal output from HDMI OUT jack>

Quick ⇒ HDMI Audio Out ⇒ HDMI Multi(LPCM)

Custom ⇒ Audio ⇒ HDMI Audio Out ⇒ HDMI Multi(LPCM)

Menu	Setting items	Descriptions
Speaker Size Selects the desired speaker to set. Then change the setting by referring to the descriptions.	Front	Large: For the large speakers with strong low frequency reproduction capabilities.
	Center	
	Subwoofer	
	Surround	Small: For the small speakers which do not provide strong bass sound. You cannot change the setting of "Subwoofer". Speakers which are not supported by the connected device will be displayed in gray.
	Surround Back	
	Default	
	Default	Select "Default", then press [OK] to reset "Speaker Size" setting to the default.

Menu	Setting items	Descriptions
Channel Level Tests or sets the volume for each speaker.	Test Tone: "Test Tone" is the test tone which can be output from the speakers so you can adjust the volume for each speaker.	Select "Off" to deactivate "Test Tone". Select "Manual", then press [OK] to manually set the volume for the desired speaker. Select "Auto", then press [OK] to automatically output the test tone from each speaker.
	Front Lch	If you have selected "Manual" in "Test Tone", select the desired speaker to set and adjust the volume for the selected speaker. If you select "Auto" in "Test Tone", test tone will automatically be output in order. Adjust the volume of the speaker that outputs the test tone.
	Center	
	Subwoofer	
	Front Rch	
	Surround Rch	
	Surround Back Rch	
	Surround Back Lch	
Surround Lch	Select "Default", then press [OK] to reset "Channel Level" setting to the default.	
Delay Time This is a parameter for optimizing the timing at which the sound outputs from the speakers according to the distance from the listening position.	Distance	Set the desired measure system. This measure system will be used for "Delay Time" setting. Press [OK] to switch the settings.
	Front	Select the distance from the listening position to the speaker to get the ideal delay time.
	Center	
	Surround	
	Surround Back	Select "Default", then press [OK] to reset "Delay Time" setting to the default.
Default		

- For "Speaker Size" setting, the settings of each speaker size may be adjusted automatically corresponding to each setting. (e.g. If "Front" is set to "Small", you cannot set "Center", "Surround", and "Surround Back" to "Large".)
- For "Delay Time", the difference between the value of the "Front", "Surround" and "Surround Back" setting cannot exceed 15 ft (4.5m), and the difference between the value of the "Front" and "Center" setting cannot exceed 5 ft (1.5m).
- For "Delay Time", the value of the "Center", "Surround" and "Surround Back" setting cannot exceed the value of the "Front" setting.
- For "Delay Time", the setting of "Center", "Surround" and "Surround Back" will be changed automatically to the setting value of the "Front". (e.g. If the "Front" is set to 60ft (18m), the setting of "Center", "Surround" and "Surround Back" will be changed to 60ft (18m) as well.)

Parental

Ratings control allows you to set a limit, which prevents your children from viewing inappropriate materials. Playback will be stopped if the ratings exceed the levels you set, and it will require you to enter a password before playing back the disc.

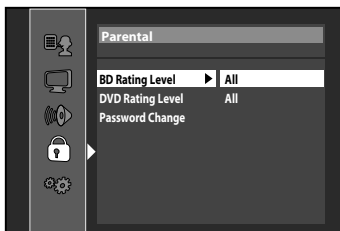

1. Use [**▲**/**▼**] to select , then press [OK].

2. Use [the Number buttons] to enter your 4-digit password.

For the first time use: Use [the Number buttons] to enter any 4-digit number (except for 4737), then press [OK]. That number will be used as the password from the second time. Record your password in case you forget it.

- If you forget the password, enter [4], [7], [3], [7]. The password will be cleared and rating level will be set to "All".

- While you input the password, press [CLEAR] to clear the number, then re-enter the password.

3. Proceed to A – C

A) BD Rating Level

1) Use [**▲**/**▼**] to select "BD Rating Level", then press [OK].

2) Use [**▲**/**▼**] to select your desired option, then press [OK].

"All": To release the limitation.

"Age Setting": To set the age limitation.

- After selecting "Age Setting", use [the Number buttons] to enter the age from 0 – 254. (e.g. for age 15, press [0], [1], [5])

3) Press [SETUP] to exit.

B) DVD Rating Level

1) Use [**▲**/**▼**] to select "DVD Rating Level", then press [OK].

2) Use [**▲**/**▼**] to select your desired level, then press [OK].

3) Press [SETUP] to exit.

RATING EXPLANATIONS

All:	Parental Control is inactive; all discs can be played back.
8 [Adult]:	DVD software of any grades (adult / general / children) can be played back.
7 [NC-17]:	No one under 18 admitted.
6 [R]:	Restricted; under 18 requires accompanying parent or adult guardian.
5 [PGR]:	Parental guidance recommended.
4 [PG-13]:	Unsuitable for children under 13.
3 [PG]:	Parental guidance suggested.
2 [G]:	General audience.
1 [Kid Safe]:	Suitable for children.

C) Password Change

1) Use [**▲**/**▼**] to select "Password Change", then press [OK].

2) Enter a new 4-digit password, then press [OK].

3) Press [SETUP] to exit.

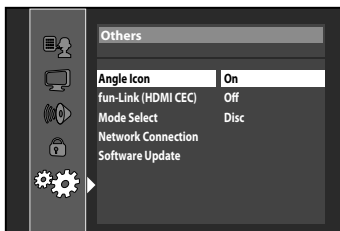

- To select the setting items and options, refer to “**Custom**” on page 30.
- “**Quick**” menu consists of the setting menus frequently used, and they are accompanied with **Q**.
- Settings with (*) are the default.

Setting items	Options / Descriptions
Angle Icon	On*: The angle icon appears on the TV screen when playing back the scene with various angle. Off: The angle icon disappears on the TV screen.
fun-Link (HDMI CEC) Sets whether to utilize the fun-Link (HDMI CEC) function. Refer to page 38.	On Off*
Mode Select Q Selects the media to playback.	Disc*: Select this when you play back a disc. SD Card: Select this when you play back an SD Memory Card. Network: Select this when you use Netflix / CinemaNow / Blockbuster / VUDU feature.

Setting items	Options / Descriptions						
Network Connection • Refer to page 39 for more information.	Connection Test			Perform a network connection test. After you change IP address or DNS setting, always perform this test.			
	Network Selection 	Wired*	Easy*			If you select "Easy", connection test will automatically start.	
Custom			IP Address Setting	Auto(DHCP)*		Set the IP address. In most cases, you can connect to the Internet without making any changes to the default setting.	
				Manual	IP Address		
					Subnet Mask		
			Default Gateway				
DNS Setting			Auto(DHCP)*				Set the DNS setting. In most cases, you can connect to the Internet without making any changes to the default setting.
			Manual	Primary DNS			
				Secondary DNS			
Proxy Setting			Do Not Use*				Set the proxy server. In most cases, you can connect to the Internet without using proxy server.
		Use	Proxy Address Proxy Port				
Connection Speed		Auto*				Set the connection speed. In most cases, you can connect to the Internet without making any changes to the default setting.	
		10BASE Half					
		10BASE Full					
		100BASE Half					
BD-Live Setting		Allow*				You can restrict Internet access when BD-Live functions are used.	
	Limited Allow						
	Prohibit						
	MAC Address				You can check the MAC address.		
Wireless	Wireless Router	Find wireless network Manually enter your SSID	WEP/WPA Authentication		Set up the connection to the wireless router and enter the WEP/WPA key required for wireless network connection.		
			Wireless Router Status		You can check the current status of the wireless router setting.		
	Advanced Settings	Easy*				If you select "Easy", connection test will automatically start.	
Custom		IP Address Setting		Set the IP address. In most cases, you can connect to the Internet without making any changes to the default setting.			
		DNS Setting		Set the DNS setting. In most cases, you can connect to the Internet without making any changes to the default setting.			
		Proxy Setting		Set the proxy server. In most cases, you can connect to the Internet without using proxy server.			
		BD-Live Setting		You can restrict Internet access when BD-Live functions are used.			
	MAC Address		You can check the MAC address.				
Disable	No*				Deactivate the network connection.		
	Yes						
Disclaimer				Displays the network service disclaimer.			

Setting items	Options / Descriptions	
Software Update Allows you to update this unit's firmware. Refer to page 43.	Current Version	Indicates the current firmware version.
	Disc Update	No*
	Allows you to update this unit's software using a disc.	Yes
	Network Update	No*
	You can update the software version by connecting this unit to the Internet.	Yes

fun-Link (HDMI CEC)

fun-Link (HDMI CEC) allows integrated system control over HDMI and is part of the HDMI standard. This function may not work properly depending on a device to be connected. When "fun-Link (HDMI CEC)" setting is set to "On", functions listed below will be available.

One Touch Play

When this unit is turned on, the TV also is turned on and the appropriate external input channel will be selected automatically. The appropriate external input channel can also be selected on your TV automatically when you press [▶ (play)], [◀◀ (skip)], [▶▶ (skip)], [the Number buttons], [DISPLAY], [TOP MENU], or [POP MENU / MENU] when the unit's power is on. (Buttons other than [▶ (play)] works only with discs inserted.)

Standby

When you press and hold [STANDBY/ON ⏻] for 2 seconds, it turns off the power of the TV first and then turns off the power of this unit also.

When the connected fun-Link (HDMI CEC) compatible display device is turned off, this unit may also turn off together.

System Information

Get & Set Menu Language

The unit recognizes the OSD language set for the TV and automatically sets the same language as the player menu language (OSD menu language) for this unit.

- This feature is available only when "Auto(XXXX)" is selected in "Player Menu" in the setup menu. (Refer to "Player Menu" on page 30.)

Network Connection

[SETUP] ⇒  ⇒ "Others" ⇒ "Network Connection"

Set up network connection settings in order to use BD-Live / Netflix / CinemaNow / Blockbuster / VUDU or network update function.

Connection Test

After you enable a network connection or change the network settings, always perform the connection test to check if the connection is correctly made.

1. In "Network Connection" menu, use [▲/▼] to select "Connection Test", then press [OK].

Connection test will start automatically and the test result will appear right after the connection test finishes.

- "Testing...": The test is in progress.
- "Pass": Connection test is successfully completed.
- "Fail": Connection test failed. Check the connection settings.

If the connection test passes, press [OK].

- Confirmation screen of the network selection will appear.

e.g.) Wired connection

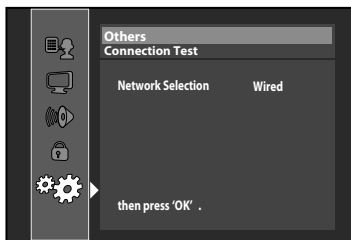

Press [OK] again to display the confirmation screen of network settings.

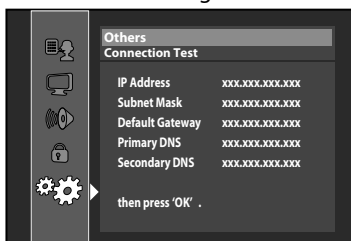

2. Press [OK], then press [SETUP] to exit.

Note

- If the connection test passes, you are ready to use BD-Live / Netflix / CinemaNow / Blockbuster / VUDU or network update function using the Internet without making any additional settings.

- If the connection test fails, you may need to change the MAC address settings on your router. You can check the MAC address of this unit on "Custom" screen. (Refer to "Custom (Wired)" on page 39.)
- When connecting this unit directly to a modem for the first time or connecting it to a modem which was previously connected to any other network device (e.g. a router, PC, etc.), you may have to power cycle the modem to reset the settings on the modem.
- "Connection Test" is not available when "Disable" is selected in "Network Connection".

Network Selection

■ Wired

Select "Wired" if you made a wired connection and set the setting to "Easy" (wired) or "Custom" (wired), in accordance with your network environment.

<Easy (Wired)>

Network settings are set to the following settings initially. (In most cases, you can connect to the Internet without making any changes to the default settings.)

- IP Address Setting Auto (DHCP)
- DNS Setting Auto (DHCP)
- Proxy Setting Do Not Use
- Connection Speed Auto
- BD-Live Setting Allow

If you want to set the network settings back to the default settings as above (except "BD-Live Setting"), follow the procedure below.

1. In "Network Connection" menu, use [▲/▼] to select "Network Selection", then press [OK].

2. Use [▲/▼] to select "Wired", then press [OK].

3. Use [▲/▼] to select "Easy", then press [OK].

- The unit will start the connection test automatically and the test result will appear right after the test finishes.

4. Press [OK] to activate the network settings and set the network connection automatically. Press [SETUP] to exit.

Note

- The setting of "BD-Live Setting" will not be set back to the default, even if you follow the procedure.

<Custom (Wired)>

In following cases, select "Custom" (wired) to set each setting as necessary.

- When connection test failed with the setting of "Easy" (wired).
- When instructed by your Internet service provider to make specific settings in accordance with your network environment.

To set the network setting to “Custom”(wired), follow the following procedure.

1. Follow steps 1 to 2 in “Easy (Wired)” on page 39.
2. Use [▲/▼] to select “Custom”, then press [OK].
 - Setting menu of “Custom”(wired) will be displayed.
3. Use [▲/▼] to highlight the item you want to set.
 - “MAC Address” is for viewing only and cannot be selected.
4. Find the instruction for the item from the following, and set the item.

IP Address Setting / DNS Setting

1. Press [OK] repeatedly to select the desired setting.

“Auto(DHCP)”: If your router has DHCP server function, select “Auto(DHCP)”.

“Manual”: If your router does not have DHCP server function, select “Manual”.

If you select “Manual”, follow the following instruction to set the IP address and DNS.

- a) Use [▲/▼] to select “IP Address”, “Subnet Mask” or “Default Gateway”, then press [OK]. IP address setting screen will appear. Enter IP address, subnet mask and default gateway with cursor buttons and number buttons.

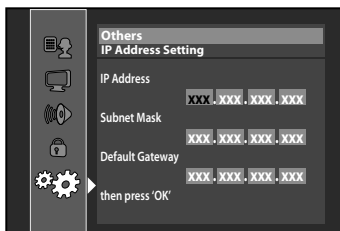

- Enter the IP address number after checking the specifications of your router.
- If the IP address is unknown, check the IP address of other devices. (e.g. PC connected via LAN cable) and assign a different number from those of other devices.

- b) After you enter all correctly, press [OK].
 - Confirmation message will appear. Select “Yes” to complete the settings.

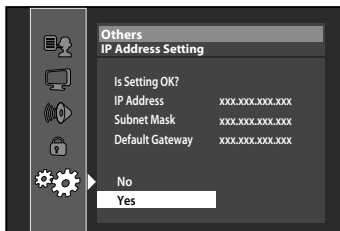

- c) Use [▲/▼] to select “Primary DNS” or “Secondary DNS”, then press [OK]. DNS setting screen will appear. Enter primary DNS and secondary DNS with cursor buttons and number buttons.

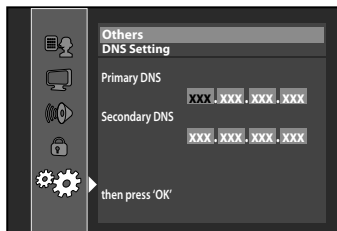

- Enter the DNS addresses provided by your Internet provider.
 - If the DNS address is unknown, check the DNS address of other devices (e.g. PC connected via LAN cable) and assign the same DNS address.
- d) After you enter all correctly, press [OK].
 - Confirmation message will appear. Select “Yes” to complete the settings.

2. Press [RETURN] to go back to the previous screen, or press [SETUP] to exit.

Note

- The range of input numbers is between 0 and 255.
- If you enter a number larger than 255, the number will automatically be 255.
- The manually entered addresses will be saved even if you change the setting to “Auto(DHCP)”.
- When you enter a wrong number, press [CLEAR] to cancel. (The number will be back to “0”)
- If you want to enter 1 or 2 digit number in one cell, press [▶] to move on to the next cell.
- If the entered IP address or the default gateway or primary DNS addresses is same as the default setting, IP address setting will be set to “Auto(DHCP)”. (The manually entered number will be saved.)
- When IP address setting is set to “Manual”, the setting of DNS setting will automatically be “Manual” and when IP address setting is set to “Auto(DHCP)”, you can set either “Auto(DHCP)” or “Manual” for DNS setting.

Proxy Setting

1. Press [OK] repeatedly to select the desired setting.

- For default settings, select “Do Not Use”.
- If you need to change the proxy setting as instructed by your Internet service provider to set the designated proxy address and port, select “Use”.

If you select “Use”, follow the following instructions to set the proxy address and proxy port.

- a) Use [▲/▼] to select “Proxy Address”, then press [OK]. Proxy address setting screen will appear. Enter proxy address.
- The keyboard screen will appear.



[▲/▼/◀/▶]:	Move the highlight.
[the Number buttons]:	Enter number.
[OK]:	Enter the highlighted number/word.
[RED]:	Clear the entered number or word.
[GREEN]:	Clear all the entered numbers or words.
[BLUE]:	Switch between abc ? ABC ? @!?
[YELLOW]:	Set the entered number or word.

- b) After you enter proxy address correctly, press [YELLOW].
- Confirmation message will appear. Select “Yes” to complete the settings.

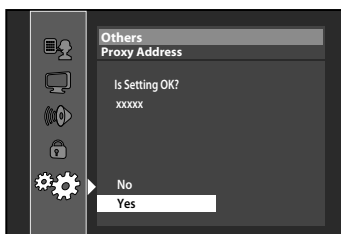

- c) Use [▲/▼] to select “Proxy Port”, then press [OK]. Proxy port setting screen will appear. Enter proxy port number with number buttons.

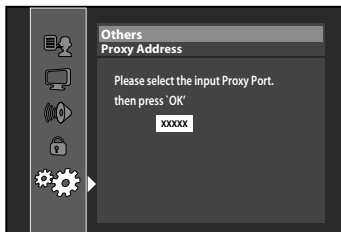

- d) After you enter proxy port correctly, press [OK].
2. Press [RETURN] to go back to the previous screen, or press [SETUP] to exit.

Note

- The range of input numbers for the port number is between 0 and 65535. (If you enter a number larger than 65535, it will be regarded as 65535.)

- For proxy port, certain ports might be closed, blocked or unusable depending on your network environment.

Connection Speed

You can set connection speed as your preference. (The default setting is “Auto”.)

1. Press [OK] to show the options for “Connection Speed”.
2. Use [▲/▼] to select the desired setting, then press [OK].

“Auto”:

Set the appropriate connection speed automatically, in accordance with your network environment.

“10BASE Half”:

Set the connection speed to “10BASE Half”.

“10BASE Full”:

Set the connection speed to “10BASE Full”.

“100BASE Half”:

Set the connection speed to “100BASE Half”.

“100BASE Full”:

Set the connection speed to “100BASE Full”.

3. Press [RETURN] to go back to the previous screen, or press [SETUP] to exit.

Note

- Choose a connection speed in accordance with your network environment.
- The network connection may be disabled depending on the device, when the settings are changed.

BD-Live Setting

You can limit Internet access for BD-Live discs. (The default setting is “Allow”.)

1. Press [OK] to show the options for “BD-Live Setting”.
2. Use [▲/▼] to select the desired setting, then press [OK].

“Allow”:

Internet access is permitted for all BD-Live contents.

“Limited Allow”:

Internet access is permitted only for BD-Live contents which have content owner certificates. Internet access without the certificates is prohibited.

“Prohibit”:

Internet access is prohibited for all BD-Live contents.

3. Press [RETURN] to go back to the previous screen, or press [SETUP] to exit.

MAC Address

You can check the MAC address of this unit. “MAC Address” is for viewing only.

■ Wireless

If you connect this unit to the network wirelessly, select “Wireless” and set up necessary settings.

<Wireless Router>

In order to use a wireless network, you must set up the connection to the wireless router.

Find wireless network

Search for wireless networks automatically and select the wireless network name (SSID) from the list.

1. In “Network Connection” menu, use [▲/▼] to select “Network Selection”, then press [OK].
2. Use [▲/▼] to select “Wireless”, then press [OK].
3. Use [▲/▼] to select “Wireless Router”, then press [OK].
4. Use [▲/▼] to select “Find wireless network”, then press [OK].
 - This unit will start searching for wireless networks automatically.
5. The list of wireless networks will be displayed. Use [▲/▼] to select the appropriate wireless network name (SSID), then press [OK].
 - This unit will start searching for the authentication setting of the selected wireless network automatically.

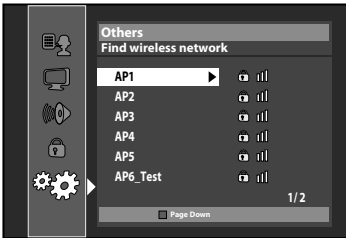

If the unit finds the authentication setting of the selected wireless network, skip to step 7. If the unit fails to find the authentication setting automatically, proceed to step 6 to select it manually.

6. Use [▲/▼] to select the authentication setting of the selected wireless network, then press [OK].

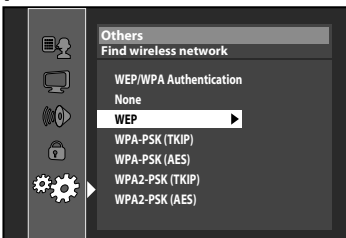

- For a wireless network with authentication setting, select the authentication setting, according to the security type of the wireless network.
- For a wireless network without authentication setting, select “None”.

“None”:

Set the authentication setting to “None”.

“WEP”:

Set the authentication setting to “WEP”.

“WPA-PSK (TKIP)”:

Set the authentication setting to “WPA-PSK (TKIP)”.

“WPA-PSK (AES)”:

Set the authentication setting to “WPA-PSK (AES)”.

“WPA2-PSK (TKIP)”:

Set the authentication setting to “WPA2-PSK (TKIP)”.

“WPA2-PSK (AES)”:

Set the authentication setting to “WPA2-PSK (AES)”.

7. “WEP/WPA Key” entry screen will appear.

Enter the WEP/WPA key of the selected wireless network using cursor buttons, number buttons and color key, then press [YELLOW].

- Confirmation message will appear. Select “Yes” to complete the settings.

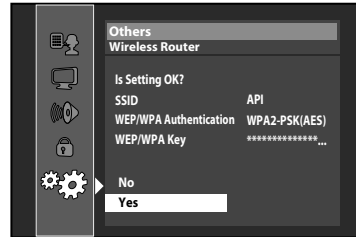

8. Following screen will appear. Use [▲/▼] to select “Yes”, then press [OK] to go to “Advanced Settings”.

- For further operation, refer to “Advanced Settings” on page 43.

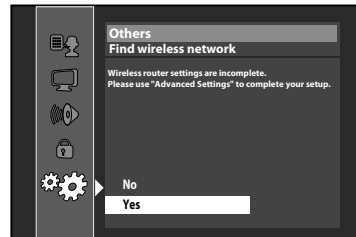

9. Press [SETUP] to exit.

Note

- For a wireless network with authentication setting, key icon appears to the right hand of the wireless network name (SSID).
- Signal icon shows the strength of the signal.
- WEP/WPA key appears as asterisks on the confirmation screen.

Manually enter your SSID

Set up the connection to the wireless router manually by entering the wireless network name (SSID).

1. Follow steps 1 to 3 in “Find wireless network” on page 42.

2. Use [▲/▼] to select “Manually enter your SSID”, then press [OK].

- Wireless Router Name (SSID) entry screen will appear. Enter the wireless network name (SSID) using cursor buttons, number buttons and color key, then press [YELLOW].



- List of authentication settings will appear.
3. Follow steps 6 to 9 in “Find wireless network” on page 42.

Wireless Router Status

You can check the current status of “Wireless Router” setting.

1. Follow steps 1 to 3 in “Find wireless network” on page 42.

2. Use [▲/▼] to select “Wireless Router Status”, then press [OK].

- The list of current wireless router settings, and the confirmation message will appear. Select “Yes” to complete the settings.

3. Press [RETURN] to go back to the previous screen, or press [SETUP] to exit.

<Advanced Settings>

After you set up the “Wireless Router” setting, set the network setting to “Easy” (wireless) or “Custom”(wireless).

Easy (wireless)

To set the network setting to “Easy”(wireless), follow the following procedure. For details of this setting, refer to “Easy (Wired)” on page 39.

- If you select “Yes” in step 7 of “Find wireless network” on page 42, skip to step 3.

1. Follow steps 1 to 2 in “Find wireless network” on page 42.

2. Use [▲/▼] to select “Advanced Settings”, then press [OK].

3. Use [▲/▼] to select “Easy”; then press [OK].

Custom (wireless)

To set the network setting to “Custom”(wireless), follow the following procedure.

- If you select “Yes” in step 7 of “Find wireless network” on page 42, skip to step 3.

1. Follow steps 1 to 2 in “Find wireless network” on page 42.

2. Use [▲/▼] to select “Advanced Settings”, then press [OK].

3. Use [▲/▼] to select “Custom”, then press [OK].

- For details of each setting, refer to following pages.

“IP Address Setting” / “DNS Setting”:

Refer to “IP Address Setting / DNS Setting” on page 40.

“Proxy Setting”:

Refer to “Proxy Setting” on page 40.

“BD-Live Setting”:

Refer to “BD-Live Setting” on page 41.

“MAC Address”:

Refer to “MAC Address” on page 41.

Note

- You cannot select “Advanced Settings” if “Wireless Router” setting is not completed.

■ Disable

Deactivate all the network connection and settings.

1. In “Network Connection” menu, use [▲/▼] to select “Network Selection”, then press [OK].

2. Use [▲/▼] to select “Disable”, then press [OK].

3. Press [RETURN] to go back to the previous screen, or press [SETUP] to exit.

Note

- The network connection can be reactivated by setting network connection to “Wired” or “Wireless”.

Software Update

[SETUP]⇒[?/!]&⇒“Other”⇒“Software Update”

This unit lets you update the software yourself using a software update disc.

To update the software, you must first download the latest version software to a disc, then execute “Software Update”.

Current Version

You can confirm the current software version.

1. In “Software Update” menu, use [▲/▼] to select “Current Version”, then press [OK].

2. Press [OK] or [RETURN] to exit.

■ Disc Update

1. Prepare a software update disc:

Access www.sylvaniamconsumerelectronics.com, and download the latest version software to a blank disc by following the directions described on the site.

- Use a blank disc and download one software per disc.
- For more details on how to download the software, please refer to the site.

2. In “Software Update” menu, use [▲/▼] to select “Disc Update”, then press [OK].

3. Use [▲/▼] to select “Yes”, then press [OK].
 - Disc tray will open automatically.

4. Insert the software update disc obtained at step 1.

5. After completing loading disc, confirmation message will appear. Select “Yes” and press [OK] to start updating.

6. After the disc update finishes, this unit will restart and eject the disc.

The indicators show the progress status...

(Success) PLAY indicator lights up.



(Error)* PLAY and STANDBY/ON indicators flash.



* If the indicator shows Error...

- 1) Unplug the AC power cord for about 10 seconds, re-plug AC power cord and then turn the unit on.
- 2) Confirm the current software version.
- 3) If the software version is updated, the software update has succeeded. If not, please try again.

Note

- Please do not unplug the AC power cord while updating the software.
- All settings will remain the same even if you update the software version.
- The version of Netflix will also be updated if newer version of Netflix is available when updating the software.

■ Network Update

You can update the software by connecting the unit to the Internet.

1. In “Software Update” menu, use [▲/▼] to select “Network Update”, then press [OK].
2. Use [▲/▼] to select “Yes”, then press [OK].
 - This unit will then start checking for the latest software version.
3. Confirmation message will appear. Use [◀/▶] to select “Yes”, then press [OK].
 - The unit will start downloading the latest software version.
4. When the download completes, confirmation message will appear. Press [OK].
 - The unit will start updating the software version.
 - It may take a while to complete the updating.
5. After updating finishes, this unit will restart and open the disc tray automatically.

Note

- In order to update the software via the Internet, you must connect the unit to the Internet and set up necessary settings.
- For network connection, refer to “Connection to the Network” on page 12.
- For network setup, refer to “Network Connection” on page 39.
- Please do not unplug the AC power cord or LAN cable while executing the “Network Update”.
- All settings will remain the same even if you update the software version.
- The disc tray will open automatically after updating finishes. This is not a malfunction.

- The version of Netflix will also be updated if newer version of Netflix is available when updating the software.

Initialize

Menus to reset player settings, format SD card, clear erased BD-ROM data or network settings, and deactivate VUDU.

1. In stop mode, press [SETUP].
2. Use [▲/▼] to select , then press [OK].
3. Use [▲/▼] to select a desired option, then press [OK].

“Setup”:

Resets the setup menu to the default. The setting for “Parental”, “Network Connection” and “Mode Select” will not be reset.

“Format SD Card”

(Available only when an SD Memory Card is inserted.):

Initializes the SD Memory Card. After confirmation message appears, use [▲/▼] to select “Yes”, then press [OK].

“Erase Saved BD-ROM Data (Player)”:

Clears the data saved for the BD-ROM contents, such as BD-ROM game scores, from this player.

“Erase Saved BD-ROM Data (SD Card)”

(Available only when an SD Memory Card is inserted.):

Clears the supplemental data for the BD-ROM playback, such as subtitle data, from the SD Memory Card.

“Network Settings”:

Resets the network setting to the default.

“Netflix Deactivate”:

Deactivates the connection to Netflix.

“Vudu Deactivate”:

Deactivates the connection to VUDU.

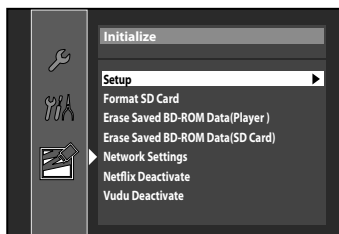

4. Confirmation message will appear. Use [▲/▼] to select “Yes”, then press [OK].
 - Press [OK] again to complete the settings.
5. Press [SETUP] to exit.

Note

- Do not remove the SD Memory Card while executing the “Format SD Card” or the “Erase Saved BD-ROM Data (SD Card)”. It damages the card.

OTHERS

Troubleshooting

If the unit does not perform properly when operated as instructed in this manual, check the unit, consulting the following checklist.

Problem	Solution
No power.	<ul style="list-style-type: none"> - Check if the AC cord is properly connected. - Unplug the AC cord once, and wait for 5-10 seconds and then plug it in again.
No sound or picture.	<ul style="list-style-type: none"> - Check if the connected TV is turned on. - Check if the connections are made securely and correctly. - Check whether the connected TV or other device supports HDCP. (This unit will not output a video signal unless the other device supports HDCP.) - Check whether the output format of this unit (HDMI FORMAT) matches the supported input format of other connected device.
No audio / video signal on the display device via HDMI cable.	<ul style="list-style-type: none"> - If the unit is connected to the unauthorized display device with an HDMI cable, the audio / video signal may not be output. - Perform an HDMI cable hotplug, wherein you disconnect the HDMI cable from the TV and this unit and then reconnect it to both the devices while they are powered on. - Ensure that your HDMI cable is certified.
Distorted picture.	<ul style="list-style-type: none"> - Sometimes a small amount of picture distortion may appear. This is not a malfunction. - Connect this unit directly to the TV. If the audio / video cables are connected to a VCR, pictures may be distorted due to the copy right protection system.
Completely distorted picture or black / white picture with BD / DVD.	<ul style="list-style-type: none"> - Make sure the disc is compatible with this unit.
No sound or distorted sound.	<ul style="list-style-type: none"> - Adjust the volume. - Check if speakers are connected correctly. - Check the HDMI connections. - Check the settings in "Audio" menu.
Picture freezes momentarily during playback.	<ul style="list-style-type: none"> - Check the disc for fingerprints / scratches and clean with a soft cloth wiping from center to edge. - Clean the disc.
Disc cannot be played back.	<ul style="list-style-type: none"> - Clean the disc. - Ensure the disc label is facing up. - Check if the disc is defective by trying another disc. - Cancel the ratings control or change the control level. - Insert a correct disc that can be played back on this unit.
SD Memory Card cannot be read.	<ul style="list-style-type: none"> - The format of the card does not match that accepted by this unit or the card is not compatible.
No return to start-up screen when disc is removed.	<ul style="list-style-type: none"> - Reset this unit by turning it off, then on again.
The unit does not respond to the remote control.	<ul style="list-style-type: none"> - Aim the remote control directly at infrared sensor window on the front panel. - Reduce the distance to infrared sensor window. - Replace the batteries in the remote control. - Re-insert the batteries with their polarities (+ / - signs) as indicated.
Buttons do not work or the unit stops responding.	<ul style="list-style-type: none"> - To completely reset the unit, press and hold [⏻ STANDBY/ON] on the front panel for 10 seconds to shut down the unit or unplug the AC cord from the AC outlet for 5-10 seconds.
The unit does not respond to some operating commands during playback.	<ul style="list-style-type: none"> - Operations may not be permitted by the disc. Refer to the instructions of the disc.

Problem	Solution
The unit cannot read BD / DVD/ CD.	<ul style="list-style-type: none"> - Condensation? (Let sit 1 or 2 hours) - Check if the disc is compatible with this unit.(Refer to page 14.) - Wipe the dirt off the disc or replace the disc.
Angle does not switch.	- The angle cannot be switched for BD / DVD which do not contain multiple angles. In some cases multiple angles are only recorded for specific scenes.
Playback does not start when the title is selected.	- Check the settings in "Parental" menu.
The password for rating level has been forgotten.	- Enter the default password "4737", then your forgotten password will be cleared.
Cannot connect to the network.	<ul style="list-style-type: none"> - Check if the LAN cable connection is properly made. - Turn on the modem or broadband router. - Check the network setting. - Check if the broadband router and/or modem is correctly connected. - Check the "BD-Live Setting". - When connecting directly to a modem via a LAN cable, you might need to power cycle the modem to reset settings on the modem.
Cannot use the wireless connection.	- Once you have activated the wireless connection please wait 30 seconds for the connection to be established after turning on the unit, before trying to access network features such as BD-Live / Netflix / CinemaNow / Blockbuster / VUDU.
Cannot connect to the network while my PC is connected to the network.	- Check the content of your Internet service contract to see if your Internet service provider prevents multiple terminals connecting at the same time.
The capacity of the SD card decreased.	- Data may be written to the SD card when a BD-video that supports the virtual package is used and an SD card is in the slot.
Cannot use the BD-Live function or download of data does not perform properly.	<ul style="list-style-type: none"> - Insert an SD card with enough capacity (1GB or more). - Check if an SD card is correctly inserted. - Make sure the write-protect switch on the SD card is not enabled.
Cannot play back BD-video (BD-ROM Profile 2.0).	<ul style="list-style-type: none"> - Insert an SD card(1GB or more) which is formatted on this unit. - Some discs with BD-Live function require memory when playing back the content. - Do not remove the card during playback. - Make sure the write-protect switch on the SD card is not enabled.
Cannot use Netflix feature.	<ul style="list-style-type: none"> - Netflix is available only in the United States. - Check if the network connection is properly made. - Visit netflix.com/sylvania on your PC and become a Netflix member.
Cannot add movies or TV episodes to the instant Queue.	<ul style="list-style-type: none"> - Visit netflix.com on your PC. - Adding movies or TV episodes on this unit is not available.
Even though the speed of the Internet connection improves during playback, the picture quality of Netflix streaming movie does not improve.	<ul style="list-style-type: none"> - The picture quality does not change during playback. - The picture quality differs depending on the speed of Internet connection at the time of loading.
The picture quality of streaming movie (Netflix / CinemaNow / Blockbuster / VUDU) is poor.	- Check the speed of your Internet connection. You need speeds of at least 8 Mbps to this player for high quality uninterrupted playback.
Streaming movie (Netflix / CinemaNow / Blockbuster / VUDU) often stops or starts buffering during playback.	- Contact your Internet service provider to troubleshoot your Internet connection for speed and line quality. Consistent line quality and speed are very important for Internet video playback.
Cannot use CinemaNow / Blockbuster feature.	<ul style="list-style-type: none"> - Check if the network connection is properly made. - Visit www.cinemanow.com/Login (CinemaNow) or www.blockbuster.com/auth/login (Blockbuster) on your PC and create an account.
Cannot use VUDU feature.	- Check if the network connection is properly made.

Problem	Solution
Cannot rent or buy movies / TV episodes on VUDU.	- You need to activate the VUDU account. (Refer to page 28) - Log into your account at http://my.vudu.com and check your payment information.

Note

- Some functions are not available in specific modes, but this is not a malfunction. Read the description in this manual for details on correct operations.
- Some functions are prohibited on some discs.

Language Code List

Language	Code	Language	Code	Language	Code	Language	Code
A-B		French [FRE]	5264	Macedonian	5957	Siswat	6565
Abkhazian	4748	Frisian	5271	Malagasy	5953	Slovak [SLO]	6557
Afar	4747	Galician	5358	Malay	5965	Slovenian	6558
Afrikaans	4752	Georgian	5747	Malayalam	5958	Somali	6561
Albanian	6563	German [GER]	5051	Maltese	5966	Spanish [SPA]	5165
Amharic	4759	Greek [GRE]	5158	Maori	5955	Sundanese	6567
Arabic	4764	Greenlandic	5758	Marathi	5964	Swahili	6569
Armenian	5471	Guarani	5360	Moldavian	5961	Swedish [SWE]	65681
Assamese	4765	Gujarati	5367	Mongolian	5960	T	
Aymara	4771	Hausa	5447	Nauru	6047	Tagalog	6658
Azerbaijani	4772	Hebrew	5569	Nepali	6051	Tajik	6653
Bashkir	4847	Hindi	5455	Norwegian [NOR]	6061	Tamil	6647
Basque	5167	Hungarian [HUN]	5467	O-R		Tatar	6666
Bengali;Bangla	4860	I-K		Occitan	6149	Telugu	6651
Bhutani	5072	Icelandic [ICE]	5565	Oriya	6164	Thai	6654
Bihari	4854	Indonesian	5560	Oromo (Afan)	6159	Tibetan	4861
Bislama	4855	Interlingua	5547	Panjabi	6247	Tigrinya	6655
Breton	4864	Interlingue	5551	Pashto;Pushto	6265	Tonga	6661
Bulgarian [BUL]	4853	Inupiak	5557	Persian	5247	Tsonga	6665
Burmese	5971	Irish [IRI]	5347	Polish [POL]	6258	Turkish [TUR]	6664
Byelorussian	4851	Italian [ITA]	5566	Portuguese[POR]	6266	Turkmen	6657
C-E		Japanese [JPN]	5647	Quechua	6367	Twi	6669
Cambodian	5759	Javanese	5669	Rhaeto-Romance	6459	U-Z	
Catalan	4947	Kannada	5760	Romanian [RUM]	6461	Ukrainian	6757
Chinese [CHI]	7254	Kashmiri	5765	Russian [RUS]	6467	Urdu	6764
Corsican	4961	Kazakh	5757	S		Uzbek	6772
Croatian	5464	Kinyarwanda	6469	Samoan	6559	Vietnamese	6855
Czech [CZE]	4965	Kirghiz	5771	Sangho	6553	Volapuk	6861
Danish [DAN]	5047	Kirundi	6460	Sanskrit	6547	Welsh	4971
Dutch [DUT]	6058	Korean [KOR]	5761	Scots Gaelic	5350	Wolof	6961
English [ENG]	5160	Kurdish	5767	Serbian	6564	Xhosa	7054
Esperanto	5161	L-N		Serbo-Croatian	6554	Yiddish	5655
Estonian	5166	Laothian	5861	Sesotho	6566	Yoruba	7161
F-H		Latin	5847	Setswana	6660	Zulu	7267
Faroese	5261	Latvian;Lettish	5868	Shona	6560		
Fiji	5256	Lingala	5860	Sindhi	6550		
Finnish [FIN]	5255	Lithuanian	5866	Singhalese	6555		

Note

- If you choose a language that has a 3-letter-language code (written in bracket), the code will be displayed every time you change the audio setting on page 24 or subtitle language setting on page 23. If you choose any other languages, “---” will be displayed instead.

Servicing

- Please refer to relevant topics on “Troubleshooting” on page 45 before returning the product.
- If this unit becomes inoperative, do not try to correct the problem by yourself. There are no user-serviceable parts inside. Turn the unit to the standby mode, unplug the power plug, and please contact 1-800-968-3429 or visit : www.sylvaniacustomerelectronics.com
www.funaiservice.com/

Specifications

General

Signal system	NTSC color
Power requirements	120 V AC, 60 Hz
Power consumption	16 W (standby: 0.5 W)
Dimensions (width x height x depth)	14.2 x 2.0 x 8.5 inches (360 x 50 x 214.5mm)
Weight	4.04 lbs. (1.83 kg)
Operating temperature	41°F (5°C) to 104°F (40°C)
Operating humidity	Less than 80 % (no condensation)

Terminals (Rear)

Video output (RCA jack x 1)	1 Vp-p (75Ω)
HDMI output (HDMI jack x 1)	Video: 480p, 720p, 1080i, 1080p, 1080p24 / Audio
Audio output (Analog) (RCA jack x 2)	L/R: 2 Vrms (output impedance: more than 1kΩ)
Audio output (Digital) (RCA jack x 1)	500 mVp-p (75Ω)
LAN terminal	10BASE-T/100BASE-TX
Wireless LAN	IEEE 802.11 b/g/n

Note

- The specifications and design of this product are subject to change without notice.

NETWORK SERVICE DISCLAIMER

Network Service Disclaimer

Content and services made available through this product are transmitted by third parties by means of networks and transmission facilities over which Company has no control and third party services may be terminated or interrupted at any time, and Company makes no representation or warranty that any content or service will remain available for any period of time. Without limiting the generality of this disclaimer, Company expressly disclaims any responsibility for any interruption or suspension of any content or service made available through this product. Company is not responsible for customer service related to the content and services. Any question or request for service relating to the content or services should be made directly to the respective content and service providers.

THIRD PARTY CONTENT AND SERVICES MADE AVAILABLE THROUGH THIS PRODUCT ARE PROVIDED "AS IS." COMPANY DOES NOT WARRANT CONTENT OR SERVICES SO PROVIDED, FOR ANY PURPOSE WHATSOEVER. COMPANY EXPRESSLY DISCLAIMS ANY WARRANTIES, EXPRESS OR IMPLIED INCLUDING WITHOUT LIMITATION, WARRANTIES OF MERCHANTABILITY OR FITNESS FOR A PARTICULAR PURPOSE, ACCURACY, VALIDITY, TIMELINESS, LEGALITY, SUITABILITY, OR QUALITY OF ANY CONTENT OR SERVICE MADE AVAILABLE THROUGH THIS PRODUCT.

IN NO EVENT SHALL COMPANY BE LIABLE FOR, ANY DAMAGES, WHETHER ARISING IN CONTRACT OR TORT, INCLUDING WITHOUT LIMITATION, ANY DIRECT, INDIRECT, INCIDENTAL, SPECIAL OR CONSEQUENTIAL DAMAGES, LOST PROFITS, ATTORNEY FEES, EXPENSES, OR ANY OTHER DAMAGES ARISING OUT OF, OR IN CONNECTION WITH, ANY CONTENT (OR ANY INFORMATION CONTAINED THEREIN) OR SERVICE PROVIDED TO THE USER OR ANY THIRD PARTY, EVEN IF ADVISED OF THE POSSIBILITY OF SUCH DAMAGES.

All content and services accessible through this product belong to third parties and are protected by copyright, patent, trademark and/or other intellectual property rights. Such content and services are provided solely for the User's personal noncommercial use. User may not use any content or services in a manner that has not been authorized by the content owner or service provider. Without limiting the foregoing, unless expressly authorized by the applicable content owner or service provider, you may not modify, copy, republish, upload, post, transmit, translate, sell, create derivative works, exploit, or distribute in any manner or medium any content or services made available through this product.

Discos Reproducibles

Este aparato es compatible con la reproducción de los siguientes discos y archivos.

Discos y Archivos Reproducibles

Discos reproducibles
Discos Blu-ray
- BD-vídeo (capa simple / doble)
- BD-RE ver. 2.1 (capa simple / doble) (Grabado en formato BDMV)
- BD-R ver. 1.1 / 1.2 / 1.3 (capa simple / doble) (Grabado en formato BDMV) (Los discos no cerrados pueden no reproducirse.)
DVD-vídeo
DVD-RW
DVD-R
CD-DA (CD de sonido)
CD-RW
CD-R
KODAK Picture CD
DTS-CD

Archivos reproducibles	Soportes
AVCHD	DVD-RW/-R Tarjeta de memoria SD (incluido SDHC), Tarjeta miniSD, Tarjeta microSD
Windows Media™ Audio	BD-RW/-R
JPEG	DVD-RW/-R CD-RW/-R Tarjeta de memoria SD (incluido SDHC), Tarjeta miniSD, Tarjeta microSD

Tarjetas legibles	Archivos / datos reproducibles
Tarjeta de memoria SD (8 MB - 2 GB)	AVCHD, Windows Media™ Audio, JPEG, comentario en imágenes, subtítulos u otros extras del BD-ROM ver.2(profile 2.0 / profile 1.1)
Tarjeta de memoria SDHC (4 GB - 8 GB)	
Tarjeta miniSD (8 MB - 2 GB)	
Tarjeta microSD (8 MB - 2 GB)	

Esta unidad se ha diseñado para reproducir BD-vídeo con región "A" y DVD-vídeo con región "1" o "ALL". No podrá reproducir BD-vídeo o DVD-vídeo que estén tituladas para otras regiones. Busque los símbolos de su BD-vídeo o DVD-vídeo.

Si estos símbolos de regiones no aparecen en su BD-vídeo o DVD-vídeo, no puede reproducir el disco en esta unidad. El número o letra dentro del globo se refiere a la región del mundo. Un BD-vídeo o DVD-vídeo etiquetado para una región específica solamente puede reproducirse en unidades que tengan el mismo código de región.

Encontrar el Canal de Vídeo en su Televisor

Una vez finalizadas todas las conexiones, debe localizar el canal de vídeo correspondiente en su televisor (canal de entrada externa).

1. Una vez que haya realizado todas las conexiones correspondientes, pulse **[STANDBY/ON]** para encender la unidad.
2. Encienda su televisor.
3. Pulse el botón del mando a distancia del televisor que da acceso al canal de entrada externa. Puede tener el nombre de "SOURCE", "AV" o "SELECT" (consulte el manual del usuario de su televisor).

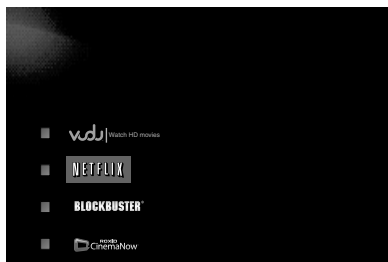

Ajusta el idioma para el menú del reproductor

1. En modo detención, pulse **[SETUP]**.
2. Utilice **[▲/▼]** para seleccionar **[?]** y después pulse **[OK]**.
3. Utilice **[▲/▼]** para seleccionar "Player Menu" y después pulse **[OK]**.

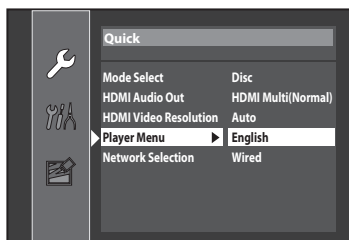

4. Utilice **[▲/▼]** para seleccionar su idioma deseado, y luego presione **[OK]**.

5. Pulse **[SETUP]** para salir.

Reproducción Directa

1. Presione [OPEN/CLOSE ▲] para abrir la bandeja de discos e insertar su disco con el rótulo apuntando hacia arriba. Presione de nuevo [OPEN/CLOSE ▲] para cerrar la bandeja de discos.

- Asegúrese de que el disco sea compatible con este aparato.

2. Es posible que la reproducción comience automáticamente.

- De lo contrario, pulse ► (reproducir)].

Para pausar la reproducción:
Pulse || (pausar)].

Para retomar la reproducción normal:

Pulse ► (reproducir)].

Para detener la reproducción:

Pulse ■ (detener)].

Reproducción se encuentra en el modo

Reanudar-Detención.

3. Para detener momentáneamente la reproducción presione [STOP ■] una vez.

SYLVANIA

LIMITED WARRANTY

FUNAI CORP. will repair this product, free of charge in the USA in the event of defect in materials or workmanship as follows:

DURATION:

PARTS: FUNAI CORP. will provide parts to replace defective parts without charge for one (1) year from the date of original retail purchase. Certain parts are excluded from this warranty.

LABOR: FUNAI CORP. will provide the labor without charge for a period of ninety (90) days from the date of original retail purchase.

LIMITS AND EXCLUSIONS:

THIS WARRANTY IS EXTENDED ONLY TO THE ORIGINAL RETAIL PURCHASER. A PURCHASE RECEIPT OR OTHER PROOF OF ORIGINAL RETAIL PURCHASE WILL BE REQUIRED TOGETHER WITH THE PRODUCT TO OBTAIN SERVICE UNDER THIS WARRANTY.

This warranty shall not be extended to any other person or transferee.

This warranty is void and of no effect if any serial numbers on the product are altered, replaced, defaced, missing or if service was attempted by an unauthorized service center. This limited warranty does not apply to any product not purchased and used in the United States.

This warranty only covers failures due to defects in material or workmanship which occur during normal use. It does not cover damage which occurs in shipment, or failures which are caused by repairs, alterations or products not supplied by FUNAI CORP., or damage, which results from accident, misuse, abuse, mishandling, misapplication, alteration, faulty installation, improper maintenance, commercial use such as hotel, rental or office use of this product, or damage which results from fire, flood, lightning or other acts of God.

THIS WARRANTY DOES NOT COVER PACKING MATERIALS, ANY ACCESSORIES (EXCEPT REMOTE CONTROL), ANY COSMETIC PARTS, COMPLETE ASSEMBLY PARTS, DEMO OR FLOOR MODELS. FUNAI CORP. AND ITS REPRESENTATIVES OR AGENTS SHALL IN NO EVENT BE LIABLE FOR ANY GENERAL, INDIRECT OR CONSEQUENTIAL DAMAGES ARISING OUT OF OR OCCASIONED BY THE USE OF OR THE INABILITY TO USE THIS PRODUCT. THIS WARRANTY IS MADE IN LIEU OF ALL OTHER WARRANTIES, EXPRESS OR IMPLIED, AND OF ALL OTHER LIABILITIES ON THE PART OF FUNAI, ALL OTHER WARRANTIES INCLUDING THE WARRANTY OF MERCHANTABILITY AND FITNESS FOR A PARTICULAR PURPOSE, ARE HEREBY DISCLAIMED BY FUNAI AND ITS REPRESENTATIVES IN THE UNITED STATES.

ALL WARRANTY INSPECTIONS AND REPAIRS MUST BE PERFORMED BY AN AUTHORIZED SERVICE CENTER.

THIS WARRANTY IS ONLY VALID WHEN THE UNIT IS CARRIED-IN TO AN AUTHORIZED SERVICE CENTER. THE PRODUCT MUST BE ACCOMPANIED BY A COPY OF THE ORIGINAL RETAIL PURCHASE RECEIPT. IF NO PROOF OF PURCHASE IS ATTACHED, THE WARRANTY WILL NOT BE HONORED AND REPAIR COSTS WILL BE CHARGED.

IMPORTANT:

THIS LIMITED WARRANTY GIVES YOU SPECIFIC LEGAL RIGHTS. YOU MAY HAVE OTHER RIGHTS THAT VARY FROM STATE TO STATE. IF, AT ANY TIME DURING THE WARRANTY PERIOD, YOU ARE UNABLE TO OBTAIN SATISFACTION WITH THE REPAIR OF THIS PRODUCT, PLEASE CONTACT FUNAI CORP.

ATTENTION:

FUNAI CORP. RESERVES THE RIGHT TO MODIFY ANY DESIGN OF THIS PRODUCT WITHOUT PRIOR NOTICE.

WARRANTY STATEMENT REGARDING NON AUTHORIZED REPAIRS:

To obtain warranty service, you must take the product, or deliver the product freight prepaid, in either its original packaging or packaging affording an equal degree of protection, to any AUTHORIZED SERVICE CENTER. FUNAI CORP. will not reimburse you for any service done by unauthorized service providers without prior written approval.

To locate your nearest AUTHORIZED SERVICE CENTER or for general service inquiries, please contact us at:

FUNAI SERVICE CORPORATION

Tel: 1-800-968-3429

www.sylvaniaconsumerelectronics.com

www.funaiservice.com/

2200 Spiegel Drive Groveport, OH 43125

