

SYLVANIA

15" Digital / Analog LCD TV built-in DVD Player

Owner's Manual

LD155SC8

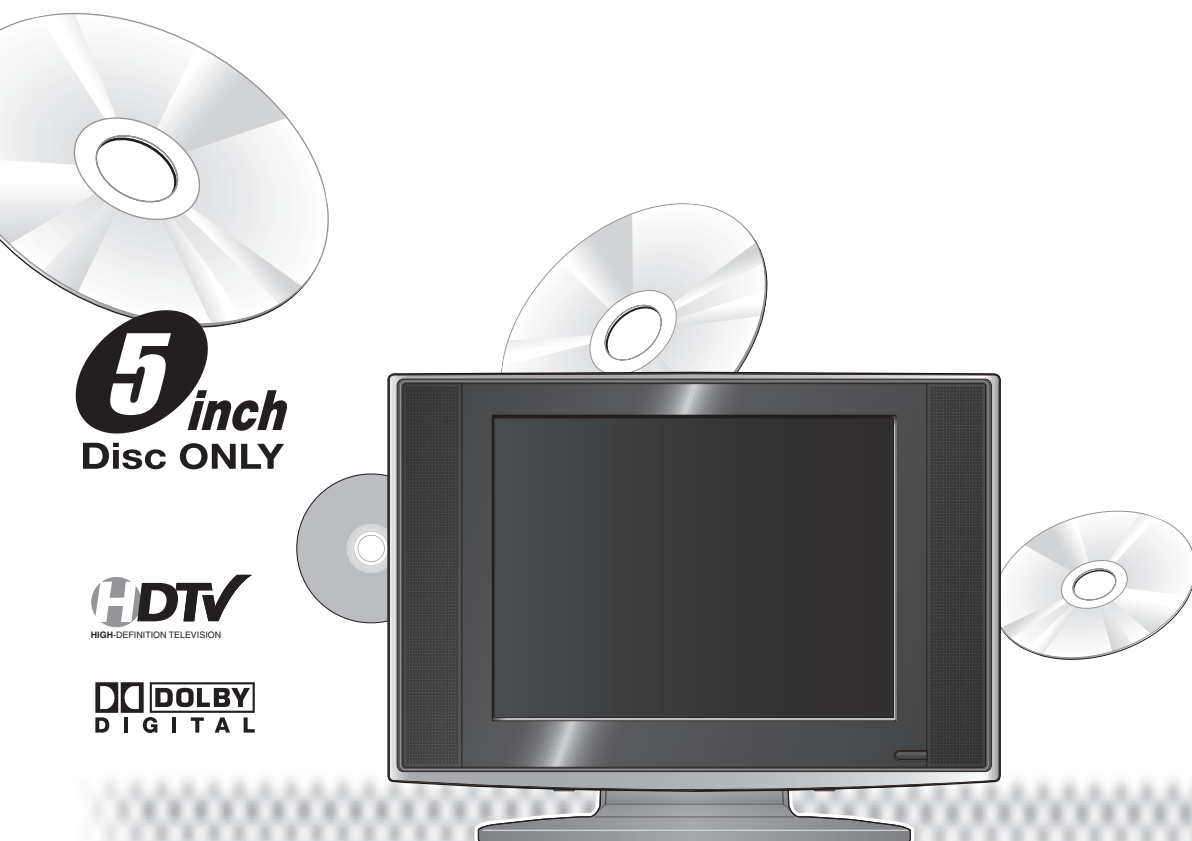

TO RECEIVE DIGITAL/ANALOG SIGNAL, YOU MUST CONNECT ANTENNA.

IF YOU NEED ADDITIONAL ASSISTANCE WITH SETUP OR OPERATING AFTER READING OWNER'S MANUAL, PLEASE CALL TOLL FREE **1-800-968-3429**, OR VISIT OUR WEB SITE AT **<http://www.SylvaniaConsumerElectronics.com>**

WARNING: TO REDUCE THE RISK OF FIRE OR ELECTRIC SHOCK, DO NOT EXPOSE THIS APPLIANCE TO RAIN OR MOISTURE.



CAUTION
RISK OF ELECTRIC SHOCK
DO NOT OPEN



CAUTION: TO REDUCE THE RISK OF ELECTRIC SHOCK, DO NOT REMOVE COVER (OR BACK). NO USER SERVICEABLE PARTS INSIDE. REFER SERVICING TO QUALIFIED SERVICE PERSONNEL.



THIS SYMBOL INDICATES THAT DANGEROUS VOLTAGE CONSTITUTING A RISK OF ELECTRIC SHOCK IS PRESENT WITHIN THIS UNIT.



THIS SYMBOL INDICATES THAT THERE ARE IMPORTANT OPERATING AND MAINTENANCE INSTRUCTIONS IN THE LITERATURE ACCOMPANYING THE APPLIANCE.

The important note is located on the rear of the cabinet.

Important Safeguards

- 1. READ INSTRUCTIONS** - All the safety and operating instructions should be read before the appliance is operated.
- 2. RETAIN INSTRUCTIONS** - The safety and operating instructions should be retained for future reference.
- 3. HEED WARNINGS** - All warnings on the appliance and in the operating instructions should be adhered to.
- 4. FOLLOW INSTRUCTIONS** - All operating and use instructions should be followed.
- 5. CLEANING** - Unplug TV from the wall outlet before cleaning. Do not use liquid cleaners or aerosol cleaners. Use a damp cloth for cleaning.
EXCEPTION: A product that is meant for uninterrupted service and, that for some specific reason, such as the possibility of the loss of an authorization code for a CATV converter, is not intended to be unplugged by the user for cleaning or any other purpose, may exclude the reference to unplugging the appliance in the cleaning description otherwise required in item 5.
- 6. ATTACHMENTS** - Do not use attachments not recommended by the TV manufacturer as they may cause hazards.
- 7. WATER AND MOISTURE** - Do not use this TV near water, for example, near a bath tub, wash bowl, kitchen sink, or laundry tub, in a wet basement, or near a swimming pool, and the like.
- 8. ACCESSORIES** - Do not place this TV on an unstable cart, stand, tripod, bracket, or table. The TV may fall, causing serious injury to someone, and serious damage to the appliance. Use only with a cart, stand, tripod, bracket, or table recommended by the manufacturer, or sold with the TV.
Any mounting of the appliance should follow the manufacturer's instructions and should use a mounting accessory recommended by the manufacturer. An appliance and cart combination should be moved with care. Quick stops, excessive force, and uneven surfaces may cause the appliance and cart combination to overturn.
AMEUBLES - Cet appareil ne doit être placé que sur un meuble (avec ou sans roulettes) recommandé par le fabricant. Si vous l'installez sur un meuble à roulettes, déplacez les deux ensembles avec précaution. Un arrêt brusque, l'utilisation d'une force excessive et des surfaces irrégulières risquent de déstabiliser l'ensemble et de le renverser.
- 9. VENTILATION** - Slots and openings in the cabinet and the back or bottom are provided for ventilation and to ensure reliable operation of the TV and to protect it from overheating, these openings must not be blocked or covered. The openings should never be blocked by placing the TV on a bed, sofa, rug, or other similar surface. This TV should never be placed near or over a radiator or heat register. This TV should not be placed in a built-in installation such as a bookcase or rack unless proper ventilation is provided or the manufacturer's instructions have been adhered to.
- 10. POWER SOURCES** - This TV should be operated only from the type of power source indicated on the marking label. If you are not sure of the type of power supply to your home, consult your appliance dealer or local power company. For TVs intended to operate from battery power, or other sources, refer to the operating instructions.



- 11. GROUNDING OR POLARIZATION** - This TV is equipped with a polarized alternating-current line plug (a plug having one blade wider than the other). This plug will fit into the power outlet only one way. This is a safety feature. If you are unable to insert the plug fully into the outlet, try reversing the plug. If the plug should still fail to fit, contact your electrician to replace your obsolete outlet. Do not defeat the safety purpose of the polarized plug.
- 12. POWER-CORD PROTECTION** - Power-supply cords should be routed so that they are not likely to be walked on or pinched by items placed upon or against them, paying particular attention to cords at plugs, convenience receptacles, and the point where they exit from the appliance.
- 13. OUTDOOR ANTENNA GROUNDING** - If an outside antenna or cable system is connected to the TV, be sure the antenna or cable system is grounded so as to provide some protection against voltage surges and built-up static charges. Article 810 of the National Electrical Code, ANSI/NFPA No. 70, provides information with respect to proper grounding of the mast and supporting structure, grounding of the lead-in wire to an antenna discharge unit, size of grounding conductors, location of antenna-discharge unit, connection to grounding electrodes, and requirements for the grounding electrode. (Fig. A)

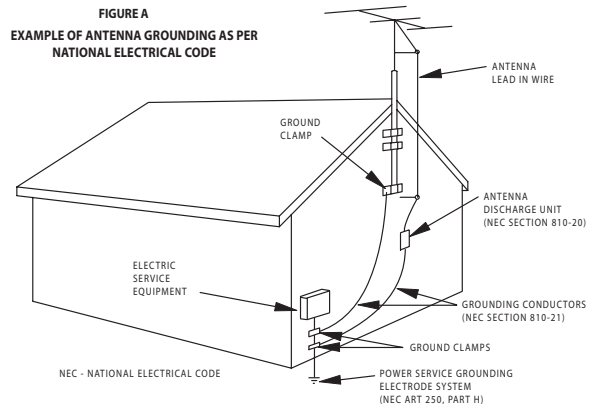

- 14. LIGHTNING** - For added protection for this TV receiver during a lightning storm, or when it is left unattended and unused for long periods of time, unplug it from the wall outlet and disconnect the antenna or cable system. This will prevent damage to the TV due to lightning and power-line surges.
- 15. POWER LINES** - An outside antenna system should not be located in the vicinity of overhead power lines or other electric light of power circuits, or where it can fall into such power lines or circuits. When installing an outside antenna system, extreme care should be taken to keep from touching such power lines or circuits as contact with them might be fatal.
- 16. OVERLOADING** - Do not overload wall outlets and extension cords as this can result in a risk of fire or electric shock.

- 17. OBJECT AND LIQUID ENTRY** - Never push objects of any kind into this TV through openings as they may touch dangerous voltage points or short out parts that could result in a fire or electric shock. Never spill liquid of any kind on the TV.
- 18. SERVICING** - Do not attempt to service this TV yourself as opening or removing covers may expose you to dangerous voltage or other hazards. Refer all servicing to qualified service personnel.
- 19. DAMAGE REQUIRING SERVICE** - Unplug this TV from the wall outlet and refer servicing to qualified service personnel under the following conditions:
- When the power supply cord or plug is damaged or frayed.
 - If liquid has been spilled, or objects have fallen into the TV.
 - If the TV has been exposed to rain or water.
 - If the TV does not operate normally by following the operating instructions. Adjust only those controls that are covered by the operating instructions, as improper adjustment of other controls may result in damage and will often require extensive work by a qualified technician to restore the TV to its normal operation.
- e. If the TV has been dropped or damaged in any way.
- f. When the TV exhibits a distinct change in performance, this indicates a need for service.
- 20. REPLACEMENT PARTS** - When replacement parts are required, be sure the service technician uses replacement parts specified by the manufacturer that have the same characteristics as the original part. Unauthorized substitutions may result in fire, electric shock, injury to persons or other hazards.
- 21. SAFETY CHECK** - Upon completion of any service or repairs to this TV, ask the service technician to perform routine safety checks to determine that the TV is in proper operating condition.
- 22. HEAT** - This TV product should be situated away from heat sources such as radiators, heat registers, stoves, or other products (including amplifiers) that produce heat.
- 23. WALL OR CEILING MOUNTING** - This TV product should be mounted to a wall or ceiling only as recommended by the manufacturer.

✓ Precautions

(Hg) LAMP IN LCD CONTAINS MERCURY, DISPOSE ACCORDING TO LOCAL, STATE OR FEDERAL LAW.

CAUTION: TO PREVENT ELECTRIC SHOCK, MATCH WIDE BLADE OF PLUG TO WIDE SLOT, FULLY INSERT.

ATTENTION: POUR ÉVITER LES CHOCS ÉLECTRIQUES, INTRODUIRE LA LAME LA PLUS LARGE DE LA FICHE DANS LA BORNE CORRESPONDANTE DE LA PRISE ET POUSSER JUSQU'AU FOND.

FCC WARNING This equipment may generate or use radio frequency energy. Changes or modifications to this equipment may cause harmful interference unless the modifications are expressly approved in the manual. The user could lose the authority to operate this equipment if an unauthorized change or modification is made.

RADIO-TV INTERFERENCE

This equipment has been tested and found to comply with the limits for a Class B digital device, pursuant to Part 15 of the FCC Rules. These limits are designed to provide reasonable protection against harmful interference in a residential installation. This equipment generates, uses, and can radiate radio frequency energy and, if not installed and used in accordance with the instructions, may cause harmful interference to radio communications. However, there is no guarantee that interference will not occur in a particular installation. If this equipment does cause harmful interference to radio or television reception, which can be determined by turning the equipment off and on, the user is encouraged to try to correct the interference by one or more of the following measures:

- 1) Reorient or relocate the receiving antenna.
- 2) Increase the separation between the equipment and receiver.
- 3) Connect the equipment into an outlet on a circuit different from that to which the receiver is connected.
- 4) Consult the dealer or an experienced radio/TV technician for help.

This Class B digital apparatus complies with Canadian ICES-003.

Cet appareil numérique de la classe B est conforme à la norme NMB-003 du Canada.

Note to CATV system installer:

This reminder is provided to call the CATV system installer's attention to Article 820-40 of the NEC that provides guidelines for proper grounding and, in particular, specifies that the cable ground should be connected to the grounding system of the building as close to the point of cable entry as practical.

LASER SAFETY

This unit employs a laser. Only a qualified service person should remove the cover or attempt to service this device, due to possible eye injury.

CAUTION: USE OF CONTROLS OR ADJUSTMENTS OR PERFORMANCE OF PROCEDURES OTHER THAN THOSE SPECIFIED HEREIN MAY RESULT IN HAZARDOUS RADIATION EXPOSURE.

CAUTION: VISIBLE AND INVISIBLE LASER RADIATION WHEN OPEN AND INTERLOCK DEFEATED. DO NOT STARE INTO BEAM.

LOCATION: INSIDE, NEAR THE DECK MECHANISM.

IMPORTANT COPYRIGHT INFORMATION

Unauthorized copying, broadcasting, public performance and lending of discs are prohibited. This product incorporates copyright protection technology that is protected by U.S. patents and other intellectual property rights. Use of this copyright protection technology must be authorized by Macrovision, and is intended for home and other limited viewing uses only unless otherwise authorized by Macrovision. Reverse engineering or disassembly is prohibited.



Manufactured under license from Dolby Laboratories. "Dolby" and the double-D symbol are trademarks of Dolby Laboratories.

LOCATION

For safe operation and satisfactory performance of the unit, keep the following in mind when selecting a place for its installation:

- Shield it from direct sunlight and keep it away from sources of intense heat.
- Avoid dusty or humid places.
- Avoid places with insufficient ventilation for proper heat dissipation. Do not block the ventilation holes at the top and bottom of the unit. Do not place the unit on a carpet because this will block the ventilation holes.
- Install the unit in a horizontal position.
- Avoid locations subject to strong vibration.
- Do not place the unit near strong magnetic fields.
- Avoid moving the unit to locations where temperature differences are extreme.
- Be sure to unplug the AC power cord from the outlet before carrying the unit.

TO AVOID THE HAZARDS OF ELECTRICAL SHOCK AND FIRE

- Do not handle the power cord with wet hands.
- Do not pull on the power cord when disconnecting it from an AC outlet. Grasp it by the plug.
- If, by accident, water is spilled on the unit, unplug the power cord immediately and take the unit to our authorized service center for servicing.
- Do not place anything directly on top of the unit.

MOISTURE WARNING

- Moisture condensation may occur inside the unit when it is moved from a cold place to a warm place, or after heating a cold room or under conditions of high humidity.

When the condensation occurs inside the unit, turn the unit on and leave it at least 2 hours to dry out.

The serial number of this product may be found on the back of the unit. No others have the same serial number as yours. You should record the number and other vital information here and retain this book as a permanent record of your purchase to aid identification in case of theft.

date of purchase	dealer phone No.	serial No.
dealer purchase from	model No.	dealer address

Note about recycling:

This product's packaging materials are recyclable and can be reused. Please dispose of any materials in accordance with your local recycling regulations.

Batteries should never be thrown away or incinerated but disposed of in accordance with your local regulations concerning chemical wastes.

✓ Supplied Accessories

owner's manual
(1EMN22143)

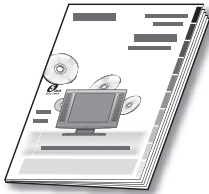

remote control
(NF603UD)



batteries
(AA x 2)

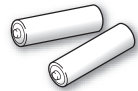

- If you need to replace these accessories, please refer to the part No. with the illustrations and call our toll free customer support line found on the cover of this manual.
- Depending on your antenna system, you may need different types of combiners (mixers) or separators (splitters). Contact your local electronics store for these items.

✓ Tilt Stand

You can adjust the stand to change the angle of the TV (-2.5° to 10°).

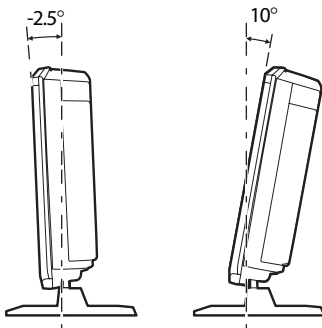

✓ Symbols Used in this Manual

The following is the description for the symbols used in this manual.

Description refers to:

TV FUNCTIONS	DVD FUNCTIONS
: Analog TV operation	: Playback of DVD-video
: Digital TV operation	: Playback of audio CD
• If neither symbol appears under the function heading, operation is applicable to both.	• If neither symbol appears under the function heading, operation is applicable to both.

✓ Contents

INTRODUCTION

Important Safeguards	2
Precautions	3
Supplied Accessories	4
Tilt Stand	4
Symbols Used in this Manual	4
Features	6
Remote Control Function	7
Installing the Batteries	7
Control Panel	8
Rear Panel	8
Attaching a Wall Mount Bracket (sold separately)	9

CONNECTION

Basic Connection	10
External Device Connection	11

TV Functions

INITIAL SETTING

Initial Setup	13
Main Menu	14
Auto Channel Scan	14
Language Selection	15

WATCHING TV

Channel Selection	16
Volume Adjustment	16
Switching Each Mode	17
Switching Audio Mode	17
Screen Information	18
TV Screen Display Mode	19
Sleep Timer	19

OPTIONAL SETTING

Channel Add/Delete	20
Picture Adjustment	20
Closed Caption	21
DTV Closed Caption	22
DTVCC Style	22
Back Light Setting	23
Color Temperature	24
V-chip	24

DVD Functions

OPERATING DVD

Playable Media	27
Unplayable Media	27
Playback	28
DVD Menu	28
Resume Playback	28
Pause	28
Step-by-step Playback	29
Fast Forward / Fast Reverse	29
Slow Forward / Slow Reverse	29
Zoom	29
Search Functions	30
Repeat Playback	31
Repeat A-B Playback	31
Programmed Playback	32
Random Playback	32
On-screen Display	33
Special Settings	34

DVD SETTING

DVD Language Setting	37
Display Setting	38
DVD Audio Setting	39
Parental Setting	40
Others	41
Reset to the Default Setting	42
Language Code List	42

TROUBLESHOOTING

Troubleshooting Guide	43
-----------------------------	----

INFORMATION

Glossary	45
Maintenance	45
Cable Channel Designations	46
General Specifications	46
Electrical Specification	46
Other Specifications	46

Limited Warranty	Back cover
------------------------	------------

© 2007 Funai Electric Co., Ltd.

All rights reserved. No part of this manual may be reproduced, copied, transmitted, disseminated, transcribed, downloaded or stored in any storage medium, in any form or for any purpose without the express prior written consent of Funai. Furthermore, any unauthorized commercial distribution of this manual or any revision hereto is strictly prohibited.

Information in this document is subject to change without notice. Funai reserves the right to change the content herein without the obligation to notify any person or organization of such changes.

FUNAI with the  design is a registered trademark of Funai Electric Co., Ltd and may not be used in any way without the express written consent of Funai. All other trademarks used herein remain the exclusive property of their respective owners. Nothing contained in this manual should be construed as granting, by implication or otherwise, any license or right to use any of the trademarks displayed herein. Misuse of any trademarks or any other content in this manual is strictly prohibited. Funai shall aggressively enforce its intellectual property rights to the fullest extent of the law.

✓ Features

TV

- **DTV/TV/CATV**
 - You can use your remote control to select channels which are broadcast in digital, conventional analog, standard definition. Also, cable subscribers can access their cable TV channels.
- **Program Information Display (DTV only)**
 - You can display the title, contents and other information of the current DTV program on the TV screen.
- **Auto Channel Scan**
 - This unit automatically scans and memorizes channels available in your area, eliminating difficult setup procedures.
- **V-chip**
 - This feature allows you to block children's access to inappropriate TV programs.
- **Closed Caption Decoder**
 - Built-in closed caption decoder displays text for closed caption supported programming.
- **MTS/SAP Tuner**
 - Audio language or stereo sound function can be selected from the remote control.
- **Auto Shut Off Function**
 - If there is no signal input from the antenna terminal and no operation for 15 minutes, the unit will turn itself off automatically.
- **Sleep Timer**
 - This feature will automatically turned off the power of the unit at a specific time.
- **Choices for On-screen Language**
 - Select your on-screen language: English, Spanish or French.
- **PLL Frequency Synthesized Tuning**
 - Provides free and easy channel selection and lets you tune directly to any channel using the channel number buttons on the remote control.
- **Component Video Input**
- **S-video Input**
- **AV Input**
- **Digital Audio Coaxial Output**

DVD

- **Dolby Digital Sound**
 - Enjoy Dolby Digital multi-channel surround sound when you connect the unit to your Dolby Digital decoder.
 - **Still / Fast / Slow / Step Playback**
 - Various playback modes are available including still pictures, fast forward/reverse, slow motion and step frames.
 - **DVD Menus in a Desired Language**
 - You can display DVD menus in a desired language, if available on a DVD-video.
 - **Screen Saver**
 - If there is no operation for 5 minutes, the screen saver program starts.
 - **Parental Lock**
 - Block the viewing of DVD-video unsuitable for children.
 - **Resume Play**
 - Lets you resume play back from the point at which playback was stopped.
 - **Bit Rate Indication**
 - **Dynamic range control (DRC)**
 - You can control the range of sound volume.
 - **Choices for Audio Language and Stereo Sound Function**
 - Select your desired language or stereo sound function when different options are available on your disc.
- ➔ **Accessing from [MODE] button**
- During playback**
- **Subtitles in a Desired Language**
 - You can select a desired language for displaying subtitle, if that language is available on a DVD-video.
 - **Selecting a Camera Angle**
 - You can select the desired camera angle, if a DVD contains sequences recorded from different angles.
 - **Zoom**
 - Allows you to enlarge the size of picture image.
 - **Black Level Adjustment**
 - **Virtual Surround**
 - **Search**
 - chapter search / title search / track search / time search
 - **Marker**
 - The part designated by user can be called back.
 - **Repeat**
 - chapter / title / track / all / A-B
- In stop mode**
- **Program Playback for audio CD**
 - You can program the order of tracks to play them back in designated order.
 - **Random Playback for audio CD**
 - This unit can shuffle the order of tracks to play them back in randomly.

✓ Remote Control Function

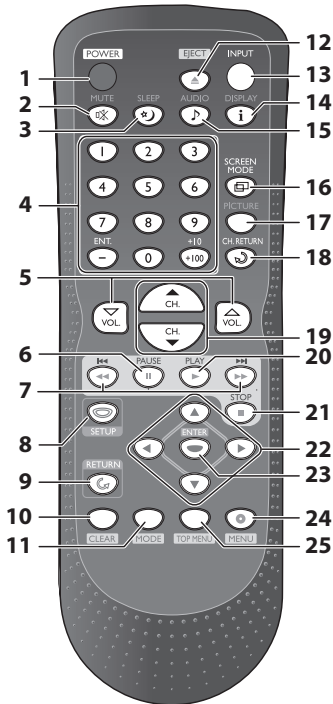

1. **POWER button** (p13)
Press to turn the unit on and off.
2. **MUTE button** (p16)
Press to turn the sound on and off.
3. **SLEEP button** (p19)
Press to activate the sleep timer.
4. **Number buttons** (p16)
 - Press to select channels.
 - Press to select chapter, title (DVD), or track (CD) directly.
- /ENT button
 - Press to shift the minor channel from the major channel.
- +10/+100 button
 - Press to select 100 or higher channels. (CATV)
 - Press to search if there are minor channels on the currently selected major channel. (DTV)

5. **VOL. Δ/∇ buttons** (p16)
Press to adjust the volume.
6. **PAUSE button** (p28)
Press to pause disc playback.
7. **SKIP \lll / \ggg button** (p30)
 - Press to skip forward or backward chapters, titles (DVD) or tracks (CD).
- REV \lll button** (p29)
 - Press and hold to begin slow reverse playback during the pause mode (DVD) and search backward through a disc.
- FWD \ggg button** (p29)
 - Press and hold to begin slow forward playback during the pause mode (DVD) and search forward through a disc.
8. **SETUP button** (p14 / p37)
Press to display the main menu.
9. **RETURN button** (p20)
Press to return to the previous menu operation.
10. **CLEAR button** (p31)
 - Press to clear the numbers entered incorrectly.
 - Press to cancel the point A for A-B repeat (DVD, CD).
 - Press to remove the track number in program input (CD).
11. **MODE button** (p6)
 - Press to arrange the playing order or playback randomly (CD).
 - Press to set the black level (DVD) and the virtual surround (DVD, CD) on or off.
 - Press to change the camera angle to see the sequence being played back from different angle (DVD-video).
 - Press to search chapter, title (DVD), time (DVD, CD) or track (CD).
 - Press to set the marker (DVD, CD).
 - Press to repeat playback chapter, title (DVD), track, disc (CD) repeatedly or between designated point A and B (DVD, CD).
 - Press to magnify the part of picture (approx. 1.3x, 2x and 4x : DVD).
 - Press to select the subtitles on a disc (DVD).

12. **EJECT \blacktriangle button** (p28)
Press to eject the disc.
13. **INPUT button** (p17)
Press to access a connected external device like a video game, camcorder or VCR.
14. **DISPLAY button** (p18 / p33)
Digital Mode (DTV)
 - Press to display the channel number and the program information.**Analog Mode (TV)**
 - Press to display the channel number.**External Input Mode**
 - Press to display the currently selected external input mode.
15. **AUDIO button** (p17 / p34)
Digital Mode (DTV)
 - Press to select the audio language.**Analog Mode (TV)**
 - Press to select the audio mode.**DVD Mode**
 - Press to select the audio language (DVD), or sound mode (CD).
16. **SCREEN MODE button** (p19)
Press to select aspect ratio available for the TV screen.
17. **PICTURE button** (p20)
Press to adjust the picture quality.
18. **CH. RETURN button** (p16)
Press to return to previous channel.
19. **CH. Δ/∇ buttons** (p16)
Press to select channels.
20. **PLAY \blacktriangleright button** (p28)
Press to begin disc playback.
21. **STOP \blacksquare button** (p28)
Press to stop disc playback.
22. **$\blacktriangleleft / \blacktriangleright / \blacktriangleup / \blacktriangledown$ buttons** (p13)
Press to move left/ right/ up/ down through the items.
23. **ENTER button** (p13)
Press to confirm your selection.
24. **MENU button** (p28)
Press to call up the menu on a disc.
25. **TOP MENU button**
Press to call up the top menu on a disc. (DVD-Video)

✓ Installing the Batteries

Install the batteries (AA x 2) matching the polarity indicated inside battery compartment of the remote control.

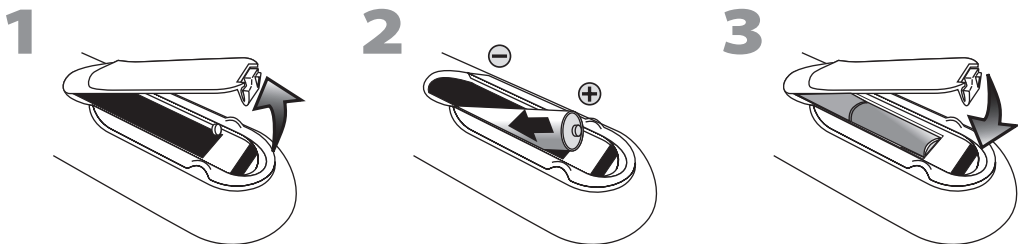

Battery Precautions:

- Be sure to follow the correct polarity as indicated in the battery compartment. Reversed batteries may cause damage to the device.
- Do not mix different types of batteries together (e.g., Alkaline and Carbon-Zinc) or old batteries with fresh ones.
- If the device is not to be used for a long period of time, remove the batteries to prevent damage or injury from possible battery leakage.
- Do not try to recharge batteries; they can overheat and rupture.

✓ Control Panel

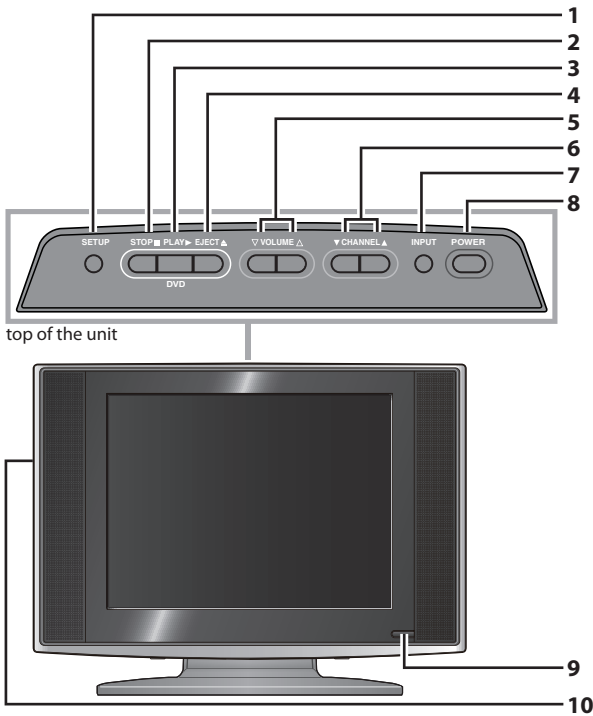

1. **SETUP button** (p14 / p37)
Press to display the main menu.
2. **STOP button** (p28)
Press to stop disc playback.
3. **PLAY button** (p28)
Press to begin disc playback.
4. **EJECT button** (p28)
Press to eject the disc.
5. **VOLUME Δ/∇ buttons** (p16)
Press to adjust the volume.
6. **CHANNEL $\blacktriangle/\blacktriangledown$ buttons** (p16)
Press to select channels or move up/down through the main menu items.
7. **INPUT button** (p17)
Press to select the digital, analog or external input.
8. **POWER button** (p13)
Press to turn the unit on and off.
9. **Infrared Sensor Window**
Receives infrared rays transmitted from the remote control.
10. **Disc Loading Slot** (p28)
Insert the disc with label facing back of this unit.

✓ Rear Panel

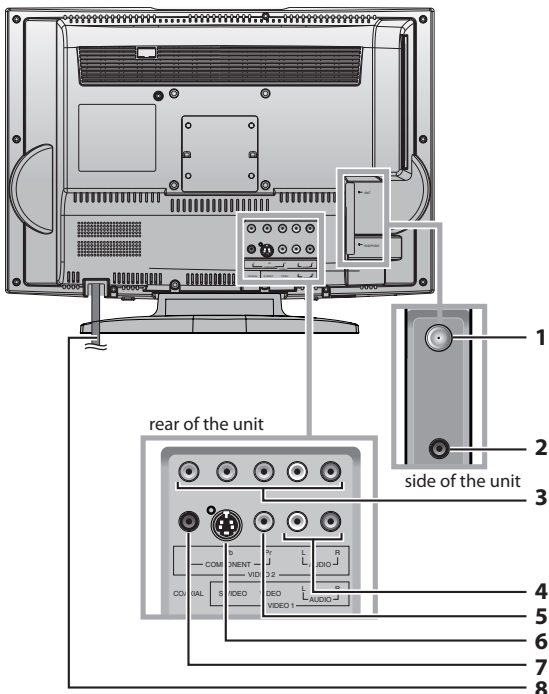

1. **ANT jack** (p10)
RF coaxial cable connection for your antenna or cable box.
2. **HEADPHONE jack**
Headphone connection for personal listening.
3. **COMPONENT and AUDIO input jacks** (p11)
Component video cable connection for an external device.
Use component video and audio output jacks of an external device.
4. **AUDIO input jacks** (p11)
RCA audio cable connection for an external device.
5. **VIDEO input jack** (p12)
RCA video cable connection for an external device.
6. **S-VIDEO input jack** (p11)
S-video cable connection for an external device.
7. **COAXIAL (digital audio) output jack** (p12)
Digital audio coaxial cable connection for a decoder or an audio receiver.
Use digital audio input jack of an external device.
8. **AC power cord**
Connect to a standard AC outlet to supply power to this unit.

✓ Attaching a Wall Mount Bracket (sold separately)

The following is a description of the method for attaching a wall mount to this unit.

When performing this operation, refer to the instruction manual included with the wall mount kit.

⚠ CAUTION

- Any damage caused by incorrectly attempting to mount this unit is not covered under the terms of the manufacturers warranty.
- This unit may be used only with VMFb manufactured by CSAV.
- Use with other wall mounts may result in instability causing possible injury.

You need the following wall mount kit for this unit.

Vision Mount LCD Mounts

Model number: VMFb

For more information, please visit CSAV website at www.csavinc.com

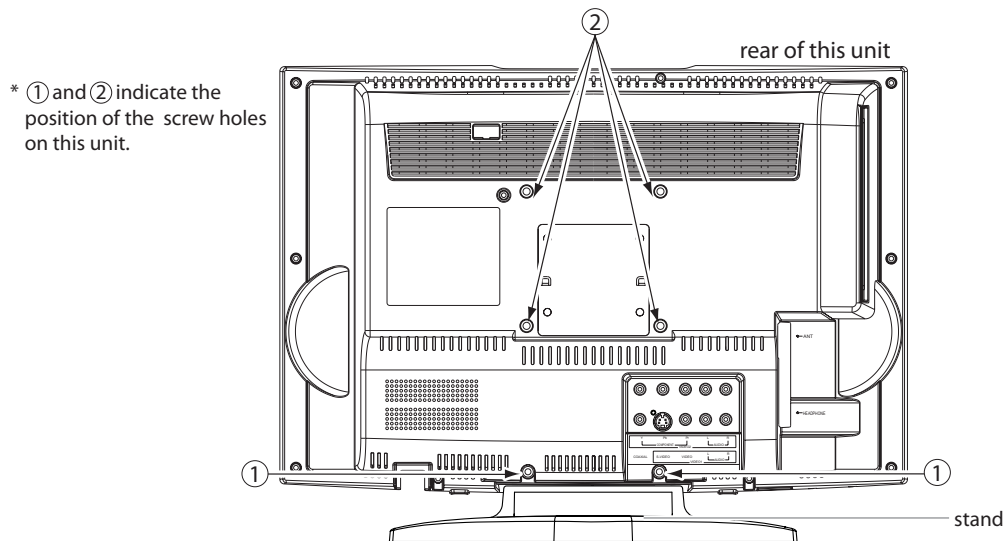

- 1 Turn this unit over and place it screen-first onto a table which has a soft cloth draped over it. Place this unit in a way so that the stand hangs over the edge of the table.

Note:

- Make sure to use a table which can support the weight of this unit and is larger than this unit.
- Make sure the table is in a stable location.

- 4 Attach this unit to the wall.

Note:

- Refer to the instruction manual included with the wall mount kit when securing this unit to the wall.

- * If you want to attach the stand of this unit again, insert the stand slowly as illustrated below and drive M4 screws in the 4 threaded holes (①).

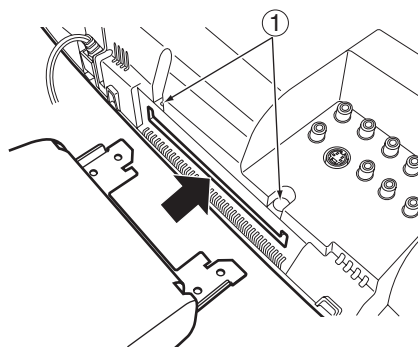

- 2 Remove the stand from this unit. Unscrew the M4 screws indicated by ① and remove the stand. Please be careful with the unit after you remove the stand.

Note:

- The M4 screws and stand you have removed are necessary for reattachment at a later date. Make sure to keep them in a safe place.

- 3 Attach the monitor plate to this unit using the 4 bolts included with the wall mount kit. You do not need to use the lock washers for mounting this unit.

Note:

- Only use the screw holes indicated by ② for mounting this unit.
- For instructions on how to attach the monitor plate, refer to the instruction manual included with the wall mount kit.

Cables not included.

Please purchase the necessary cables at your local store.

✓ Basic Connection

This section describes how to connect the unit to an antenna, cable/satellite box, etc.

Note:

- Be sure your antenna or other device is connected properly before plugging in the power cord.

[Antenna Cable Connection]

When connecting the unit to an antenna or cable TV company (without cable/satellite box)

Connect the RF coaxial cable on your home outlet to the antenna input jack of this unit.

e.g.)

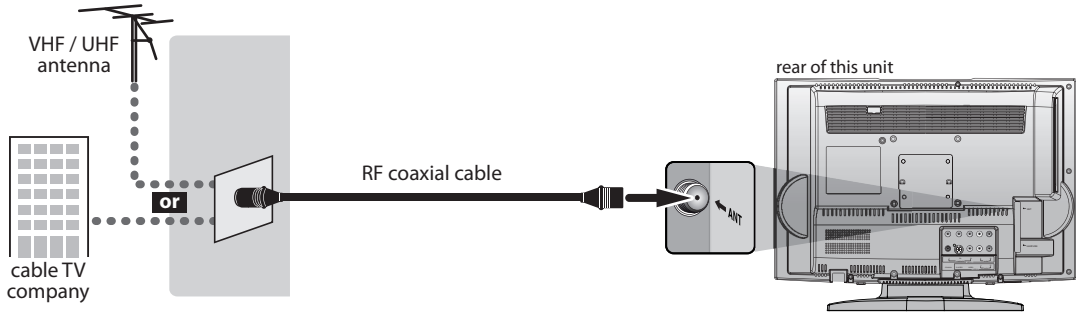

*Once connections are completed, turn on the unit and begin initial setup.

Channel scanning is necessary for the unit to memorize all available channels in your area.

(Refer to "Initial Setup" on page 13.)

Note:

- For your safety and to avoid damage to device, please unplug the RF coaxial cable from the antenna input jack before moving the unit.
- If you use an antenna to receive analog TV, it should also work for DTV reception. Outdoor or attic antennas will be more effective than set-top versions.
- To easily switch your reception source between antenna and cable, install an antenna selector.
- If you connect to the cable system directly, contact the CATV installer.

[Connection to Cable Box or Satellite Box]

Connect the RF coaxial cable on your home outlet to the input jack of the cable/satellite box.

Use another RF coaxial cable to connect the antenna input jack of the unit to the output jack of the cable/satellite box.

e.g.)

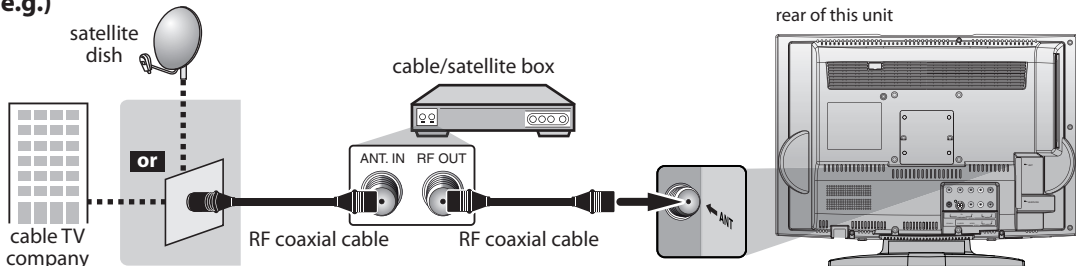

*Required cables and connecting methods differ depending on the cable/satellite box.

For more information, please contact your cable/satellite provider.

Cables not included.

Please purchase the necessary cables at your local store.

External Device Connection**[Component Video Cable Connection]**

Component video connection offers better picture quality for video devices connected to the unit.

Use a component video cable to connect the unit to external video devices equipped with component video output jacks.

If you connect to the unit's component video input jack, connect RCA audio cables to the audio L/R jacks of VIDEO2.

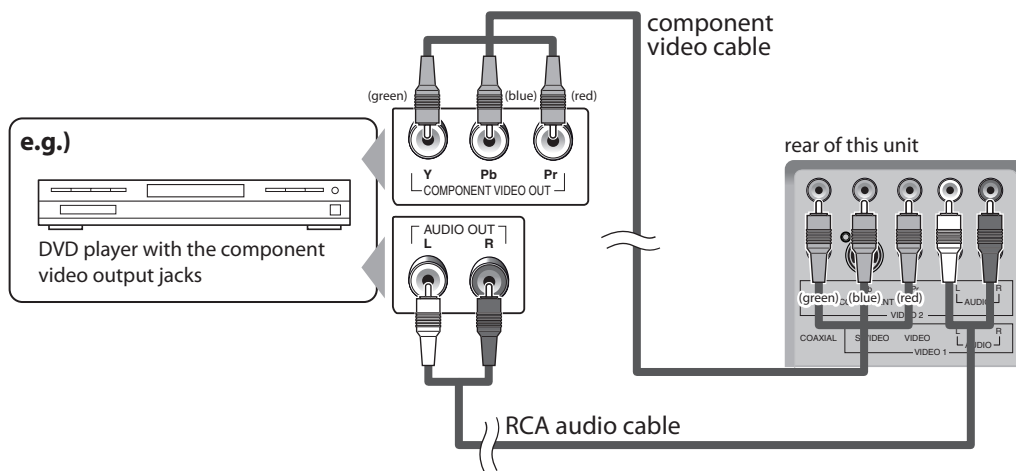
**Note:**

- This unit accepts 480i / 480p / simplified 1080i video signals.
- Simplified 1080i video signal differs to the original 1080i video signal because it is displayed after converted into 480p signal.

[S-video Cable Connection]

S-video connection offers good picture quality for video devices connected to the unit.

Use an S-video cable to connect the unit to external video devices equipped with S-video output jack.

If you connect to the unit's S-video input jack, connect RCA audio cables to the audio L/R jacks of VIDEO1.

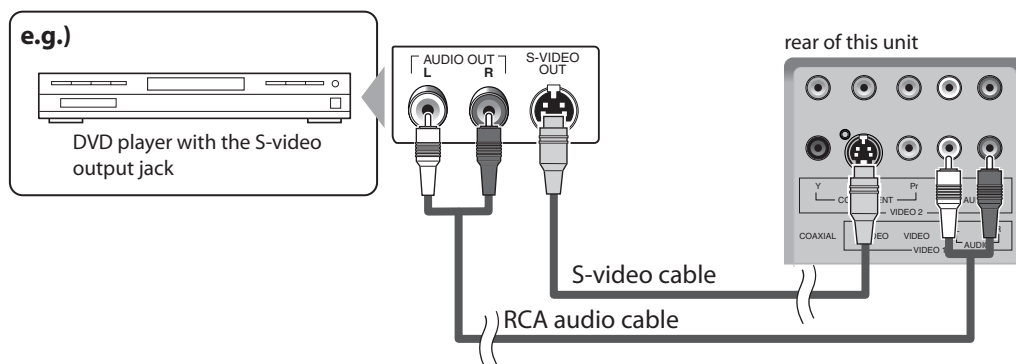
**Note:**

- If you connect to the S-video jack and the video jack at the same time, the S-video connection will have priority.

Cables not included.

Please purchase the necessary cables at your local store.

[Video Connection]

Video connection offers standard picture quality for video devices connected to the unit.

If you connect to the unit's video input jack, connect RCA audio cables to the audio L/R jacks of VIDEO1.

When the audio jack of the video device is monaural, connect the RCA audio cable to the audio L input jack.

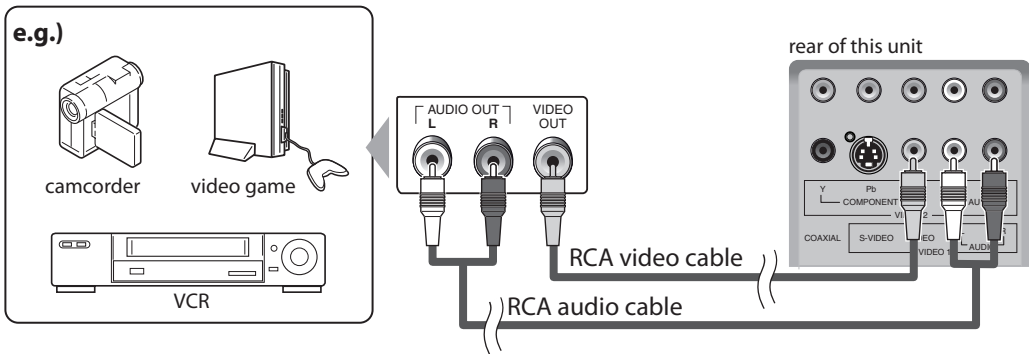

Note:

- If you connect to the S-video jack and the video jack at the same time, the S-video connection will have priority.

[Digital Audio Output Connection]

If you connect this unit to an external digital audio device, you can enjoy multi-channel audio like 5.1ch digital broadcasting sound.

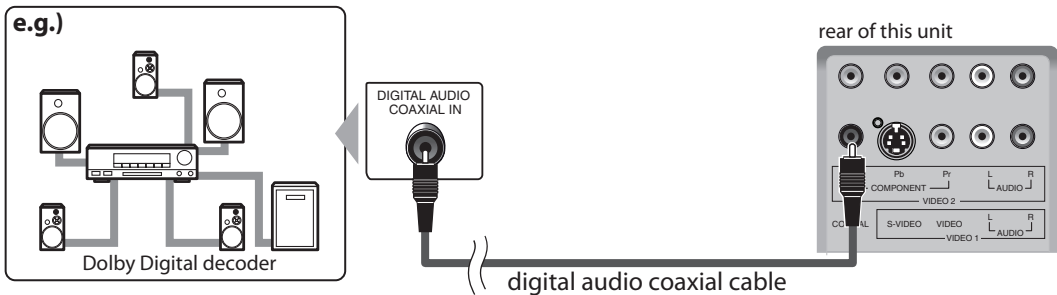

✓ Main Menu

This section describes the overview of the main menu displayed when you press [SETUP]. For more details, see the reference page for each item. The main menu consists of the function setting items below.

Press [SETUP].



e.g.) digital TV mode

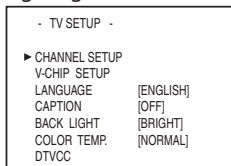

• CHANNEL SETUP

You can automatically scan the viewable channels and remove those that are undesired. (Refer to “Auto Channel Scan” on page 14.)

• V-CHIP SETUP

You can set the viewing limitations. (Refer to “V-chip” on page 24.)

• LANGUAGE

You can change the language (English, Spanish, French) displayed on the main menu. (Refer to “Language Selection” on page 15.)

• CAPTION

You can change the display format for closed caption, which displays the dialogue of a TV program or other information across the TV screen. (Refer to “Closed Caption” on page 21.)

• BACK LIGHT

You can set the desired brightness mode. (Refer to “Back Light Setting” on page 23.)

• COLOR TEMP

You can adjust color temperature (“NORMAL”, “WARM” and “COOL”). (Refer to “Color Temperature” on page 24.)

• DTVCC

In addition to the basic closed caption described on page 22, DTV has its own closed caption called DTVCC. (Refer to “DTV Closed Caption” on page 22.)

✓ Auto Channel Scan

If you switch wires (e.g., between antenna and CATV) or if you move the unit to a different area after the initial setting, or if you restore the DTV channel you deleted, you will need to perform auto channel scan.

Before you begin:

Make sure if the unit is connected to antenna or cable.

1 Press [SETUP] to display the main menu.



2 Use [Cursor ▲/▼] to select “CHANNEL SETUP”, then press [ENTER].



e.g.) digital TV mode

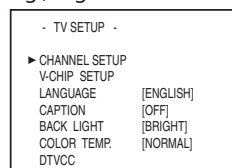

3 Use [Cursor ▲/▼] to select your desired preset type, then press [ENTER].



e.g.) digital TV mode

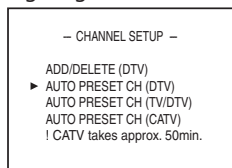

- When aerial antenna is connected, select “AUTO PRESET CH(TV)”, “AUTO PRESET CH(DTV)” or “AUTO PRESET CH(TV/DTV)”.
- When connected to CATV, select “AUTO PRESET CH (CATV)”.
- Scanning and memorizing the channels automatically start.

e.g.) digital TV mode

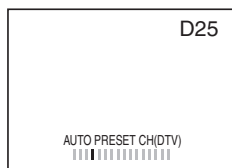

- When the scanning and memorizing are completed, the lowest memorized channel will be displayed.
- When you selected “AUTO PRESET CH(TV/DTV)”, the lowest memorized analog channel will be displayed when the scanning and memorizing are completed. If there is no analog channel, the lowest memorized digital channel will be displayed.

Note:

- If you connect the cable system directly, contact the CATV installer.
- If you press **[POWER]** or **[SETUP]** during auto channel scan, the setting will be canceled.
- When no channel can be received by auto channel scan, "NO TV SIGNALS" will be displayed on the TV screen.
- Channel settings will be saved even if the power fails.
- If you have Spanish or French menus and need English, press **[SETUP]**. Use **[Cursor ▲/▼]** to select "IDIOMA" or "LANGAGE". Press **[ENTER]** to select "ENGLISH". Press **[SETUP]** to remove the main menu.
- With regard only to the digital channel, even after the scanning is complete if you unplug the AC power cord before turning off the unit by pressing **[POWER]**, the channel setting may be lost.

✓ Language Selection

You can choose English, Spanish, or French as your on-screen language.

- 1 Press **[SETUP]** to display the main menu.



- 2 Use **[Cursor ▲/▼]** to select "LANGUAGE"; then press **[ENTER]** repeatedly to change the setting.



e.g.) digital TV mode

```

- TV SETUP -
CHANNEL SETUP
V-CHIP SETUP
▶ LANGUAGE [ENGLISH]
CAPTION [OFF]
BACK LIGHT [BRIGHT]
COLOR TEMP. [NORMAL]
DTVCC
  
```

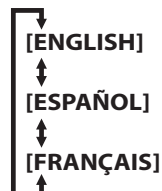

- 3 Press **[SETUP]** to exit.



✓ Channel Selection

Select channels by pressing [CH. ▲/▼] or [the Number buttons].

- To select the memorized channels, use [CH. ▲/▼] or [the Number buttons].
- To select the non-memorized channels use [the Number buttons].

To Use [the Number buttons]

TV

- When selecting analog channel 12



DTV

- When selecting digital channel 12-1

Be sure to press [-/ENT.] before entering the minor channel number.



- Press [CH. RETURN] to return to the previously viewed channel.
- When you select a channel larger than 100, press [+100] first. Then use [the Number buttons] to press the lower 2-digit numbers.

About digital TV broadcasting:

With its high definition broadcast, digital broadcasting far surpasses analog broadcasting in both its picture and sound quality.

What is the minor channel?

By using high compression technology, digital broadcasting offers a service that enables multiple signals to send simultaneously. Therefore, you can select more than one program per major channel since digital broadcasting technology distinguishes between multiple channels broadcast by a single network.

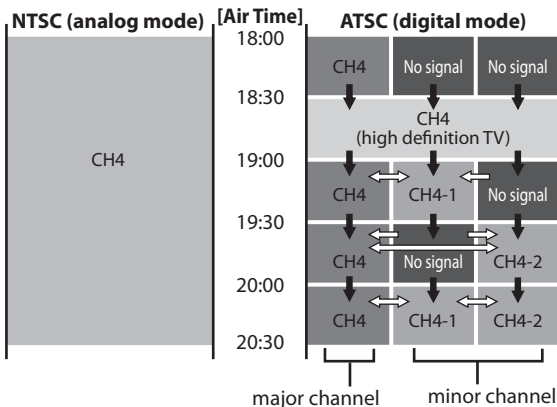

➔ : change automatically

⇔ : change manually by using [CH. ▲/▼]

Note:

- "NO SIGNAL" will appear on the TV screen after the minor channel broadcast is over.

✓ Volume Adjustment

This section describes how to adjust the volume. The mute function, which turns the sound off and on, is also described.

Use [VOL. ▲/▼] to adjust the audio volume.

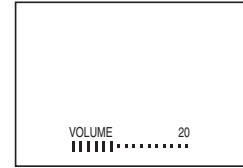

- The volume bar will be displayed at the bottom of the TV screen when adjusting the volume.
- The volume bar display will automatically disappear in a few seconds.

Press [MUTE] to turn off and on the sound.

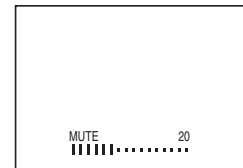

- "MUTE" is displayed on the TV screen for a few seconds.

Press [MUTE] again or [VOL. ▲/▼] to recover the original volume.

✓ Switching Each Mode

You can easily switch with the remote control to the DTV (ATSC) and TV (NTSC) or to access an external device when they are connected to the unit.

- 1 Press **[INPUT]** repeatedly to cycle through analog TV, digital TV, VIDEO1 and VIDEO2.

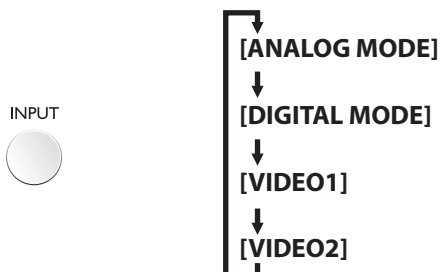

- To use the video or S-video input jack on the unit, select "VIDEO1".
- To use the component video input jack on the unit, select "VIDEO2".

Note:

• When you switch the analog mode to the digital mode, it may take a while until the digital channel selection is completed. The following TV screen is displayed while switching the mode.

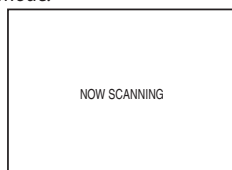

✓ Switching Audio Mode

This section describes how to switch the audio in the analog mode and how to switch the audio language in the digital mode.

TV

While receiving an MTS broadcast, press **[AUDIO]** repeatedly to cycle through the available audio channel.



- MAIN** : Outputs main-audio
- SAP** : Outputs second audio program
- MONO** : Outputs mono-audio
- The current mode will automatically disappear in 10 seconds.

DTV

- 1 Press **[AUDIO]** to display the currently selected language and the number of available languages.

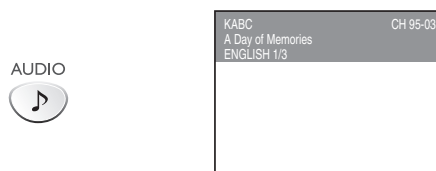

- 2 Press **[AUDIO]** repeatedly to cycle through the available audio languages.

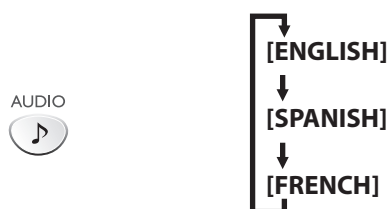

- Available languages differ depending on the broadcast. "OTHER" is displayed when the audio language cannot be acquired, or the acquired languages are other than English, Spanish or French.
- The current mode will automatically disappear in 10 seconds.

Note:

- Pressing **[AUDIO]** does not control external audio device.

✓ Screen Information

You can display the currently selected channel or other information such as the audio mode on the TV screen.

TV

In the analog mode, the current channel number is displayed.

Press **[DISPLAY]**.

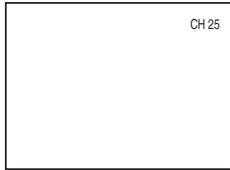

- The current channel number is displayed at the top-right corner of the TV screen.
- To clear the display, press **[DISPLAY]** again.

DTV

In the digital mode, the detailed broadcasting information for the current channel such as program title, program guides are displayed.

Press **[DISPLAY]** repeatedly to cycle through the available display modes.

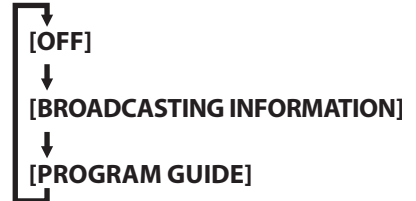

[Broadcasting Information]

- The following information is displayed.
 - 1 channel number
 - 2 broadcast station
 - 3 program title
 - 4 audio language
 (Refer to "Switching Audio Mode" on page 17.)

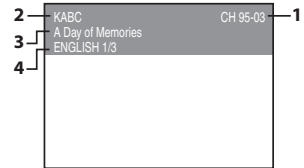

[Program Guide]

- The program guide added to broadcasting information is displayed.

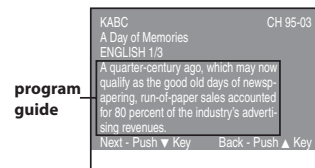

Note:

- When the program guide consists of more than 6 lines, use **[Cursor ▲/▼]** to scroll.
- "No description provided" is displayed when the program guide is not provided.
- While the program guide is displayed, the closed caption function is interrupted.
- In external input mode, the following screen is displayed; e.g.) When an external device is connected to VIDEO1 input jack.



- Available languages differ depending on the broadcast.
- The information display will automatically disappear in 1 minute.
- Pressing **[AUDIO]** does not control external audio device.

✓ TV Screen Display Mode

DTV

2 types of display modes can be selected in the digital mode when the broadcasting station is sending 16:9 video signal.

Press **[SCREEN MODE]** repeatedly to switch the TV aspect ratio.

SCREEN
MODE

LETTERBOX

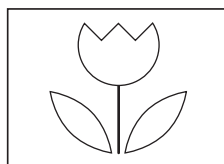

ZOOM

[LETTERBOX]

Display the digital-supported program in full-screen. Black borders will spread in the upper and lower screen.

[ZOOM]

Enlarge and display the center area of the digital-supported program.

The right and left side of image will be cut off.

Note:

- You may not switch the display mode depending on the program.

✓ Sleep Timer

The sleep timer can be set to automatically turn off the unit after an incremental period of time.

1 Press **[SLEEP]** to set the sleep timer.

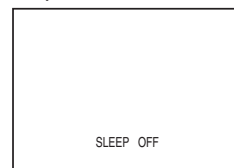

- Sleep timer display appears on the TV screen.

2 Press **[SLEEP]** repeatedly to change the amount of time until shut off.

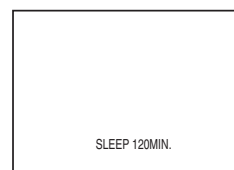

- You can set your unit to turn off after a set period of time (from 30 to 120 minutes).
- Each press of **[SLEEP]** will increase the time by 30 minutes.
- After set up, the sleep timer display can be called up for checking by pressing **[SLEEP]**.

To Cancel the Sleep Timer

Press **[SLEEP]** repeatedly until "SLEEP OFF" is displayed on the TV screen.

Note:

- The sleep timer setting display will automatically disappear in 10 seconds.
- When you disconnect the unit from the AC outlet or when a power failure occurs, the sleep timer setting will be canceled.

✓ Channel Add/Delete

The channel add/delete function lets you add the channel that was not added by the auto channel scan due to the reception status at the initial setting. You can also delete the unnecessary channels.

1 Press **[SETUP]** to display the main menu.



2 Use **[Cursor ▲/▼]** to select "CHANNEL SETUP", then press **[ENTER]**.



e.g.) digital TV mode

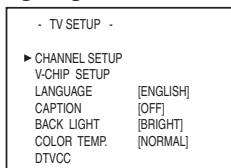

3 Use **[Cursor ▲/▼]** to select "ADD/DELETE(DTV)" or "ADD/DELETE", then press **[ENTER]**.



e.g.) digital TV mode

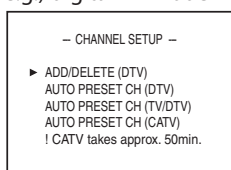

4 Select the channel you want to add or delete. (Refer to "Channel Selection" on page 16.)

e.g.) digital TV mode

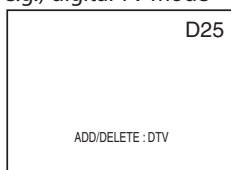

5 Use **[Cursor ◀/▶]** to select "ADD" or "DELETE".

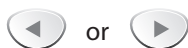

- To add or delete another channels, repeat steps 4-5.
- Color of channel number displayed at the right top of the TV screen indicates;
 - Blue: The selected channel will be added.
 - Red: The selected channel will be deleted.

6 Press **[SETUP]** to exit.



Note:

- "ADD/DELETE(DTV)" or "ADD/DELETE" menu will disappear automatically in about 10 seconds.
- In the digital mode (DTV), you can add or delete channels only for major channel.
- Once you delete a DTV channel, you cannot recover the channel without performing auto channel scan again. (Refer to "Auto Channel Scan" on page 14.)

✓ Picture Adjustment

You can adjust brightness, contrast, color, tint and sharpness.

1 Press **[PICTURE]** to adjust the picture quality.



2 Use **[Cursor ▲/▼]** to select the picture quality type you want to adjust.

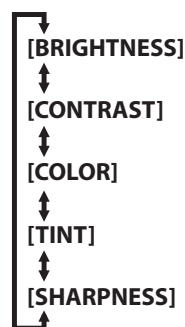

3 Within 5 seconds, use **[Cursor ◀/▶]** to adjust the quality.

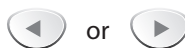

	Cursor ◀	Cursor ▶
BRIGHTNESS	to decrease brightness	to increase brightness
CONTRAST	to decrease contract	to increase contract
COLOR	to decrease color	to brighten color
TINT	to add purple	to add green
SHARPNESS	to make soft	to make clear

4 Press **[RETURN]** to exit.



Note:

- The picture adjustment setting display will automatically disappear in 10 seconds.

✓ Closed Caption

TV

You can view closed captioning (cc) for TV programs, movies and news. Closed caption refer to text of dialogue or descriptions displayed on-screen for the hearing impaired.

1 Press **[SETUP]** to display the main menu.



2 Use **[Cursor ▲/▼]** to select "CAPTION", then press **[ENTER]** repeatedly to change the setting.

e.g.) digital TV mode

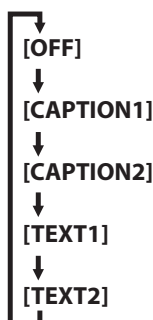
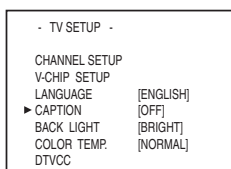

[Caption Mode]

CAPTION1 and TEXT1;

are the primary caption and text services. The captioning or text is displayed in the same language as the program's dialogue (up to 4 lines of script on the TV screen, where it does not obstruct relevant parts of the picture).

CAPTION2 and TEXT2;

are rarely available and broadcasters use them only in special conditions, such as when "CAPTION1" or "TEXT1" is not available.

• There are 3 display modes according to programs:

Paint-on mode: Displays input characters on the TV screen immediately.

Pop-on mode: Once characters are stored in memory, they are displayed all at once.

Roll-up mode: Displays the characters continuously by scrolling (max. 4 lines).

3 Press **[SETUP]** to exit.



Note:

- To show the closed caption on your TV screen, broadcast signal must contain the closed caption data.
- Not all TV programs and commercials have the closed caption or all types of the closed caption.
- Captions and texts may not match the TV voice exactly.
- Changing channels may delay the closed caption for a few seconds.
- Adjusting or muting the volume may delay the closed caption for a few seconds.
- Abbreviations, symbols and other grammatical shortcuts may be used in order to keep pace with the on-screen action. This is not a problem with the unit.
- The caption or text characters will not be displayed while the main menu or functions display is shown.
- If a black box appears on the TV screen, this means that the closed caption is set to TEXT mode. To clear the box, select "CAPTION 1", "CAPTION 2" or "OFF".
- If the unit receives poor quality television signals, the captions may contain errors, or there might be no captions at all. Some possible causes of poor quality signals are:
 - Automobile ignition noise
 - Electric motor noise
 - Weak signal reception
 - Multiplex signal reception (ghosts or screen flutter)
- The unit retains the closed caption setting if the power fails.

DTV Closed Caption

DTV

In addition to the basic closed caption described on page 21, DTV has its own closed caption called DTVCC. Use this menu to change the settings for DTVCC.

1 Press **[SETUP]** to display the main menu.



2 Use **[Cursor ▲/▼]** to select "DTVCC", then press **[ENTER]**.



e.g.) digital TV mode

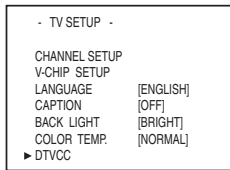

3 Use **[Cursor ▲/▼]** to select "CAPTION SERVICE", then press **[ENTER]** repeatedly to change the setting.

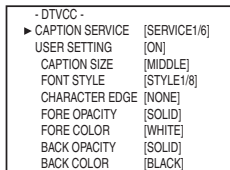

CAPTION SERVICE	OFF	Select if you do not want DTVCC. This is the default.
	SERVICE1~6	Select one of these before changing any other item in "CAPTION" menu. Choose "SERVICE1/6" under normal circumstances.

4 Press **[SETUP]** to exit.



Note:

- "CAPTION SERVICE" that you can switch differs depending on the broadcast description.

DTVCC Style

DTV

You can change the style of DTV CC such as font, color or size, etc.

1 Press **[SETUP]** to display the main menu.



2 Use **[Cursor ▲/▼]** to select "DTVCC", then press **[ENTER]**.



e.g.) digital TV mode

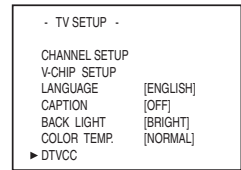

3 Use **[Cursor ▲/▼]** to select "USER SETTING", then press **[ENTER]** repeatedly to set to "ON".

- Items in the dotted box are available only when "USER SETTING" is "ON".

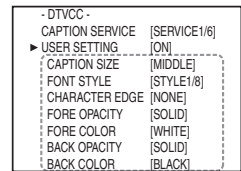

4 Use **[Cursor ▲/▼]** to select an item, then press **[ENTER]** repeatedly to change the setting for the item.

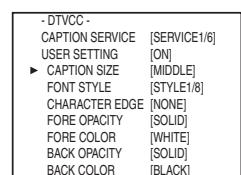

✓ Back Light Setting

You can set the desired brightness mode.

• CAPTION SIZE

Closed captioning font size can be changed as below.

• FONT STYLE

Font style of the displayed caption can be switched as below.

• CHARACTER EDGE

Edge type of the displayed caption can be switched as below.

• FORE COLOR, BACK COLOR

Font and background color of the displayed caption can be switched as below.

• FORE OPACITY, BACK OPACITY

Text and background opacity of the displayed caption can be switched as below.

CAPTION SIZE	MIDDLE, LARGE, SMALL	
FONT STYLE	STYLE1/8	Proportional font used in the menu screen.
	STYLE2/8	Monospaced with serifs.
	STYLE3/8	Proportionally spaced with serifs.
	STYLE4/8	Monospaced with serifs.
	STYLE5/8	Proportionally spaced without serifs.
	STYLE6/8	Casual font type.
	STYLE7/8	Cursive font type.
	STYLE8/8	Small capitals.
CHARACTER EDGE	NONE, RAISED, DEPRESSED, UNIFORM, SHADOW LEFT, SHADOW RIGHT	
FORE OPACITY	SOLID, TRANSLUCENT, FLASH	
FORE COLOR	WHITE, BLACK, RED, GREEN, YELLOW, BLUE, MAGENTA, CYAN, TRANSPARENT	
BACK OPACITY	SOLID, TRANSLUCENT, FLASH	
BACK COLOR	BLACK, RED, GREEN, BLUE, YELLOW, MAGENTA, CYAN, TRANSPARENT, WHITE	

1 Press **[SETUP]** to display the main menu.



2 Use **[Cursor ▲/▼]** to select "BACK LIGHT", then press **[ENTER]** repeatedly to change the setting.



e.g.) digital TV mode

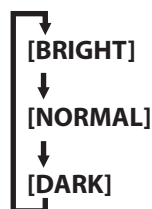
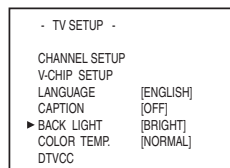

3 Press **[SETUP]** to exit.



5 Press **[SETUP]** to exit.



✓ Color Temperature

You can adjust color temperature of the TV screen.

1 Press **[SETUP]** to display the main menu.



2 Use **[Cursor ▲/▼]** to select "COLOR TEMP.", then press **[ENTER]** repeatedly to change the setting.

e.g.) digital TV mode

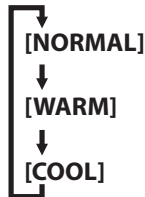
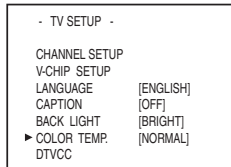

3 Press **[SETUP]** to exit.



✓ V-chip

V-chip reads the ratings for programs, then denies access to the programs which exceed the rating level you set. With this function, you can block certain programming inappropriate for children.

1 Press **[SETUP]** to display the main menu.



2 Use **[Cursor ▲/▼]** to select "V-CHIP SETUP", then press **[ENTER]**.

e.g.) digital TV mode

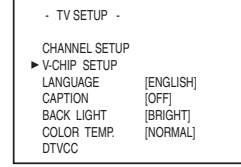

3 Use **[the Number buttons]** to enter the 4-digit numbers for your password.

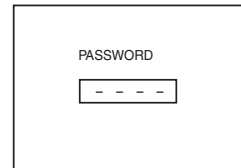

- When you have not set up your password, enter 0000.
- When the password is correct, the following "V-CHIP SETUP" menu is displayed.

See the following description for setting each item.

e.g.) digital TV mode

A... "A. TV Rating" ⇒ page 25

B... "B. MPAA Rating" ⇒ page 26

C... "C. Change Password" ⇒ page 26

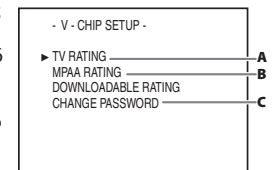

Note:

- "DOWNLOADABLE RATING" will be available when the unit receives a digital broadcast using the new rating system.
- When you select a rating and set it to "BLOCK", the higher ratings will be blocked automatically. The lower ratings will be available for viewing.
- When you set the highest rating to "VIEW", all ratings turn to "VIEW" automatically.
- If the "PROTECTED PROGRAM" message appears during your TV viewing, change to a channel that is not blocked. Then, you can access "V-CHIP SETUP" menu and change the setting to allow all TV viewing.
- To block any inappropriate programming, set your limits in both "TV RATING" and "MPAA RATING".
- The V-chip setting will be retained after a power failure (except the access code reverts to 0000).

A. TV Rating

- 4** Use [Cursor ▲/▼] to select "TV RATING", then press [ENTER].



e.g.) digital TV mode

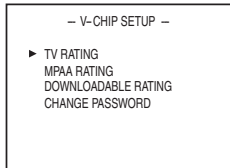

- 5** Use [Cursor ▲/▼] to select the desired rating, then press [ENTER] repeatedly to switch between "VIEW" and "BLOCK".

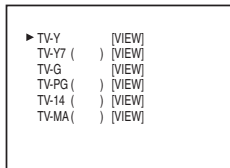

Rating	Category	
TV-Y	Appropriate for all children	lower ↑ ↓ higher
TV-Y7	Appropriate for all children 7 and older	
TV-G	General audience	
TV-PG	Parental guidance suggested	
TV-14	Unsuitable for children under 14	
TV-MA	Mature audience only	

[To Set the Sub Ratings]

As for TV-Y7, TV-PG, TV-14 or TV-MA, you can further set the sub ratings to block specific elements of programming. To set the sub ratings, follow the steps below.

- 1** Use [Cursor ▲/▼] to select the desired main rating, then press [ENTER] twice to show its sub ratings.

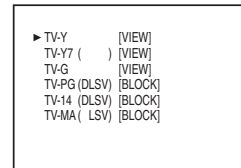

- 2** Use [Cursor ▲/▼], then press [ENTER] repeatedly to change the setting.

e.g.) TV-PG

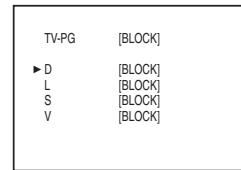

Sub Rating	Category	Rating
FV	Fantasy Violence	TV-Y7
V	Violence	TV-PG
S	Sexual Situation	TV-14
L	Coarse Language	TV-MA
D	Suggestive Dialogue	TV-PG, TV-14

- 6** Press [SETUP] to exit.



Note:

- Blocked sub ratings will appear beside the main rating category in "TV RATING" menu.
- You cannot block a sub rating (D, L, S or V) if the main rating is set to "VIEW".
- Changing the category to "BLOCK" or "VIEW" automatically changes all its sub ratings to the same ("BLOCK" or "VIEW").

B. MPA Rating

MPAA Rating is the rating system created by MPAA (Motion Picture Association of America).

4 Use [Cursor ▲/▼] to select "MPAA RATING", then press [ENTER].

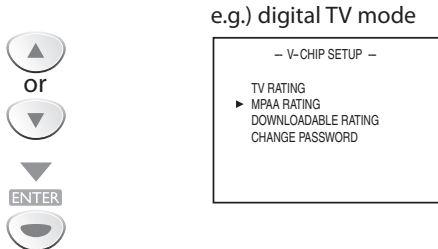

5 Use [Cursor ▲/▼], then press [ENTER] repeatedly to change the setting.

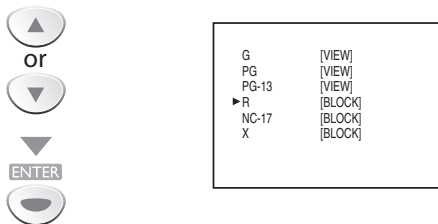

Rating	Category
G	General audience
PG	Parental guidance suggested
PG-13	Unsuitable for children under 13
R	Restricted; under 17 requires accompanying parent or adult guardian
NC-17	No one under 17 admitted
X	Mature audience only

6 Press [SETUP] to exit.



C. Change Password

Although the default code "0000" is supplied with the unit, you can set your own password.

4 Use [Cursor ▲/▼] to select "CHANGE PASSWORD", then press [ENTER].

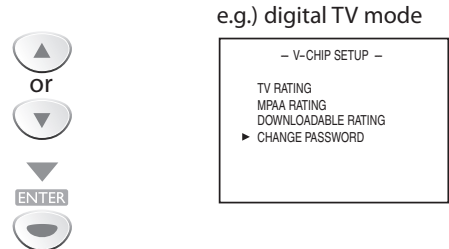

5 Press [the Number buttons] on the remote control to enter the new 4-digit password.

• Enter password again in "CONFIRM PASSWORD" space.

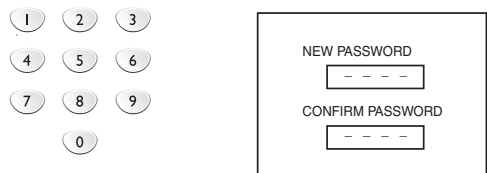

6 Press [SETUP] to exit.



Note:

- Make sure new password and confirm password must be exactly the same. If they are different, the space is cleared for reentering.
- Your password will be erased and return to the default (0000) when a power failure occurs. If you forget the password, unplug the power cord for 10 seconds to restore the password to 0000.

DVD Functions

✓ Playable Media

Type of media	Mark (logo)	Region code	Recorded signals	Media size	Disc types
DVD-video *1, 2, 4, 6, 10, 11			digital video (MPEG2)	5 inches (12 cm)	
DVD-RW DVD-R * 1, 3, 4, 5, 6, 7, 8, 9, 10		—			
DVD+RW DVD+R * 1, 4, 5, 6, 9, 10		—			
audio CD * 4, 6, 10		—	digital audio		
CD-RW CD-R * 4, 5, 6, 9, 10		—			

DVD is a trademark of DVD Format/Logo Licensing Corporation.

If you cannot play back a disc which bears one of the marks above, check the following notes.

- *1: This unit conforms to the NTSC color system. Discs recorded in other color system such as PAL cannot be played back.
- *2: Certain DVD-video does not operate as described in this manual due to the intentions of the disc's producers.
- *3: Discs recorded in VR (video recording) format cannot be played back.
- *4: Scratched or stained discs may not be played back.
- *5: Some discs cannot be played back because of incompatible recording conditions, characteristics of the recorder or special properties of discs.
- *6: You can play back discs which bear the marks above. If you use non-standardized discs, this unit may not play them back. Even if they are played back, the sound or video quality will be compromised.
- *7: You may play back the unfinalized DVD-RW/-R recorded in the video format on our brand's DVD recorder. However, depending on the recording status of a disc, the disc may not be played back at all or normally (the picture or sound may not be smooth, etc.). In this case, you need to finalize the disc with the DVD recorder. Refer to the manual accompanying the DVD recorder.
- *8: Only the discs recorded in the video format and finalized can be played back. Unfinalized discs cannot be played back. Depending on the recording status of a disc, the disc may not be played back at all or the picture or sound may not be smooth, etc.
- *9: If the recorded portion of the disc is too small (less than 2 3/16 inches (55 mm) across), it may not play back properly.
- *10: Do not glue paper or put stickers on to the disc. These may damage the disc, and the unit may not read it correctly.
- *11: The number inside the symbol refer to region of the world and disc encoded in a specific region format can only be played back on unit with the same region cord.

✓ Unplayable Media

- **NEVER play back the following discs. Otherwise, malfunction may result!**
DVD-RAM, DVD-audio, CD-i, photo CD, video CD, DVD with region codes other than 1 or ALL, DTS-CD, DVD-ROM for personal computers, CD-ROM for personal computers, CD-RW/-R with MP3 files.
- **On the following disc, the sound MAY NOT be heard.**
super audio CD

Note:

• Only the sound recorded on the normal CD layer can be delivered. The sound recorded on the high density super audio CD layer cannot be delivered.

- Any other discs without compatibility indications

These operations are accessible by remote control. Some may also be accessible by controls on the main unit.

✓ Playback

Before you begin:

Turn on the amplifier and any other equipment which is connected to this unit. Make sure the external audio receiver are set to the correct input mode.

- 1 Press **[POWER]** to turn on the unit.



- 2 Insert a disc with label facing back from the left side of the unit.

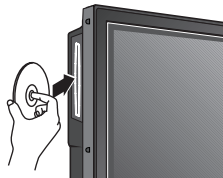

- In case the DVD was recorded on both sides, make sure the label of the side you want to play back is facing back.
- The unit switches to the DVD mode when the unit was in TV mode.

- 3 Press **[PLAY ▶]**. Playback will start.



- If playback does not start automatically, press **[PLAY ▶]** again.

- 4 Press **[STOP ■]** to stop playback temporarily.



- If playback remains stopped for 5 minutes, the screen saver program will activate automatically, when "SCREEN SAVER" is set to "ON".

- 5 Press **[EJECT]** to eject the disc.



Note:

- "⊘" may appear at the top-right on the TV screen when the operation is prohibited by the disc or this unit.
- Some DVD may start playback from title 2 or 3 due to specific programs.
- During the playback of a 2-layered disc, pictures may stop for a moment. This happens while the 1st layer is being switched to the 2nd layer. This is not a malfunction.

✓ DVD Menu

DVD

Some discs contain disc menus which describe the contents of the disc or allow you to customize disc playback, or title menu which lists the titles available on the DVD.

Press **[MENU]** to call up the disc menu.

Use **[Cursor ▲ / ▼ / ◀ / ▶]** to select an item, then press **[ENTER]** (or **[PLAY ▶]**).

Note:

- Menu operations may vary depending on the disc. Refer to the manual accompanying the disc for more details.

✓ Resume Playback

Press **[STOP ■]** during playback. Resume message will appear on the TV screen.

Press **[PLAY ▶]**. Playback will resume from the point at which playback was stopped.

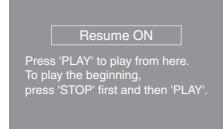

Note:

- To cancel resume, press **[STOP ■]** one more time in the stop mode. On some discs, **[STOP ■]** will not work while the resume message appears. Please wait until the message disappears.
- The resume information will be kept even when unit is turned off. However, ejecting the disc will cancel the resume feature. Playback will start at the beginning the next time you insert the disc.

✓ Pause

Press **[PAUSE ||]** during playback.

- Playback will be paused and sound will be muted.

To continue playback, press **[PLAY ▶]**.

✓ Step-by-step Playback

DVD

Each time you [PAUSE II] in the pause mode, the disc goes forward one frame at a time.



To continue playback, press [PLAY ►].

Note:

• Set "STILL MODE" to "FIELD" in "DISPLAY" menu if pictures in the pause mode are blurred. (Refer to page 38.)

✓ Fast Forward / Fast Reverse

Press and hold [REV ◀◀] or [FWD ▶▶] during playback to select the required forward or reverse speed.



To continue playback, press [PLAY ►].

Note:

- Set "STILL MODE" to "FIELD" in "DISPLAY" menu if pictures in the fast playback mode are blurred. (Refer to page 38.)
- Fast forward / fast reverse speed varies with disc. Approximate speed is 1(2x), 2(8x), 3(20x), 4(50x) and 5(100x) on DVD and 1(2x), 2(8x) and 3(30x) on audio CD.
- For DVD, sound will be muted during the search.
- For audio CD, sound will be intermittent during the search.

✓ Slow Forward / Slow Reverse

DVD

Press and hold [REV ◀◀] or [FWD ▶▶] during the paused mode to select the required forward or reverse speed.



To continue playback, press [PLAY ►].

Note:

- Slow forward / slow reverse speed varies with disc. Approximate speed is 1(1/16x), 2(1/8x) and 3(1/2x).
- Set "STILL MODE" to "FIELD" in "DISPLAY" menu if pictures in the slow playback mode are blurred. (Refer to page 38.)
- The sound will be muted during slow forward/slow reverse playback.

✓ Zoom

DVD

The zoom function allows you to enlarge the video image and to pan through the enlarged image.

- 1 During playback, press [MODE] repeatedly until "OFF (ZOOM)" appears.

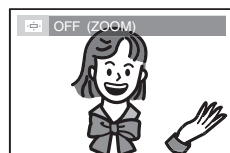

- 2 Press [ENTER] repeatedly to change the zoom factor; "OFF (ZOOM)", "1.3x (ZOOM)", "2x (ZOOM)" or "4x (ZOOM)".

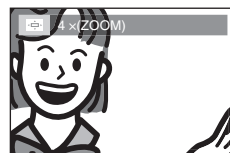

- 3 Once a desired zoom factor is set, press [RETURN] to display the position guide, then use [Cursor ▲/▼/◀/▶] to slide the zoomed picture across the TV screen.

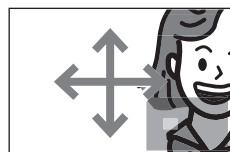
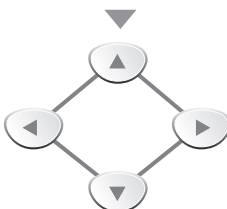

- 4 To exit zoom, repeat steps 1 to 2 above and press [ENTER] until "OFF (ZOOM)" appears.



Note:

- The gray box with an inner blue box that shows during zoomed playback is the position guide indicates the position of the zoomed image within the overall image. Position guide stays on the TV screen until you press [ENTER]. Press [ENTER] one more time to recall the position guide when disappears.
- Zoom function does not work while the disc menu is displayed.
- 4x zoom is not available on some discs.
- Zoom function is also available during pause mode.

✓ Search Functions

Chapter / Title Search

DVD
Using [MODE]

- During playback, press [MODE] repeatedly until "CH" appears.
 - If you want to perform the title search, press [Cursor ▲ / ▼] repeatedly until "TT" appears.



- Press [the Number buttons] to select your desired chapter or title within 60 seconds.

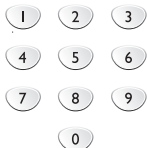

To play back a single-digit chapter or title when there are more than 10 chapters or titles, press [ENTER] after entering the chapter or title number.

- Playback will start automatically from the chapter or title you selected.

Note:

- The total number of chapters/titles in your disc; with less than 10 chapters/titles, press the chapter/title number directly. With 10 or more chapters/titles, to play a single digit chapter/title, press [0] first, then the chapter/title number. (e.g., for chapter 3, press [0] and [3].) To play a double-digit chapter/title, press the chapter/title number.

Using [SKIP] [◀◀] / [▶▶]

- During playback, press [SKIP] [◀◀] / [▶▶] repeatedly until a desired chapter or title will be selected.

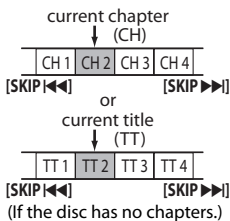

- Playback will start automatically from the chapter or title you selected.

Note:

- [SKIP] [◀◀] / [▶▶] are not available when playback is stopped.
- Chapter/title search can only be performed during playback or when the unit has kept the resume information. It cannot be performed in the stop mode.
- Chapter/title search is not available with some DVD.

Track Search

CD
Using [MODE]

- During playback, press [MODE] repeatedly until "TR" appears.



- Press [the Number buttons] to select your desired track within 60 seconds.

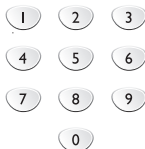

To play back a single-digit track when there are more than 10 tracks, press [ENTER] after entering the track number.

- Playback will start automatically from the track you selected.

Note:

- The total number of tracks in your disc; With less than 10 tracks, press the track number directly. With 10 or more tracks, to play a single digit track, press [0] first, then the track number. (e.g., for track 3, press [0] and [3].) To play a double-digit track, press the track number.
- Track search is not available for programmed or random playback.

Using [SKIP] [◀◀] / [▶▶]

- During playback, press [SKIP] [◀◀] / [▶▶] repeatedly until your desired track will be selected.

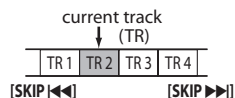

- Playback will start automatically from the track you selected.

Note:

- [SKIP] [◀◀] / [▶▶] are not available when playback is stopped.
- Track search can only be performed during playback or when the unit has kept the resume information. It cannot be performed in the stop mode.

Time Search

- 1 During playback, press **[MODE]** repeatedly until "CH" / "TR" appears.



e.g.) DVD



- 2 Use **[Cursor ▲ / ▼]** repeatedly until "⏮" appears.



or



- 3 Press **[the Number buttons]** to select your desired time lapse within 60 seconds.



- 4 Playback will start automatically from the time you selected.

Note:

- When there is no need to enter a number, "0" appears automatically. For example, "0:0_ :__" appears in time search menu if the total time of the title or track is less than 10 minutes.
- Press **[CLEAR]** to erase the incorrect input at step 3.
- Time search can only be performed during playback or when the unit has kept the resume information. It cannot be performed in the stop mode.

Direct Search

Press **[the Number buttons]** to select your desired chapter, title or track.



Note:

- To select a single-digit chapter, title, track number, press the number directly.
- To select double digit chapter, title, track number:
 - If the disc contains more than 9 and less than 100 chapters, titles, tracks, press **[+10/+100]** first, then enter the double digit chapter, title, track number.
 - (e.g., for track 26, press **[+10/+100]**, **[2]** and **[6]**.)

Repeat Playback

You can repeat playback chapters, titles or tracks on a disc.

- 1 During playback, press **[MODE]** repeatedly until "⏮" appears.



- 2 Press **[Cursor ▲ / ▼]** to change the repeat mode.

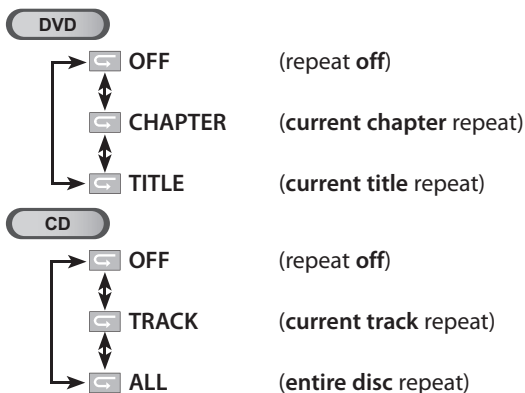

- 3 Press **[RETURN]** to exit.



Repeat A-B Playback

You can repeat playback between A and B on a disc.

- 1 During playback, press **[MODE]** repeatedly until "⏮" OFF" appears.

- 2 Press **[ENTER]** at your desired starting point (A).



- 3 Press **[ENTER]** at your desired ending point (B).



- Point B should be in the same title or track as point A.
- Within a few seconds, the section A-B will begin to play back repeatedly.

- 4 To cancel repeat A-B playback, press **[MODE]** repeatedly until "⏮ A-B" appears. Press **[ENTER]** so "⏮ OFF" appears.



Note:

- Repeat setting (except "ALL") will be cleared when moving to another title, chapter or track.
- During programmed playback, repeat setting will be effective for the tracks in the program.
- Repeat playback or repeat A-B playback may not available with some discs.
- Repeat A-B playback does not function during other repeat mode.
- To cancel point A, press [CLEAR] at step 2 in "Repeat A-B Playback"
- Stopping playback will cancel repeat A-B playback.

Note:

- Press [CLEAR] to erase the last track in the program if you make an error.
- To erase all programmed tracks at once, select "ALL CLEAR" and press [ENTER] at step 2.
- While a program is being played back, [STOP ■] works as follows:
 - Pressing [STOP ■] once: The track will be in the resume standby mode. Next time you press [PLAY ►], the playback will resume from the point where it is stopped in the programmed playback.
 - Pressing [STOP ■] twice: Resume mode will be canceled. Next time you press [PLAY ►], playback will restart from the first track in the original order. However, your programmed playback can be restarted when you follow the above steps. (Your programs are still stored until either the disc is ejected or the unit is turned off.)
- On some discs, [STOP ■] will not work while the resume message appears. Please wait until the message disappears.
- To repeat the current track in the program, follow the steps 1 and 2 in "Repeat Playback" on page 31 and select "TRACK".
- To repeat the entire program, follow the steps 1 and 2 in "Repeat Playback" on page 31 and select "ALL".
- Turning off the unit or ejecting the disc will erase the program.
- You cannot use [the Number buttons] to select another track during programmed playback. Use [SKIP ◀▶] to select other tracks in the program.
- You cannot combine random playback with programmed playback.
- You cannot alter a programmed order during playback.
- You can start programmed playback only while in "PROGRAM" menu.

✓ Programmed Playback



You may determine the order in which tracks will play back.

1 In stop mode, press [MODE] repeatedly until the "PROGRAM" menu appears.

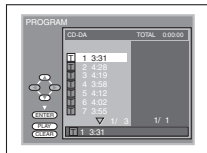

2 Use [Cursor ▲ / ▼] to select a desired track, then press [ENTER] to store.

- Additional tracks may be on other screens. Use [Cursor ▲ / ▼] to go on to the next/previous pages.
- Repeat this step until you have selected all the tracks you wish to play back in the program.

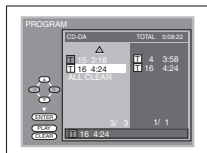

- Up to 99 tracks can be ordered.
- If 8 or more tracks were in a program, use [SKIP ◀▶] to see all the tracks.

3 Press [PLAY ►] to start programmed playback.



✓ Random Playback



This function shuffles the playing order of tracks instead of playback in the sequence.

1 In stop mode, press [MODE] repeatedly until "RANDOM" menu appears.

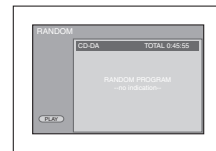

2 Press [PLAY ►] to start random playback.



Note:

- To repeat the current track in the random mode, follow the steps 1 and 2 in "Repeat Playback" on page 31 and select "TRACK".
- To repeat the entire random selections, follow the steps 1 and 2 in "Repeat Playback" on page 31 and select "ALL".
- Random playback will be kept until you press [STOP ■].

✓ On-screen Display

You can check the information about the current disc by pressing [DISPLAY] on the remote control.

DVD

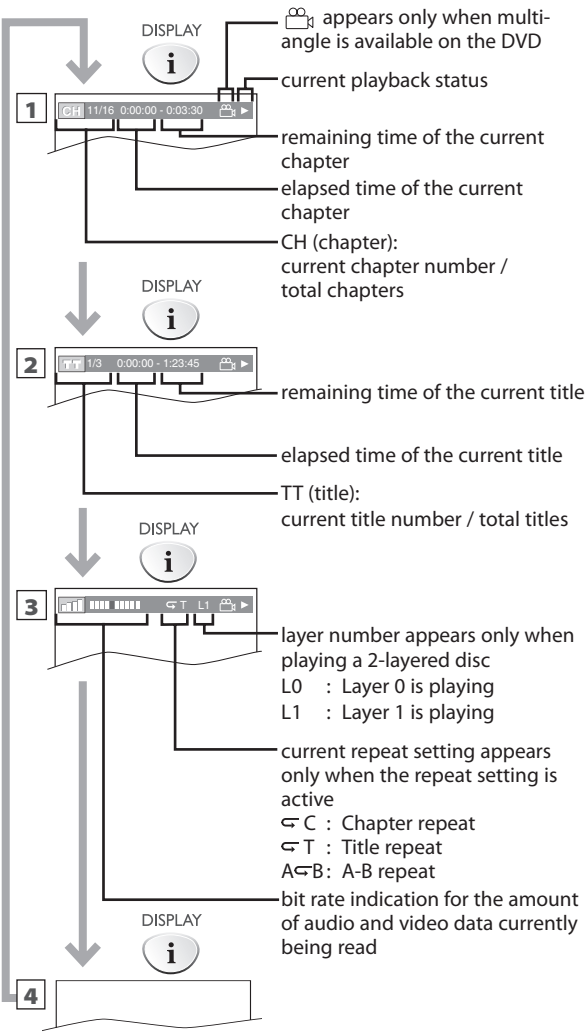

CD

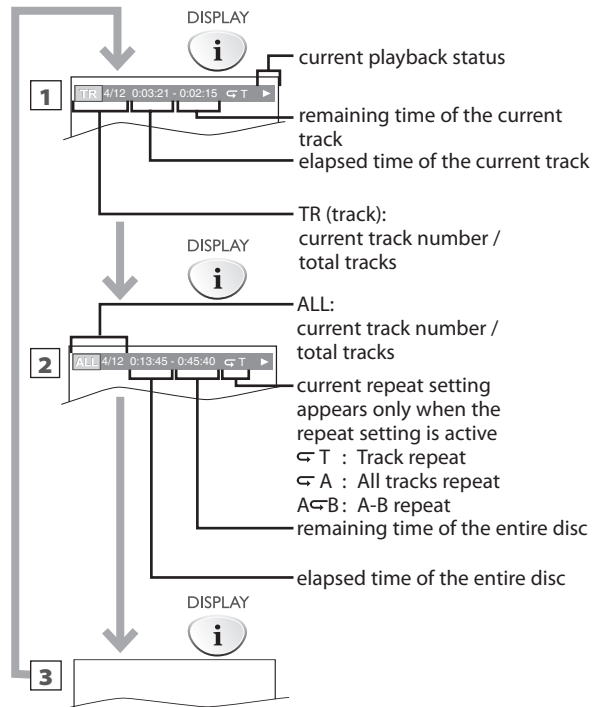

Note:
 • When you are playing a disc in program or random mode, "TR PROGRAM" (or "TR RANDOM") will be displayed instead of [2].

✓ Special Settings

Subtitle Language

DVD

This unit allows you to select a subtitle language (if available) during DVD playback.

- 1 During playback, press **[MODE]** repeatedly until "Ⓜ" appears.



- 2 Use **[Cursor ▲/▼]** repeatedly until your desired language appears.

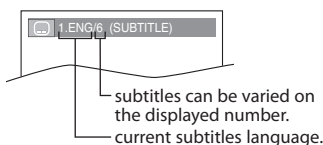

- Each time you press **[Cursor ▲/▼]**, the subtitle language changes as example below.

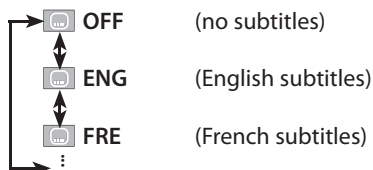

To cancel the subtitle

- 1 During playback, press **[MODE]** repeatedly until "Ⓜ" appears.

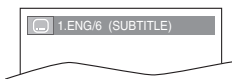

- 2 Use **[Cursor ▲/▼]** repeatedly until "Ⓜ OFF (SUBTITLE)" appears.

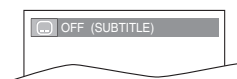

Note:

- If your language is not shown after pressing **[Cursor ▲/▼]** several times, the disc may not have that language. However, some discs only allow you to change subtitle languages setting in the disc menu. (Operation varies depending on the disc, so refer to the manual along with the disc.)
- When "NOT AVAILABLE" appears on the TV screen, it means no subtitle is recorded on the scene.
- If you choose a language that has 3-letter abbreviation, the abbreviation will be displayed every time you change the subtitle language setting. If you choose any other languages, "----" will be displayed instead. (Refer to page 42.)
- Ejecting the disc will cancel your subtitle setting.

Audio Language

DVD

This unit allows you to select an audio language (if multiple languages are available) during DVD playback.

- 1 During playback, press **[AUDIO]** repeatedly until the desired language appears.

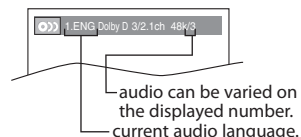

- Each time you press **[AUDIO]**, the audio language changes as example below.

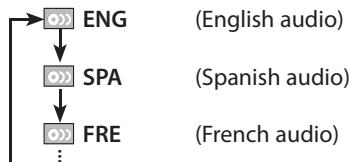

Note:

- Some discs will only allow you to change the audio setting from the disc menu. Refer to the manual accompanying the discs for details.
- If your language is not shown after pressing **[AUDIO]** several times, the disc may not have that language. However, some discs allow you to change multiple audio languages setting in the disc menu. (Operation varies depending on the disc, so refer to the manual along with the disc.)
- When "NOT AVAILABLE" appears on the TV screen, it means audio language is not available.

Camera Angles

DVD

Some DVD may contain scenes which have been shot simultaneously from various angles. You can change the camera angle if "Ⓜ" appears on the TV screen. If "ANGLE ICON" is set to "OFF" in "OTHERS" menu, "Ⓜ" will not appear. (Refer to page 41.)

- 1 During playback, press **[MODE]** repeatedly until "Ⓜ" appears.



- 2 Use **[Cursor ▲/▼]** repeatedly until your desired camera angle appears.

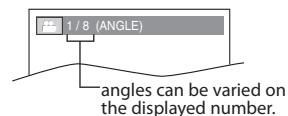

Black Level Setting

DVD

Adjust the black level to make the dark areas of the TV picture brighter.

- 1 During playback, press **[MODE]** repeatedly until "OFF" appears.

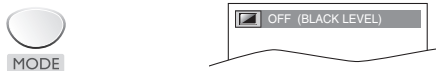

- 2 Use **[Cursor ▲/▼]** to adjust the black level.

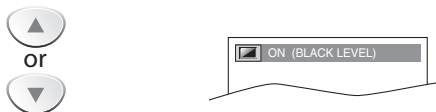

ON : Makes the dark areas brighter.
OFF : Shows the original picture as recorded.

- 3 Press **[RETURN]** to exit.



Note:

- The setting will be kept even if the unit is turned off.

Stereo Sound Mode

CD

This unit allows you to select a sound mode during audio CD playback.

During playback, press **[AUDIO]** repeatedly until the desired sound mode appears.



- Each time you press **[AUDIO]**, the sound mode changes as example below.

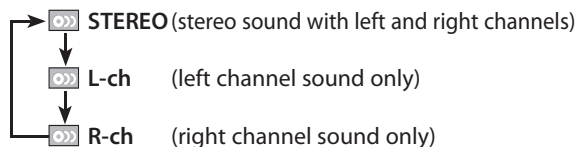

Note:

- Virtual surround cannot be changed when the sound mode is set to either "L-ch" or "R-ch".

Virtual Surround

You can enjoy virtual surround on your existing 2 channel stereo system.

- 1 During playback, press **[MODE]** repeatedly until "OFF" appears.

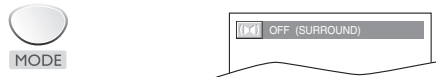

- 2 Use **[Cursor ▲/▼]** to select the sound level.

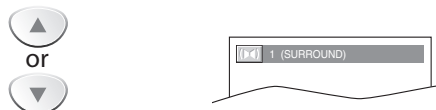

1 : Natural effect
2 : Emphasized effect
OFF : No effects (original sound)

- 3 Press **[RETURN]** to exit.



Note:

- The setting will be kept even if the unit is turned off.
- For audio CD, virtual surround will not be effective if the sound mode is set to something other than "STEREO". See "Stereo Sound Mode".
- Turn down the level or select "OFF" if the sound is distorted.

Marker Setup

This feature allows you to assign a specific point on a disc to be called back later.

To set a marker

- 1 During playback, press **[MODE]** repeatedly until "CH"/"TR" appears.



e.g.) DVD



- 2 Use **[Cursor ▲/▼]** repeatedly until maker search menu appears.



e.g.) DVD

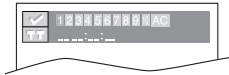

- 3 Use **[Cursor ◀/▶]** to select an available marker within 60 seconds.

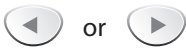

e.g.) DVD

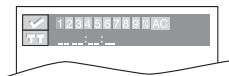

- 4 When the playback reaches the point at which you want to set a marker, press **[ENTER]**.

• Marker is now set.



e.g.) DVD

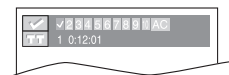

- 5 Press **[RETURN]** to exit.



To return to the marker later

- 1 To select a desired marker, repeat steps 1-3 in "To set a marker".

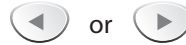

e.g.) DVD

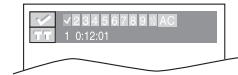

- 2 Press **[ENTER]** at the desired marker to start playback from the specific point which you set.



e.g.) DVD

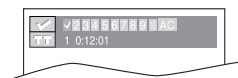

Note:

- Marker Search menu will disappear in about 60 seconds when there is no input.
- You can mark up to 10 points.
- To clear a marker, select the marker to be cleared, and then press **[CLEAR]**.
- Ejecting the disc or turning off the power will erase all markers.
- Selecting "AC" at step 3 in the section "To set a marker" will also erase all markers.

Settings are only effective when the unit is in DVD mode and any discs should not be played back.

QUICK MENU AT A GLANCE

If you make setting for "TV MODE" or "DOLBY DIGITAL", you can also enter from the "QUICK" menu. Use [Cursor ▲/▼] to select "QUICK" and press [ENTER] at step 3.

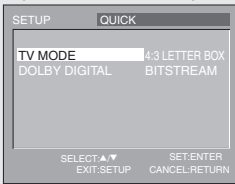

✓ DVD Language Setting

You can change the desired language when playing back the disc.

1 In stop mode, press [SETUP] to display "TV SETUP".

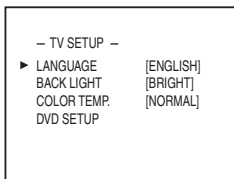

2 Use [Cursor ▲/▼] to select "DVD SETUP"; then press [ENTER].

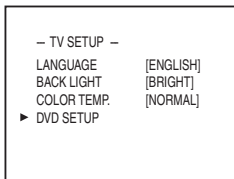

3 Use [Cursor ▲/▼] to select "CUSTOM", then press [ENTER].

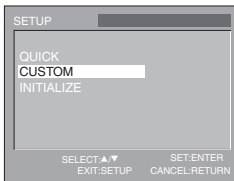

4 Use [Cursor ▲/▼] to select "LANGUAGE"; then press [ENTER].

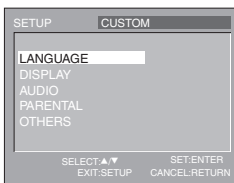

5 Use [Cursor ▲/▼] to select the desired item, then press [ENTER].

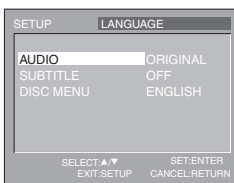

6 Use [Cursor ▲/▼] to select the desired item, then press [ENTER].

[AUDIO] *1, *2 (Default: ORIGINAL)
Select the desired audio language.

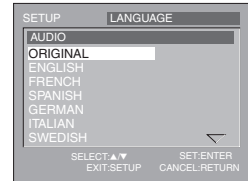

[SUBTITLE] *1, *2 (Default: OFF)
Select the desired subtitle language.

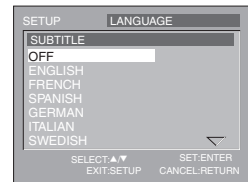

[DISC MENU] *1 (Default: ENGLISH)
Select the desired language in DVD menu.

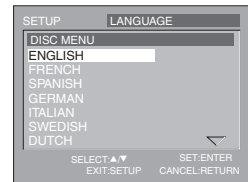

Note:

- To change the on-screen language, call up "TV SETUP" menu by pressing [SETUP] once and set the desired language. (Refer to "Language Selection" on page 15.)

*1

- Language options are not available with some discs.
- If "OTHER" is selected in "AUDIO", "SUBTITLE" or "DISC MENU" menu, press 4-digit number to enter the code for the desired language. (Refer to "Language Code List" on page 42.)
- Only the languages supported by the disc can be selected.

*2

- Use [MODE] to select subtitles available on the DVD.
- Use [AUDIO] to select audio available on the DVD.
- If the DVD's default settings for audio and subtitle are the same language, the subtitles may not show unless you turn them on.

7 Press [SETUP] to exit.



✓ Display Setting

You can change the TV aspect ratio and still mode clarity in "DISPLAY" menu.

1 In stop mode, press [SETUP] to display "TV SETUP".

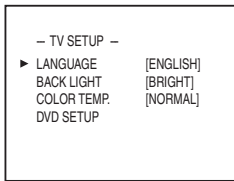

2 Use [Cursor ▲/▼] to select "DVD SETUP", then press [ENTER].

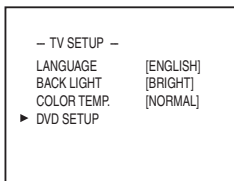

3 Use [Cursor ▲/▼] to select "CUSTOM", then press [ENTER].

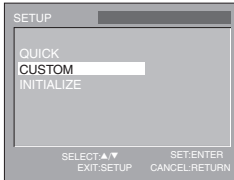

4 Use [Cursor ▲/▼] to select "DISPLAY", then press [ENTER].

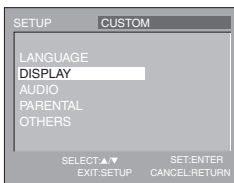

5 Use [Cursor ▲/▼] to select the desired item, then press [ENTER].

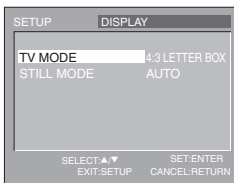

6 Use [Cursor ▲/▼] to select the desired item, then press [ENTER].

[TV MODE]

(Default: 4:3 LETTER BOX)

Select the desired TV aspect ratio.

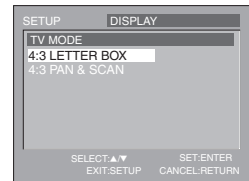

[STILL MODE]

(Default: AUTO)

Select the desired still mode.

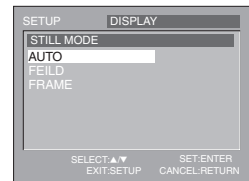

Note:

TV MODE:

- Select "4:3 LETTER BOX", so that black bars may appear on the top and bottom of the TV screen.
- Select "4:3 PAN & SCAN" for a full height picture with both sides adjusted.

STILL MODE:

- Select "AUTO" usually.
- If you select "FIELD", the picture in the still mode will be stabilized.
- If you select "FRAME", the picture in the still mode will be highly defined.

7 Press [SETUP] to exit.



✓ DVD Audio Setting

Choose the appropriate audio settings for your equipment. It only affects during the playback of DVD.

1 In stop mode, press [SETUP] to display "TV SETUP".

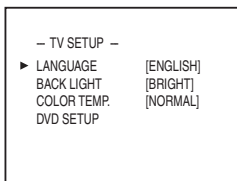

2 Use [Cursor ▲/▼] to select "DVD SETUP", then press [ENTER].

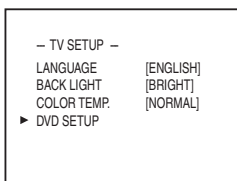

3 Use [Cursor ▲/▼] to select "CUSTOM", then press [ENTER].

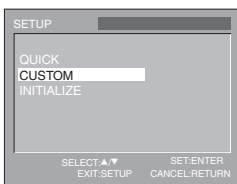

4 Use [Cursor ▲/▼] to select "AUDIO", then press [ENTER].

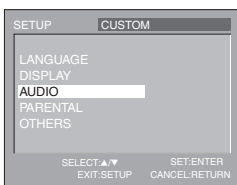

5 Use [Cursor ▲/▼] to select the desired item, then press [ENTER].

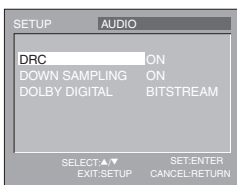

6 Use [Cursor ▲/▼] to select the desired item, then press [ENTER].

[DRC] (dynamic range control) (Default: ON)
 Set "DRC".

This function is available only on the discs which are recorded in the Dolby Digital format.

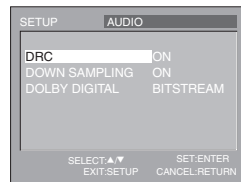

ON : Compress the range between soft and loud sounds.

OFF : No effects (original sound).

[DOWN SAMPLING] (Default: ON)

Set "DOWN SAMPLING".

This function is available only on digital outputting of a disc recorded in 96kHz.

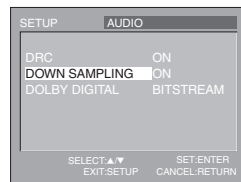

ON : When outputting in 48kHz.

OFF : When outputting the original sound.

Note:

• When playing back a 96 kHz disc with the copyright protection or when virtual surround is set to 1 or 2, the sound will be down sampled at 48 kHz even if "DOWN SAMPLING" is "OFF".

[DOLBY DIGITAL] (Default: BITSTREAM)

Set "BITSTREAM" when this unit is connected to a Dolby Digital decoder. Available on DVD only.

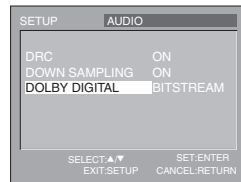

BITSTREAM : Outputs Dolby Digital signals.

PCM : Converts the Dolby Digital into PCM. (2 channel)

7 Press [SETUP] to exit.



✓ Parental Setting

Parental setting prevents your children from viewing inappropriate materials. (password protected.) Playback will stop if the ratings exceed the levels you set.

1 In stop mode, press **[SETUP]** to display "TV SETUP".

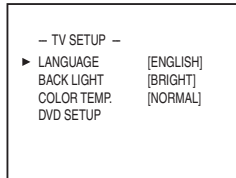

2 Use **[Cursor ▲/▼]** to select "DVD SETUP", then press **[ENTER]**.

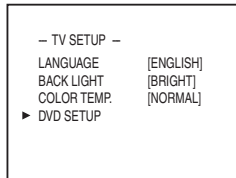

3 Use **[Cursor ▲/▼]** to select "CUSTOM", then press **[ENTER]**.

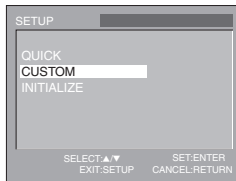

4 Use **[Cursor ▲/▼]** to select "PARENTAL", then press **[ENTER]**.

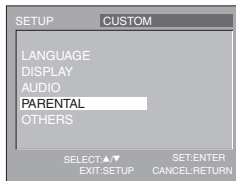

5 Use **[the Number buttons]** to enter the 4-digit number for your password, then press **[ENTER]**.

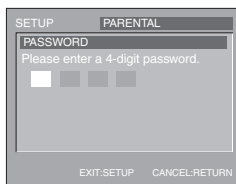

- If you have set password already, use **[the Number buttons]** to enter the current 4-digit password.
- You cannot use the default password (4737) to play a DVD.

6 Use **[Cursor ▲/▼]** to select "PARENTAL LEVEL", then press **[ENTER]**.

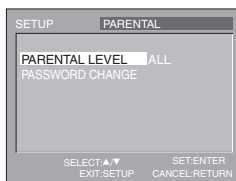

7 Use **[Cursor ▲/▼]** to select the desired item, then press **[ENTER]**.

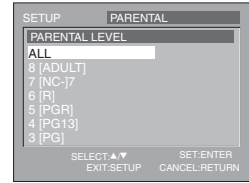

PARENTAL LEVEL

- ALL** : all parental locks are canceled.
- 8 [ADULT]** : all ratings (adult/general/children) can be played back.
- 7 [NC-17]-2 [G]** : only DVD intended for general use and children can be played back.
- 1 [KID SAFE]** : only DVD intended for children can be played back.

8 Press **[SETUP]** to exit.



To change the password

6 Follow steps 1 to 4. Use **[Cursor ▲/▼]** to select "PASSWORD CHANGE", then press **[ENTER]**.

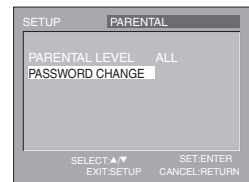

7 Use **[the Number buttons]** to enter the new 4-digit password, then press **[ENTER]**.

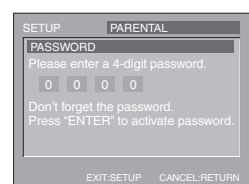

Note:

- DVD-video may not respond to parental lock settings. Make sure this function works with your DVD-video.
- Record the password in case you forget it.
- If you forget the password, press **[4]**, **[7]**, **[3]**, **[7]**, then enter your new password. Password will be cleared and parental levels will be set to "ALL".
- A power failure will not erase your password.

8 Press **[SETUP]** to exit.



Others

You can change the other functions.

1 In stop mode, press [SETUP] to display "TV SETUP".

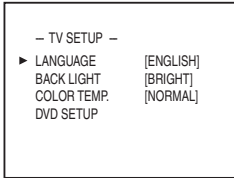

2 Use [Cursor ▲/▼] to select "DVD SETUP", then press [ENTER].

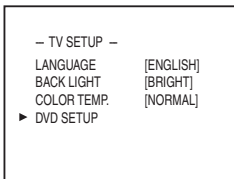

3 Use [Cursor ▲/▼] to select "CUSTOM", then press [ENTER].

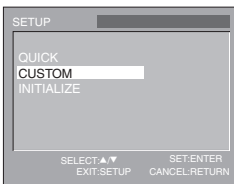

4 Use [Cursor ▲/▼] to select "OTHERS", then press [ENTER].

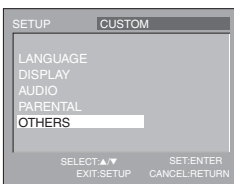

5 Use [Cursor ▲/▼] to select the desired item, then press [ENTER].

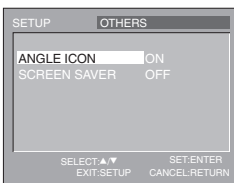

6 Use [Cursor ▲/▼] to select the desired item, then press [ENTER].

[ANGLE ICON] (Default: ON)
Set to "ON" to show the angle icon when multiple camera angles are available during DVD playback.

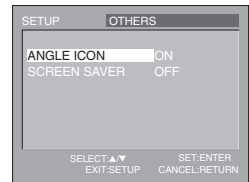

[SCREEN SAVER] (Default: OFF)
If you select "ON", the screen saver program starts when there is no input from the unit for 5 minutes in stop mode.

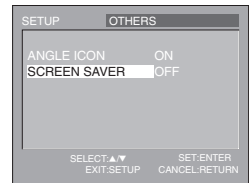

7 Press [SETUP] to exit.



✓ Reset to the Default Setting

You can reset all the settings except for the parental setting and on-screen menu language.

1 In stop mode, press **[SETUP]** to display "TV SETUP".

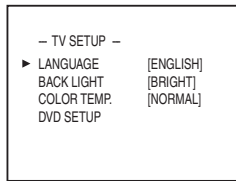

2 Use **[Cursor ▲/▼]** to select "DVD SETUP", then press **[ENTER]**.

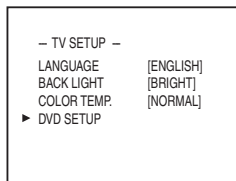

3 Use **[Cursor ▲/▼]** to select "INITIALIZE", then press **[ENTER]**.

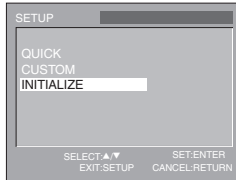

4 Use **[Cursor ▲/▼]** to select "YES", then press **[ENTER]**.

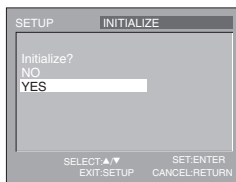

Note:

• When you want to cancel the initialization, select "NO" at step 4, then press **[SETUP]**.

5 Press **[SETUP]** to exit.



✓ Language Code List

Language	A-B	Code	Language	Code
Abkhazian		4748	Marathi	5964
Afar		4747	Moldavian	5961
Afrikaans		4752	Mongolian	5960
Albanian		6563	Nauru	6047
Amharic		4759	Nepali	6051
Arabic		4764	Norwegian [NOR]	6061
Armenian		5471		O-R
Assamese		4765	Occitan	6149
Aymara		4771	Oriya	6164
Azerbaijani		4772	Oromo(Afan)	6159
Bashkir		4847	Panjabi	6247
Basque		5167	Pashto; Pushto	6265
Bengali; Bangla		4860	Persian	5247
Bhutani		5072	Polish [POL]	6258
Bihari		4854	Portuguese [POR]	6266
Bislama		4855	Quechua	6367
Breton		4864	Rhaeto-Romance	6459
Bulgarian		4853	Romanian [RUM]	6461
Burmese		5971	Russian [RUS]	6467
Byelorussian		4851		S
	C-E		Samoan	6559
Cambodian		5759	Sangho	6553
Catalan		4947	Sanskrit	6547
Chinese [CHI]		7254	Scots Gaelic	5350
Corsican		4961	Serbian	6564
Croatian		5464	Serbo-Croatian	6554
Czech [CZE]		4965	Sesotho	6566
Danish [DAN]		5047	Setswana	6660
Dutch [DUT]		6058	Shona	6560
English [ENG]		5160	Sindhi	6550
Esperanto		5161	Singhalese	6555
Estonian		5166	Siswat	6565
	F-H		Slovak	6557
Faroese		5261	Slovenian	6558
Fiji		5256	Somali	6561
Finnish [FIN]		5255	Spanish [SPA]	5165
French [FRE]		5264	Sundanese	6567
Frisian		5271	Swahili	6569
Galician		5358	Swedish [SWE]	6568
Georgian		5747		T
German [GER]		5051	Tagalog	6658
Greek [GRE]		5158	Tajik	6653
Greenlandic		5758	Tamil	6647
Guarani		5360	Tatar	6666
Gujarati		5367	Telugu	6651
Hausa		5447	Thai	6654
Hebrew		5569	Tibetan	4861
Hindi		5455	Tigrinya	6655
Hungarian [HUN]		5467	Tonga	6661
	I-K		Tsonga	6665
Icelandic [ICE]		5565	Turkish [TUR]	6664
Indonesian		5560	Turkmen	6657
Interlingua		5547	Twi	6669
Interlingue		5551		U-Z
Inupiak		5557	Ukrainian	6757
Irish [IRI]		5347	Urdu	6764
Italian [ITA]		5566	Uzbek	6772
Japanese [JPN]		5647	Vietnamese	6855
Javanese		5669	Volapuk	6861
Kannada		5760	Welsh	4971
Kashmiri		5765	Wolof	6961
Kazakh		5757	Xhosa	7054
Kinyarwanda		6469	Yiddish	5655
Kirghiz		5771	Yoruba	7161
Kirundi		6460	Zulu	7267
Korean [KOR]		5761		
Kurdish		5767		
	L-N			
Laothian		5861		
Latin		5847		
Latvian; Lettish		5868		
Lingala		5860		
Lithuanian		5866		
Macedonian		5957		
Malagasy		5953		
Malay		5965		
Malayalam		5958		
Maltese		5966		
Maori		5955		

Note:

• If you choose a language that has a 3-letter abbreviation, they will be displayed every time you change the audio or subtitle language setting above. If you choose any other language, "--" will be displayed instead. (3-letter abbreviation is written in bracket.)

✓ Troubleshooting Guide

If the unit does not perform properly when operated as instructed in this owner's manual, check the following chart once before calling for service.

Symptom	Remedy
No power	<ul style="list-style-type: none"> • Be sure the power cord is plugged in. • If a power failure occurs, unplug the power cord for 30 minutes to allow the unit to reset itself.
No picture or sound	<ul style="list-style-type: none"> • Check if the power is on. • Check the outlet connection. • Check the antenna or cable connection to the main unit. • When the outside antenna is used, check the wire condition and connection. • View other TV channels. The problem might be limited to the broadcasting station. • Turn off the power and wait for about 1 minute, then turn it on again.
No color	<ul style="list-style-type: none"> • Check the antenna or cable connection to the main unit. • When the outside antenna is used, check the wire condition and connection. • View other TV channels. The problem might be limited to the broadcasting station. • Adjust the "COLOR" in the main menu.
Sound OK, picture poor	<ul style="list-style-type: none"> • Check the antenna or cable connection to the main unit. • When the outside antenna is used, check the wire condition and connection. • Electrical interference from nearby appliances may affect picture quality. • Adjust "CONTRAST" and "BRIGHTNESS" in the main menu. • View other TV channels. The problem might be limited to the broadcasting station.
Picture distorted	<ul style="list-style-type: none"> • When the outside antenna is used, check the wire condition and connection. • View other TV channels. The problem might be limited to the broadcasting station.
Weak picture	<ul style="list-style-type: none"> • Check the antenna or cable connection to the main unit. • When the outside antenna is used, check the wire condition and connection. • Adjust "CONTRAST" and "BRIGHTNESS" in the main menu. • View other TV channels. The problem might be limited to the broadcasting station.
Lines or streaks in picture	<ul style="list-style-type: none"> • When the outside antenna is used, check the wire condition and connection. • Electrical interference from nearby appliances may affect picture quality. • View other TV channels. The problem might be limited to the broadcasting station.
Picture blurred	<ul style="list-style-type: none"> • When the outside antenna is used, check the wire condition and connection. • View other TV channels. The problem might be limited to the broadcasting station.
Ghosts in picture	<ul style="list-style-type: none"> • Check the antenna or cable connection to the main unit. • When the outside antenna is used, check the wire condition and connection. • Electrical interference from nearby appliances may affect picture quality. • View other TV channels. The problem might be limited to the broadcasting station.
Bars on screen	<ul style="list-style-type: none"> • When the outside antenna is used, check the wire condition and connection. • Electrical interference from nearby appliances may affect picture quality.
Picture rolls vertically	<ul style="list-style-type: none"> • When the outside antenna is used, check the wire condition and connection. • Electrical interference from nearby appliances may affect picture quality. • View other TV channels. The problem might be limited to the broadcasting station.
Different color marks on screen	<ul style="list-style-type: none"> • Move the unit away from nearby electric appliances. Turn off the power and wait 30 minutes before turning it back on. • View other TV channels. The problem might be limited to the broadcasting station.
Poor reception on some channels	<ul style="list-style-type: none"> • Check the antenna or cable connection to the main unit. • When the outside antenna is used, check the wire condition and connection. • Electrical interference from nearby appliances may affect picture quality. • View other TV channels. The problem might be limited to the broadcasting station.
Picture OK, sound poor	<ul style="list-style-type: none"> • View other TV channels. The problem might be limited to the broadcasting station.
No reception of digital signals	<ul style="list-style-type: none"> • Make sure auto channel scan has been completed (Refer to "Auto Channel Scan" on page 14). Auto channel scan must be completed when you set up the unit for the first time or move it to a location where previously unavailable channels are broadcast. • The selected channel may not be broadcasting. • When auto channel scan is interrupted and not completed, some channels will not be received. Make sure to complete (Refer to "Auto Channel Scan" on page 14).

	Symptom	Remedy
	The entered channel number changes automatically	<ul style="list-style-type: none"> • Many digital channels have alternate channel numbers. The unit changes the numbers automatically to the ones signifying the broadcasting stations. These are the numbers used for analog broadcasts.
	Remote control does not work	<ul style="list-style-type: none"> • Check the antenna or cable connection to the main unit. • Check the batteries of the remote control. • Check if there is an obstacle between the infrared sensor window and the remote control. • Test the signal output. If OK, then possible remote sensor trouble. (Refer to "IR Signal Check" on page 45.) • Aim the remote control directly at the infrared sensor window on the front of the unit. • Reduce the distance to the unit. • Re-insert the batteries with their polarities (+/- signs) as indicated.
	Problems with Closed Caption Feature	
T	Misspelled captions are displayed.	<ul style="list-style-type: none"> • Closed captioning production companies may broadcast programs without correcting the misspelling in a live broadcast.
V	Captions are not entirely displayed, or captions are delayed behind the dialogue.	<ul style="list-style-type: none"> • Captions that are delayed a few seconds behind the actual dialogue are common for live broadcasts. Most captioning production companies can display a dialogue to a maximum of 220 words per minute. If a dialogue exceeds that rate, selective editing is used to insure that the captions remain up-to-date with the current TV screen dialogue.
	Captions are displayed as a white box. No caption is displayed in the Closed Caption-supported program.	<ul style="list-style-type: none"> • Interference from buildings or weather conditions may cause captioning to be incomplete. • Broadcasting station may shorten the program to insert advertisement. The closed caption decoder cannot read the information of the shortened program.
	No caption is displayed when playing the videotape containing captions.	<ul style="list-style-type: none"> • The videotape may be illegally copied, or the caption signal might not have been read during copying.
	Black box is displayed in the screen.	<ul style="list-style-type: none"> • "Text" mode is selected for caption. Select "CAPTION1", "CAPTION2" or "OFF".
	Completely distorted picture or black/white picture with DVD	<ul style="list-style-type: none"> • Make sure the disc is compatible with the unit.
	Picture freezes momentarily during playback.	<ul style="list-style-type: none"> • Check the disc for finger prints/scratches and clean with a soft cloth wiping from center to edge.
D	Disc cannot be played.	<ul style="list-style-type: none"> • Clean the disc. • Ensure the disc is correctly inserted. • Check if the disc is defective by trying another disc. • Cancel the parental lock or change the control level. • Insert a correct disc that plays on this unit. • Handle a disc with special care so that it does not have fingerprints, scratches, or dusts on its surface.
V	Buttons do not work or the unit stops responding.	<ul style="list-style-type: none"> • To completely reset the unit, unplug the power cord from the power outlet for 5-10 seconds.
D	The unit does not respond to some operating commands during playback.	<ul style="list-style-type: none"> • Operations may not be permitted by the disc. Refer to the instructions of the disc.
	Angle does not switch.	<ul style="list-style-type: none"> • The angle cannot be switched for DVD which do not contain multiple angles. In some cases multiple angles are only recorded for specific scenes.
	Playback does not start when the title is selected.	<ul style="list-style-type: none"> • Check the "PARENTAL" setting.
	The password for rating level has been forgotten.	<ul style="list-style-type: none"> • Enter the default password "4737", then your forgotten password will be cleared.

Note:

- The LCD panel is manufactured to provide many years of useful life. Occasionally a few non active pixels may appear as a fixed point of blue, green or red. This is not to be considered a defect in the LCD screen.
- Some functions are not available in specific modes, but this is not a malfunction. Read the description in this owner's manual for more details on correct operations.
- Playback from a desired track and random playback are not available during program playback.
- Some functions are prohibited on some discs.

✓ Glossary

ATSC

Acronym that stands for Advanced Television Systems Committee and the name of the digital broadcasting standards.

Aspect ratio

The width of a TV screen relative to its height. Conventional TVs are 4:3 (in other words, the screen is almost square); widescreen models are 16:9 (the screen is almost twice as wide as its height).

Component Video

This is a video signal format that conveys each of 3 principal colors of light (red, blue and green) through different signal lines. This allows the viewers to experience picture colors as original as it is. There are several signal formats, including Y / Pb / Pr and Y / Cb / Cr.

Dolby Digital

The system developed by Dolby Laboratories to compress digital sound. It offers stereo sound (2ch) or multi-channel audio.

HDTV (high definition TV)

Ultimate digital format that produces high resolution and high picture quality.

NTSC

Acronym that stands for National Television Systems Committee and the name of the current analog broadcasting standards.

Password

A stored 4-digit number that allows access to parental control features.

Region Code

Regions associate discs and players with particular areas of the world. This unit will only play back discs that have compatible region codes. You can find the region code of your unit by looking on the rear panel. Some discs are compatible with more than one region (or all regions).

SAP (secondary audio program)

Second-audio channel delivered separately from main-audio channel. This audio channel is used as an alternate in bilingual broadcasting.

SDTV (standard definition TV)

Standard digital format that is similar to the NTSC picture quality.

S-video

Offers higher quality images by delivering each signal, color (c) and luminance (y) independently of each other through separate cables.

✓ Maintenance

Cabinet Cleaning

- Wipe the front panel and other exterior surfaces of the unit with a soft cloth immersed in lukewarm water and wrung dry.
- Never use a solvent or alcohol. Do not spray insecticide liquid near the unit. Such chemicals may cause damage and discoloration to the exposed surfaces.

Servicing

Should your unit become inoperative, do not try to correct the problem yourself. There are no user serviceable parts inside. Turn off the unit, unplug the power cord and call our toll free customer support line found on the cover of this manual to locate an authorized service center.

Panel Cleaning

Wipe the panel with a soft cloth. Before cleaning the panel, disconnect the power cord.

If the Laser Optical Pickup Unit is Dirty

- If the unit still does not perform properly when it is operated, while referring to the relevant sections and to "Troubleshooting Guide" in this owner's manual, the laser optical pickup unit may be dirty. Consult your dealer or an Authorized Service Center for inspection and cleaning of the laser optical pickup unit.

Disc Handling

- Handle the discs so that fingerprints and dust do not adhere to the surfaces of the discs.



- Always store the disc in its protective case when it is not used.
- To clean-off, use a soft cloth.
- Do not use a hard cloth since this will mar the disc.
- Wipe the disc in a straight line from center to edge.
- Never wipe with a circular motion.



- Do not use detergent or abrasive cleaning agents.

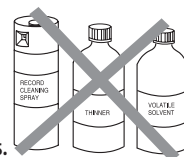

IR Signal Check

If the remote control is not working properly, you can use an AM radio or digital camera (including a cellular phone with built-in camera) to see if it is sending out an infrared signal.

- With an AM radio: Tune the AM radio station to a non-broadcasting frequency. Point the remote control towards it, push any button and listen. If the sound from the radio flutters, it is receiving the remote control's infrared signal.

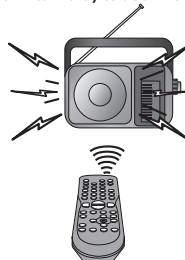

- With a digital camera (including built-in cell phone cameras) Point a digital camera towards the remote control. Push any button on the remote control and look through the digital camera. If the infrared light appears through the camera, the remote control is working.

✓ Cable Channel Designations

If you subscribe to cable TV, the channels are displayed as 1-135. Cable companies often designate channels with letters or letter-number combinations. Please check with your local cable company. The following is a chart of common cable channel designations.

CATV channel	5A	2	3	4	5	6	7	8	9	10	11	12	13	A	B	C	D	E	F	G	H
TV Display	1	2	3	4	5	6	7	8	9	10	11	12	13	14	15	16	17	18	19	20	21
CATV channel	I	J	K	L	M	N	O	P	Q	R	S	T	U	V	W	W+1	W+2	W+3	W+4	W+5	W+6
TV Display	22	23	24	25	26	27	28	29	30	31	32	33	34	35	36	37	38	39	40	41	42
CATV channel	W+7	W+8	W+9	W+10	W+11	W+12	W+13	W+14	W+15	W+16	W+17	W+18	W+19	W+20	W+21	W+22	W+23	W+24	W+25	W+26	W+27
TV Display	43	44	45	46	47	48	49	50	51	52	53	54	55	56	57	58	59	60	61	62	63
CATV channel	W+28	W+29	W+30	W+31	W+32	W+33	W+34	W+35	W+36	W+37	W+38	W+39	W+40	W+41	W+42	W+43	W+44	W+45	W+46	W+47	W+48
TV Display	64	65	66	67	68	69	70	71	72	73	74	75	76	77	78	79	80	81	82	83	84
CATV channel	W+49	W+50	W+51	W+52	W+53	W+54	W+55	W+56	W+57	W+58	A-5	A-4	A-3	A-2	A-1	W+59	W+60	W+61	W+62	W+63	W+64
TV Display	85	86	87	88	89	90	91	92	93	94	95	96	97	98	99	100	101	102	103	104	105
CATV channel	W+65	W+66	W+67	W+68	W+69	W+70	W+71	W+72	W+73	W+74	W+75	W+76	W+77	W+78	W+79	W+80	W+81	W+82	W+83	W+84	W+85
TV Display	106	107	108	109	110	111	112	113	114	115	116	117	118	119	120	121	122	123	124	125	126
CATV channel	W+86	W+87	W+88	W+89	W+90	W+91	W+92	W+93	W+94												
TV Display	127	128	129	130	131	132	133	134	135												

✓ General Specifications

TV

Television Format: ATSC / NTSC-M TV Standard

Closed caption system:

\$15.122/FCC (Digital CC)

\$15.119/FCC (Analog CC)

Channel coverage (ATSC/NTSC):

VHF: 2 ~ 13

UHF: 14 ~ 69

CATV: 2 ~ 13, A ~ W, W+1 ~ W+94,
(analog W+1 ~ W+84), A-5 ~ A-1, 5A

Tuning system:

Channel frequency
synthesized tuning system

Channel access:

Direct access keyboard,
Programmable scan, and up/down

DVD

Discs (playback compatibility):

DVD video, DVD-RW/-R,
DVD+RW/+R, audio CD, CD-RW/-R

Frequency response:

DVD (linear sound): 20 Hz to 20 kHz (sample rate: 48 kHz)

20 Hz to 44 kHz (sample rate: 96 kHz)

CD: 20 Hz to 20 kHz

Signal-to-noise ratio (S/N ratio):

CD: 75 dB (JEITA)

Total distortion factor:

DVD: 1 kHz 0.008% (JEITA)

CD: 1 kHz 0.008% (JEITA)

✓ Electrical Specification

Sound output: 1W, 8Ω x 2

✓ Other Specifications

Terminals:

Antenna input: VHF/UHF/CATV
75Ω unbalanced (F-type)

Video input: RCA jack x 1 1Vp-p (75Ω)

Audio input: RCA jack x 4 2V rms
(input impedance: more than 22kΩ)

S-Video input: Mini DIN 4-pin jack x 1 Y: 1Vp-p (75Ω)
C: 286mVp-p (75Ω)

Component video input:

RCA jack x 3
Y: 1Vp-p (75Ω)
Pb: 700mVp-p (75Ω)
Pr: 700mVp-p (75Ω)

Digital audio coaxial output:

RCA jack x 1: 500mVp-p (75Ω)

Headphone: 1/8 inches (3.5mm)

Remote control:

Digital encoded
infrared light system

Operating temperature:

41°F (5°C) to 104°F (40°C)

Power requirements: 120 V AC +/- 10%, 60 Hz +/- 0.5%

Power consumption (Maximum):

44W

LCD:

15 inches

Dimensions:

H : 14.3 inches (362mm)

W : 18.6 inches (470mm)

D : 6.5 inches (165mm)

Weight:

10.0 lbs. (4.5 kg)

- Designs and specifications are subject to change without notice and without our legal obligation.
- If there is a discrepancy between languages, the default language will be English.



SYLVANIA

LIMITED WARRANTY

FUNAI CORP. will repair this product, free of charge in the USA in the event of defect in materials or workmanship as follows:

DURATION:

PARTS: FUNAI CORP. will provide parts to replace defective parts without charge for one (1) year from the date of original retail purchase. Certain parts and LCD image burn-in are excluded from this warranty.

LABOR: FUNAI CORP. will provide the labor without charge for a period of ninety (90) days from the date of original retail purchase.

LIMITS AND EXCLUSIONS:

THIS WARRANTY IS EXTENDED ONLY TO THE ORIGINAL RETAIL PURCHASER. A PURCHASE RECEIPT OR OTHER PROOF OF ORIGINAL RETAIL PURCHASE WILL BE REQUIRED TOGETHER WITH THE PRODUCT TO OBTAIN SERVICE UNDER THIS WARRANTY.

This warranty shall not be extended to any other person or transferee.

This warranty is void and of no effect if any serial numbers on the product are altered, replaced, defaced, missing or if service was attempted by an unauthorized service center. This limited warranty does not apply to any product not purchased and used in the United States.

This warranty only covers failures due to defects in material or workmanship which occur during normal use. It does not cover damage which occurs in shipment, or failures which are caused by repairs, alterations or products not supplied by FUNAI CORP., or damage, which results from accident, misuse, abuse, mishandling, misapplication, alteration, faulty installation, improper maintenance, commercial use such as hotel, rental or office use of this product, or damage which results from fire, flood, lightning or other acts of God.

THIS WARRANTY DOES NOT COVER PACKING MATERIALS, ANY ACCESSORIES (EXCEPT REMOTE CONTROL), ANY COSMETIC PARTS, COMPLETE ASSEMBLY PARTS, DEMO OR FLOOR MODELS.

FUNAI CORP. AND ITS REPRESENTATIVES OR AGENTS SHALL IN NO EVENT BE LIABLE FOR ANY GENERAL, INDIRECT OR CONSEQUENTIAL DAMAGES ARISING OUT OF OR OCCASIONED BY THE USE OF OR THE INABILITY TO USE THIS PRODUCT. THIS WARRANTY IS MADE IN LIEU OF ALL OTHER WARRANTIES, EXPRESS OR IMPLIED, AND OF ALL OTHER LIABILITIES ON THE PART OF FUNAI, ALL OTHER WARRANTIES INCLUDING THE WARRANTY OF MERCHANTABILITY AND FITNESS FOR A PARTICULAR PURPOSE, ARE HEREBY DISCLAIMED BY FUNAI AND ITS REPRESENTATIVES IN THE UNITED STATES.

ALL WARRANTY INSPECTIONS AND REPAIRS MUST BE PERFORMED BY AN AUTHORIZED SERVICE CENTER. THIS WARRANTY IS ONLY VALID WHEN THE UNIT IS CARRIED-IN TO AN AUTHORIZED SERVICE CENTER.

THE PRODUCT MUST BE ACCOMPANIED BY A COPY OF THE ORIGINAL RETAIL PURCHASE RECEIPT. IF NO PROOF OF PURCHASE IS ATTACHED, THE WARRANTY WILL NOT BE HONORED AND REPAIR COSTS WILL BE CHARGED.

IMPORTANT:

THIS LIMITED WARRANTY GIVES YOU SPECIFIC LEGAL RIGHTS. YOU MAY HAVE OTHER RIGHTS THAT VARY FROM STATE TO STATE. IF, AT ANY TIME DURING THE WARRANTY PERIOD, YOU ARE UNABLE TO OBTAIN SATISFACTION WITH THE REPAIR OF THIS PRODUCT, PLEASE CONTACT FUNAI CORP.

ATTENTION:

FUNAI CORP. RESERVES THE RIGHT TO MODIFY ANY DESIGN OF THIS PRODUCT WITHOUT PRIOR NOTICE.

WARRANTY STATEMENT REGARDING NON AUTHORIZED REPAIRS:

To obtain warranty service, you must take the product, or deliver the product freight prepaid, in either its original packaging or packaging affording an equal degree of protection, to any AUTHORIZED SERVICE CENTER. FUNAI CORP. will not reimburse you for any service done by unauthorized service providers without prior written approval.

To locate your nearest AUTHORIZED SERVICE CENTER or for general service inquiries, please contact us at:

FUNAI CORPORATION
Customer Service

Tel : 1-800-968-3429

<http://www.SylvaniaConsumerElectronics.com>

19900 Van Ness Avenue, Torrance, CA 90501