

**OWNER'S
MANUAL**

SYLVANIA

**13-INCH COLOR TV/VCR
L13TRG
WLTR13G**

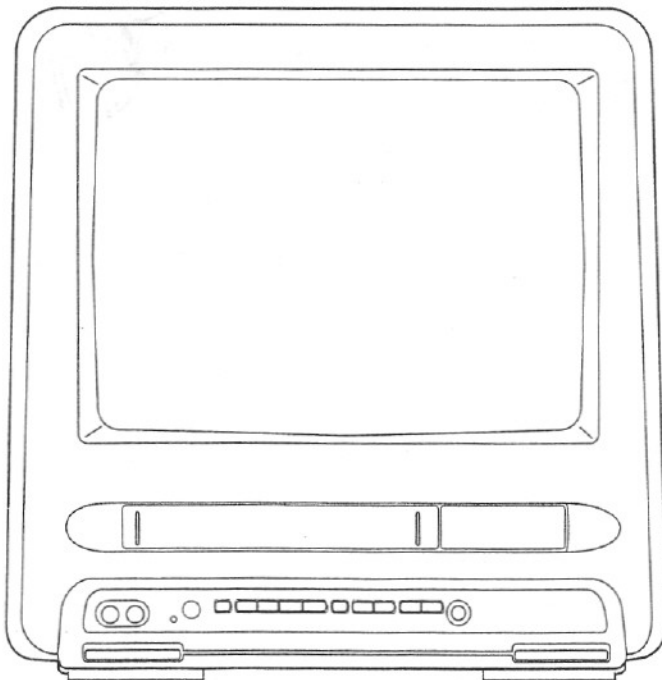

VHS

If you need additional assistance for set-up or operating
after reading owner's manual, please call
TOLL FREE : 1-800-968-3429 (Eastern time 9:00AM-4:30PM / Monday - Friday).

Please read before using this equipment

WARNING: TO REDUCE THE RISK OF FIRE OR ELECTRIC SHOCK, DO NOT EXPOSE THIS APPLIANCE TO RAIN OR MOISTURE.



CAUTION
RISK OF ELECTRIC SHOCK
DO NOT OPEN



CAUTION: TO REDUCE THE RISK OF ELECTRIC SHOCK, DO NOT REMOVE COVER (OR BACK). NO USER SERVICEABLE PARTS INSIDE. REFER SERVICING TO QUALIFIED SERVICE PERSONNEL.



THIS SYMBOL INDICATES THAT DANGEROUS VOLTAGE CONSTITUTING A RISK OF ELECTRIC SHOCK IS PRESENT WITHIN THIS UNIT.



THIS SYMBOL INDICATES THAT THERE ARE IMPORTANT OPERATING AND MAINTENANCE INSTRUCTIONS IN THE LITERATURE ACCOMPANYING THE APPLIANCE.

The caution marking is located on the rear of the cabinet.

IMPORTANT SAFEGUARDS

- 1. Read instructions**-All the safety and operating instructions should be read before the appliance is operated.
- 2. Retain Instructions**-The safety and operating instructions should be retained for future reference.
- 3. Heed Warnings**-All warnings on the appliance and in the operating instructions should be adhered to.
- 4. Follow Instructions**-All operating and use instructions should be followed.
- 5. Cleaning**-Unplug TV/VCR from the wall outlet before cleaning. Do not use liquid cleaners or aerosol cleaners. Use a damp cloth for cleaning.
EXCEPTION : A product that is meant for uninterrupted service and, that for some specific reason, such as the possibility of the loss of an authorization code for a CATV converter, is not intended to be unplugged by the user for cleaning or any other purpose, may exclude the reference to unplugging the appliance in the cleaning description otherwise required in item 5.
- 6. Attachments**-Do not use attachments not recommended by the TV/VCR manufacturer as they may cause hazards.
- 7. Water and Moisture**-Do not use this TV/VCR near water-for example, near a bath tub, wash bowl, kitchen sink, or laundry tub, in a wet basement, or near a swimming pool, and the like.
- 8. Accessories**-Do not place this TV/VCR on an unstable cart, stand, tripod, bracket, or table. The TV/VCR may fall, causing serious injury to someone, and serious damage to the appliance. Use only with a cart, stand, tripod, bracket, or table recommended by the manufacturer, or sold with the TV/VCR. Any mounting of the appliance should follow the manufacturer's instructions and should use a mounting accessory recommended by the manufacturer. An appliance and cart combination should be moved with care.

PORTABLE CART WARNING
S3125A
- 9. Ventilation**-Slots and openings in the cabinet and the back or bottom are provided for ventilation and to ensure reliable operation of the TV/VCR and to protect it from overheating. These openings must not be blocked or covered. The openings should never be blocked by placing the TV/VCR on a bed, sofa, rug, or other similar surface. This TV/VCR should never be placed near or over a radiator or heat register. This TV/VCR should not be placed in a built-in installation such as a bookcase or rack unless proper ventilation is provided or the manufacturer's instructions have been adhered to.
- 10. Power Sources**-This TV/VCR should be operated only from the type of power source indicated on the marking label. If you are not sure of the type of power supply to your home, consult your appliance dealer or local power company. For TV/VCRs intended to operate from battery power, or other sources, refer to the operating instructions.
- 11. Grounding or Polarization**-This TV/VCR is equipped with a polarized alternating-current line plug (a plug having one blade wider than the other). This plug will fit into the power outlet only one way. This is a safety feature. If you are unable to insert the plug fully into the outlet, try reversing the plug. If the plug should still fail to fit, contact your electrician to replace your obsolete outlet. Do not defeat the safety purpose of the polarized plug.
- 12. Power-Cord Protection**-Power-supply cords should be routed so that they are not likely to be walked on or pinched by items placed upon or against them, paying particular attention to cords at plugs, convenience receptacles, and the point where they exit from the appliance.

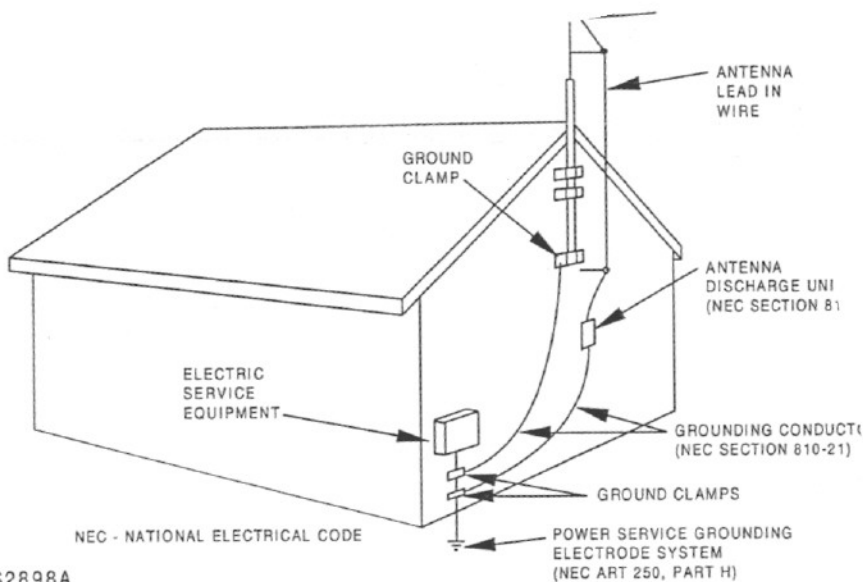

S2898A

Indoor Antenna grounding-If an outside antenna or cable system is connected to the TV/VCR, be sure the antenna or cable system is grounded so as to provide some protection against voltage surges and built-up static charges. Article 810 of the National Electrical Code, NFPA No. 70, provides information with respect to proper grounding of the mast and supporting structure, fastening of the lead-in wire to an antenna discharge unit, fastening of grounding conductors, location of antenna-discharge unit, connection to grounding electrodes, and requirements for the grounding electrode. (Fig. A)

Warning-For added protection for this TV/VCR receiver during a lightning storm, or when it is left unattended and for long periods of time, unplug it from the wall outlet and disconnect the antenna or cable system. This will prevent damage to the TV/VCR due to lightning and surges.

Precautions-An outside antenna system should not be installed in the vicinity of overhead power lines or other overhead power circuits, or where it can fall into such overhead power circuits. When installing an outside antenna system, extreme care should be taken to keep from touching overhead power lines or circuits as contact with them might

result in a risk of fire or electric shock.

Caution-Never push objects of any kind into the TV/VCR through openings as they may touch internal points or short out parts that could result in electric shock. Never spill liquid of any kind on the TV/VCR.

Warning-Do not attempt to service this TV/VCR yourself. Removing the top cover may expose you to dangerous electrical hazards. Refer all servicing to qualified service personnel.

19. Damage Requiring Service-Unplug this TV/VCR from the wall outlet and refer servicing to qualified service personnel under the following conditions:

- When the power-supply cord or plug is damaged.
- If liquid has been spilled, or objects have fallen on the TV/VCR.
- If the TV/VCR has been exposed to rain or water.
- If the TV/VCR does not operate normally by following the operating instructions. Adjust only those controls covered by the operating instructions, as improper adjustment of other controls may result in damage and may require extensive work by a qualified technician to return the TV/VCR to its normal operation.
- If the TV/VCR has been dropped or damaged in any way.
- When the TV/VCR exhibits a distinct change in picture or sound quality-this indicates a need for service.

20. Replacement Parts-When replacement parts are required, be sure the service technician has used replacement parts specified by the manufacturer that have the same characteristics as the original part. Unauthorized substitution may result in fire, electric shock, injury to persons or other hazards.

21. Safety Check-Upon completion of any service or repair to this TV/VCR, ask the service technician to perform the routine safety checks to determine that the TV/VCR is in proper operating condition.

22. Heat-This TV/VCR product should be situated away from heat sources such as radiators, heat registers, stoves, or other products (including amplifiers) that produce heat.

PRECAUTIONS

LOCATION

For safe operation and satisfactory performance of your unit, keep the following in mind when selecting a place for its installation:

- Shield it from direct sunlight and keep it away from sources of intense heat.
- Avoid dusty or humid places.
- Avoid places with insufficient ventilation for proper heat dissipation. Do not block the ventilation holes at the top and bottom of the unit. Do not place the unit on a carpet because this will block the ventilation holes.
- Install unit in a horizontal position.
- Avoid locations subject to strong vibration.
- Do not place the unit near strong magnetic fields.
- Do not move the unit from a cold to a hot place or vice versa.

AVOID THE HAZARDS OF ELECTRICAL SHOCK AND FIRE

- Do not handle the power cord with wet hands.
- Do not pull on the power cord when disconnecting it from an AC wall outlet. Grasp it by the plug.
- If, by accident, water is spilled on your unit, unplug the power cord immediately and take the unit to an authorized Funai service center for servicing.
- Do not put your fingers or objects into the TV/VCR cassette holder.
- Do not place anything directly on top of the unit.

WARNING

Moisture condensation may occur inside the unit when it is moved from a cold place to a warm place, or after heating a cold room or under conditions of high humidity. If a tape is played in a TV/VCR which has moisture, it may damage the tape and TV/VCR. Therefore when the condensation occurs inside the unit turn the POWER button on and allow at least 2 hours for the unit to dry out.

FCC WARNING- This equipment may generate or use radio frequency energy. Changes or modifications to this equipment may cause harmful interference unless the modifications are expressly approved in the instruction manual. The user could lose the authority to operate this equipment if an unauthorized change or modification is made.

IMPORTANT COPYRIGHT INFORMATION

Unauthorized recording or use of broadcast television programming, video tape, film or other copyrighted material may violate applicable copyright laws. We assume no responsibility for the unauthorized duplication, use, or other acts which infringe upon the rights of copyright owners.

This equipment has been tested and found to comply with the limits for a Class B digital device, pursuant to Part 15 of the FCC Rules. These limits are designed to provide reasonable protection against harmful interference in a residential installation. This equipment generates, uses, and can radiate radio frequency energy and, if not installed and used in accordance with the instructions, may cause harmful interference to radio communications.

However, there is no guarantee that interference will not occur in a particular installation. If this equipment does cause harmful interference to radio or television reception, which can be determined by turning the equipment off and on, the user is encouraged to try to correct the interference by one or more of the following measures:

- 1) Reorient or relocate the receiving antenna.
- 2) Increase the separation between the equipment and receiver.
- 3) Connect the equipment into an outlet on a circuit different from that to which the receiver is connected.
- 4) Consult the dealer or an experienced radio/TV technician for help.

TABLE OF CONTENTS

<ul style="list-style-type: none"> ■ IMPORTANT SAFEGUARDS..... 2 ■ PRECAUTIONS..... 4 <ul style="list-style-type: none"> LOCATION 4 AVOID THE HAZARDS OF ELECTRICAL SHOCK AND FIRE 4 WARNING 4 ■ FEATURES 6 ■ SUPPLIED ACCESSORIES 6 ■ VIDEO CASSETTE 7 ■ OPERATING CONTROLS AND FUNCTIONS.. 8 ■ PREPARATION FOR USE..... 10 <ul style="list-style-type: none"> ANTENNA/CABLE CONNECTIONS 10 INSTALLING THE BATTERIES 11 EXTERNAL INPUT MODE..... 11 USING THE SWIVEL (FOR A WHITE CABINET ONLY) 11 ■ PRESET FOR USE..... 12 <ul style="list-style-type: none"> PRESET FOR THE FIRST TIME 12 DELETING (OR ADDING) PRESET CHANNEL 12 AUTO PRESET AGAIN..... 13 SELECTING THE LANGUAGE 13 DAYLIGHT-SAVING TIME 13 SETTING THE CLOCK (AUTO / MANUAL)... 14 ■ ON SCREEN DISPLAY..... 16 ■ SPECIAL FEATURES 16 <ul style="list-style-type: none"> DEGAUSSING..... 16 AUTO REWIND-EJECT 16 	<ul style="list-style-type: none"> ■ TV OPERATION..... 17 <ul style="list-style-type: none"> WATCHING A TV PROGRAM 17 GAME MODE..... 17 PICTURE CONTROL..... 17 CLOSED CAPTION SYSTEM 18 ■ NORMAL PLAYBACK..... 19 ■ SPECIAL PLAYBACK..... 20 <ul style="list-style-type: none"> RENTAL PLAYBACK 20 REPEAT PLAYBACK..... 20 ■ SEARCH..... 21 <ul style="list-style-type: none"> COUNTER MEMORY 21 TIME SEARCH..... 21 ■ RECORDING 22 <ul style="list-style-type: none"> NORMAL RECORDING 22 SKIPPING SOME MATERIALS DURING RECORDING 22 OTR (One Touch Recording)..... 23 COPYING A VIDEO CASSETTE (Requires another VCR) 23 ■ TIMER 24 <ul style="list-style-type: none"> AUTOMATIC TIMER RECORDING 24 AUTO RETURN 26 SLEEP TIMER 26 ■ TROUBLESHOOTING GUIDE 27 ■ MAINTENANCE 28 ■ SPECIFICATIONS..... 29 ■ CABLE CHANNEL DESIGNATIONS 29 ■ WARRANTY..... 30
-----------------------------------------------------------------------------------------------------------------------------------------------------------------------------------------------------------------------------------------------------------------------------------------------------------------------------------------------------------------------------------------------------------------------------------------------------------------------------------------------------------------------------------------------------------------------------------------------------------------------------------------------------------------------------------------------------------------------------------------------------------------------------------------------------------------------------------------------------------------------------------------------------------------------------------------------------------------------------------------------------------------------------------------------------------------------------------------------------------------------------------------------------------------------------------------------------------------------------------------------------------------------------------------------------------------------------------------------------------------	---------------------------------------------------------------------------------------------------------------------------------------------------------------------------------------------------------------------------------------------------------------------------------------------------------------------------------------------------------------------------------------------------------------------------------------------------------------------------------------------------------------------------------------------------------------------------------------------------------------------------------------------------------------------------------------------------------------------------------------------------------------------------------------------------------------------------------------------------------------------------------------------------------------------------------------------------------------------------------------------------------------------------------------------------------------------------------------------------------------------------------------------------------------------------------------------------------------------------------------------------------------------------------------------------------------------------------------------------------------------------





The serial number of this product may be found on the back of the unit. No others have the same serial number as yours. You should record the number and other vital information here and retain this book as a permanent record of your purchase to aid identification in case of theft.

Date of Purchase	
Dealer Purchase from	
Dealer Address	
Dealer Phone No.	
Model No.	
Serial No.	

FEATURES

- **Infrared remote control**
- **Bilingual on screen menu display selectable in English or Spanish**
- **Real time counter**—This shows the elapsed recording or playback time in hours, minutes, and seconds. The "-" indication will appear when the tape is re-wound further than the tape counter position "0:00:00".
- **181 channel capability PLL frequency synthesizer tuner with direct station call**— (A converter may be necessary to view scrambled cable channels.)
- **Auto Clock Setting**—Allows you to use the clock function from the PBS broadcast.
- **Closed caption system**— You may view specially labeled (cc) TV programs, movies, news, prerecorded tapes, etc. with either a dialogue caption or text display added to the program.
- **Game mode**— Allows TV/VCR display to be suitable for use with a TV game.
- **Auto power on system**— (when inserted a tape)
- **Auto rewind-eject when the end of a tape is reached**—(not in the case of timer recording).
- **2 Step picture search operation**— You can view a video program at a high speed or super high speed in either a forward or reverse direction in LP and SLP mode.
- **Still**—"Freeze" the picture at any time, for close viewing of a particular scene. Only tapes recorded in SLP mode will show a fairly clear picture.
- **Digital Auto Tracking (DTR)**—Adjusts the tracking automatically for each tape you play.
- **Rental play mode**— Improves playback picture quality of worn tapes, especially rental tapes.
- **Auto repeat**—Allows you to repeat a tape indefinitely without pressing the PLAY button.
- **Time search**— Allows you to set the TV/VCR to advance the tape by entering the desired playback time you want to skip.
- **Three different tape speeds : SP/LP/SLP**
- **OTR (One Touch Recording)**—Instant timed recording from 30 to 480 minutes is possible at the push of the REC/OTR button.
- **1 Year, 8 events (including Daily and Weekly Timer Recording)**—The built-in timer allows you to record up to 8 programs at different times on different channels up to 1 year in advance. The Daily timer allows recordings to be made of daily broadcasts, and the Weekly timer allows recording to be made once a week up to the end of the tape.
- **Auto return**—After finished timer recording, the beginning of the recorded program(s) can be searched.
- **Sleep timer**—Allows you to turn off the TV/VCR without using the POWER button after a desired time period.

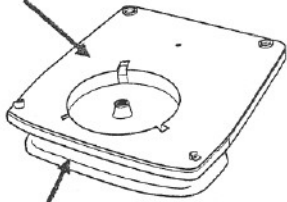
SUPPLIED ACCESSORIES

<p>Remote Control Unit</p> 	<p>Rod Antenna</p>  <p>PART NO. (0EMN00673)</p>	<p>For a white cabinet only Swivel (Upper Piece), PART NO. (0EM100778)</p>  <p>Swivel (Foundation) PART NO. (0EM100779)</p>
<p>PART NO. (For a black cabinet ... N0200UD) (For a white cabinet ... N0208UD)</p>	<p>2 AA Batteries</p> 	<p>For a white cabinet only</p>  <p>3 Screws, PART NO. (46-57569-3)</p>

- If you need to replace these accessories, please refer to the PART NO. under the illustrations and contact the FUNAI parts department for ordering.

VIDEO CASSETTE

This TV/VCR will operate with any cassette that has the VHS mark. For best results, we recommend the use of high-quality tapes. *Do not use poor quality or damaged tapes.*

PRECAUTIONS

- Avoid moisture. Moisture condensation may occur on the tape if it is moved from a cold place to a warm place. Before using a tape with these conditions, to avoid a damage of the tape and your TV/VCR, wait until the tape has warmed to room temperature and the moisture has evaporated.
- Avoid extreme heat, high humidity and magnetic fields.
- Do not tamper with the cassette mechanism.
- Do not touch the tape with your fingers.

THREE DIFFERENT TAPE SPEEDS

Before recording, select the tape speed from : **SP mode** (Standard Play), **LP mode** (Long Play) or **SLP mode** (Super Long Play).

The table below shows the maximum recording/playback time using T60, T120 or T160 tapes in each mode.

Tape Speed	Recording/Playback Time			
	Type of tape	T60	T120	T160
SP mode		1 hour	2 hours	2-2/3 hours
LP mode		2 hours	4 hours	5-1/3 hours
SLP mode		3 hours	6 hours	8 hours

INSERTING A CASSETTE

Insert the cassette in the direction as shown. Push in gently, but continuously, on the center-back of the cassette until it is drawn into the TV/VCR.

The TV/VCR will automatically turn on.

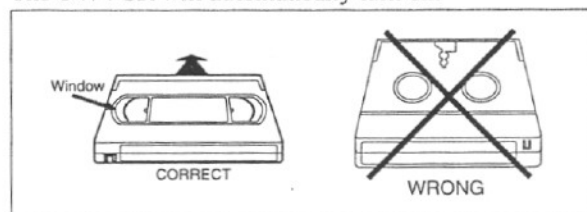

REMOVING A CASSETTE

- 1) In the Stop mode, press EJECT button on the remote control or press STOP/EJECT button on the TV/VCR. The cassette will eject.
- 2) Pull the cassette out of the cassette compartment.
- 3) Store the cassette in its case as shown.

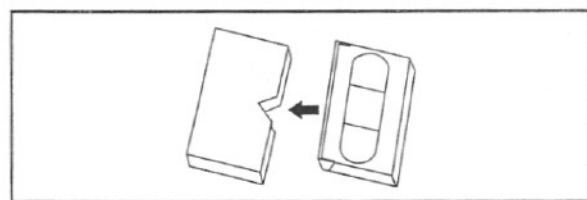

ERASE PREVENTION

You can prevent accidental erasing of recording by breaking off the tab on the back edge of the cassette.

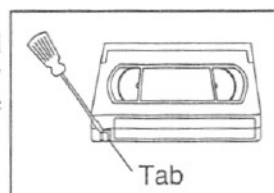

If you decide to record on the tape again, cover the hole with a plastic tape

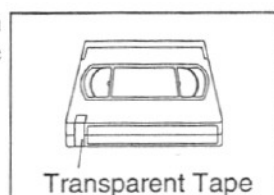

OPERATING CONTROLS AND FUNCTIONS

- FRONT VIEW -

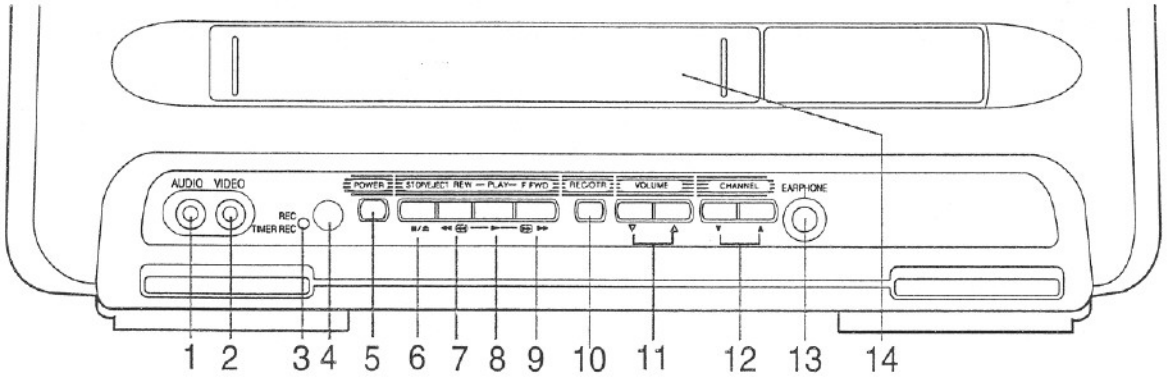

- REMOTE CONTROL VIEW -

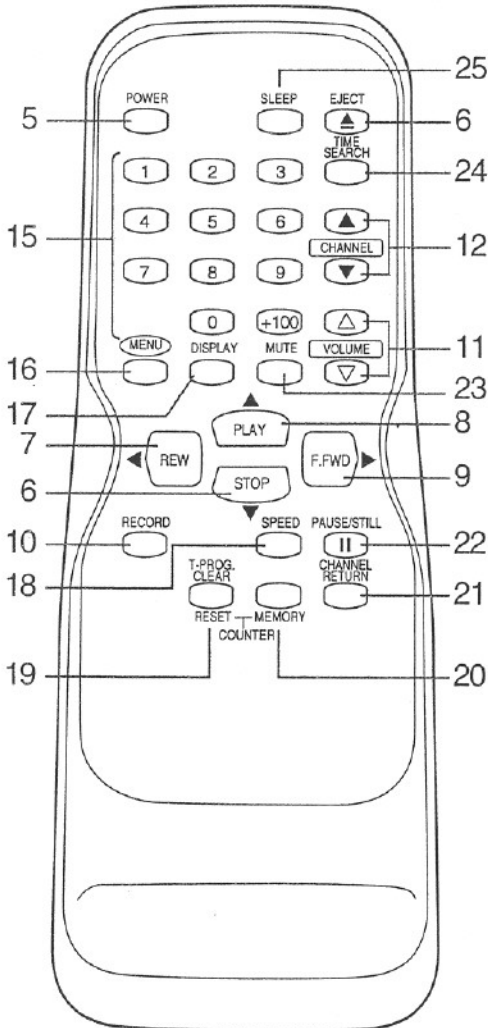

- 1 **AUDIO input jack**– Connect to audio output jack of your audio equipment or another VCR.
- 2 **VIDEO input jack**– Connect to video output jack of your video camera or another VCR.
- 3 **REC indicator**– Flashes during recording.
TIMER REC indicator– Lights up in the Stand-by mode for Timer Recording.
- 4 **Remote Sensor**– Receives the infrared control signals from the handheld remote control unit.
- 5 **POWER button**– Press to turn TV/VCR on and off. Press to activate the automatic timer recording.
- 6 **STOP button** –Press to stop the tape motion.
EJECT button– Press in the Stop mode to remove a tape from the TV/VCR.
- 7 **REW button**– Press to rewind the tape, or to view the picture rapidly in reverse during the Play mode. (Rewind Search)
▲ button– Press to select a mode from a particular menu (for example: LANGUAGE or USER'S SET UP)
- 8 **PLAY button**– Press to begin playback of a tape.
▲ button– Press to select setting modes from on screen menu.
● Press to enter digits when setting program (for example: setting clock or timer program).
- 9 **▼ button**– Press to select setting modes from on screen menu.
● Press to enter digits when setting program (for example: setting clock or timer program).
- 10 **RECORD**
- 11 **VOLUME**
- 12 **CHANNEL**
- 13 **0**
- 14 **1**
- 15 **2**
- 16 **3**
- 17 **4**
- 18 **5**
- 19 **T-PROG CLEAR**
- 20 **RESET MEMORY COUNTER**
- 21 **CHANNEL RETURN**
- 22 **PAUSE/STILL**
- 23 **SPEED**
- 24 **TIME SEARCH**
- 25 **SLEEP**

- REAR VIEW -

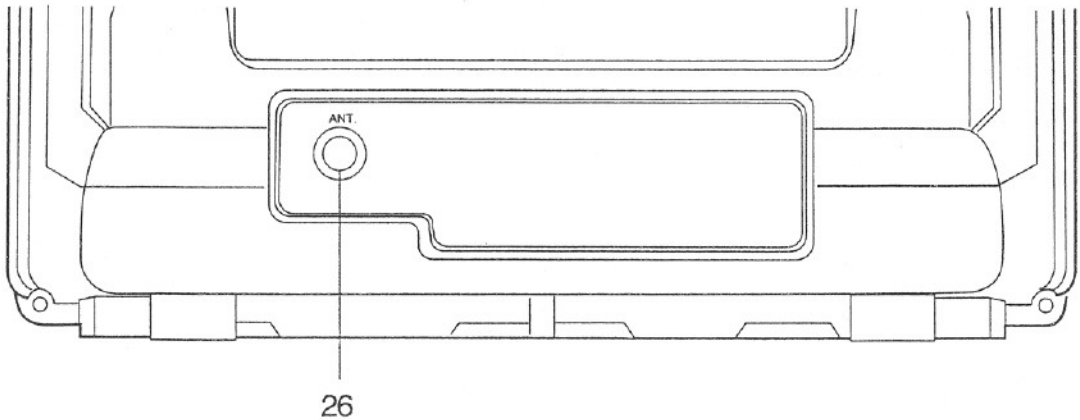

- 9 F.FWD button**— Press to rapidly advance the tape, or to view the picture rapidly in forward during the Play mode. (Forward Search)
- ▶ button**—
- When setting program (for example: setting clock or timer program), press to determine your selection and proceed to a next step you want to input.
 - Press to determine setting modes from on screen menu.
 - Press to select a mode from a particular menu (for example: LANGUAGE or USER'S SET UP)
- 10 REC button**— Press to begin manual recording.
- OTR button**— Press to activate One Touch Recording. (used on the TV/VCR only)
- 11 VOLUME ▲/▼ buttons**— Press to adjust the volume level.
- 12 CHANNEL ▲/▼ buttons**— Press to select the channel for viewing or recording.
- TRACKING +/- function**— Press to minimize video 'noise' (lines or dots on screen) during the Play mode. (See page 19.)
- 13 EARPHONE jack**— Connect to earphone (not supplied) for personal listening. The size of jack is 1/8" monaural (3.5mm).
- 14 Cassette compartment**
- 15 Number buttons**— Press to select desired channels for viewing or recording. To select channels 1 to 9, first press the 0 button and then 1 to 9.
- +100 button**— Press to select cable channels which are equal or greater than number 100. (To select channel 125, first press "+100" button then press "2" and "5").
- 16 MENU button**— Press to display main menu on the TV screen.
- 17 DISPLAY button**— Press to display the counter or the current channel number and current time on the TV screen. (See page 16)
- 18 SPEED button**— Press to set desired recording speed. (SP/LP/SLP)
- 19 T-PROG. CLEAR button**— Press to cancel a programming of timer recoding (See page 25).
- COUNTER RESET button**— Press to reset counter to 0:00:00.
- 20 COUNTER MEMORY button**— Press to set counter memory on and off. (See page 21.)
- 21 CHANNEL RETURN button**— Press to go back to the previously viewed channel. For example, pressing this button once will change channel display from 3 (present channel) to 10 (previously viewed channel), and pressing it a second time will return from 10 to 3.
- 22 PAUSE/STILL button**— Press to temporarily stop the tape during the recording or to view a still picture during playback.
- 23 MUTE button**— Press to mute sound. Press it again to resume sound.
- 24 TIME SEARCH button**— Press to activate Time Search mode.
- 25 SLEEP button**— Press to set the Sleep Timer. (See page 26.)
- 26 ANT. terminal**— Connect to an antenna or CATV.

PREPARATION FOR USE

ANTENNA/CABLE CONNECTIONS

VHF/UHF COMBINED ANTENNA

The VHF/UHF Rod Antenna (supplied) is detachable. Push the stem of the antenna into the hole which is located on the upper back cabinet of the unit.

Connect the VHF/UHF Rod Antenna or VHF/UHF Combination Antenna to the ANT. terminal of the TV/VCR as shown in the diagram below.

For the best reception, extend the VHF/UHF Rod Antenna fully and adjust its position. (Avoid handling the top section when making adjustments.)

NOTE :

Before plugging the Rod antenna into antenna terminal, check that the pin is not bent. If it is bent, straighten the pin as illustrated, then plug the pin into antenna terminal.

VHF/UHF SEPARATE ANTENNAS

In some areas it will be necessary to use an outdoor antenna.

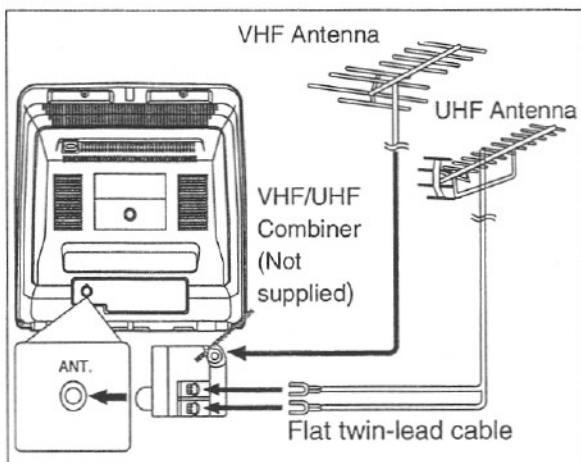

CABLE WITHOUT CONVERTER/DESCRAMBLER BOX

Use this connection if your cable system connects directly to your TV/VCR without a converter box.

With this connection you, 1) can use your TV/VCR Remote Control to select channels, 2) program one or more unscrambled channels for Automatic Timer Recording.

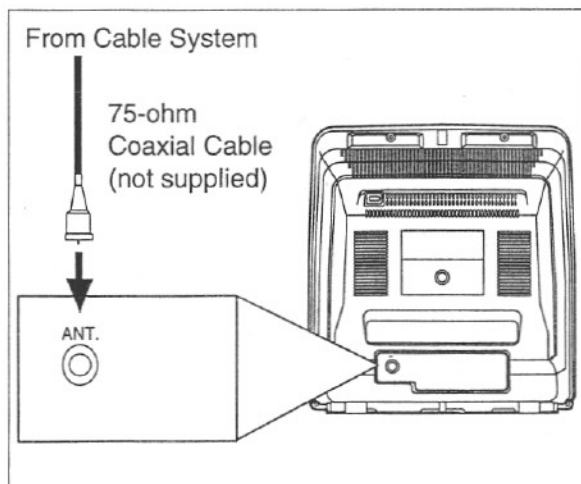
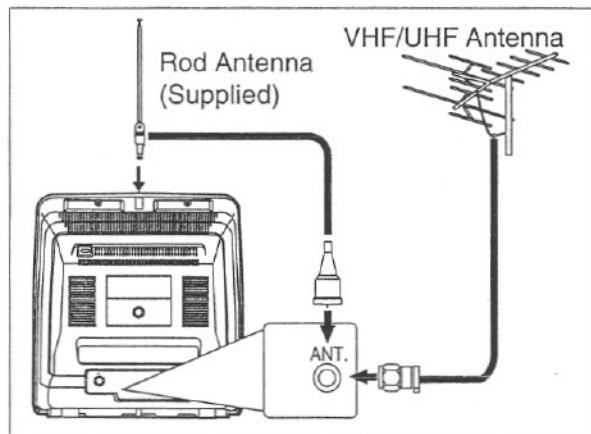
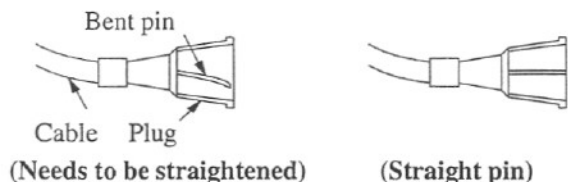

Note to CATV system installer:

This reminder is provided to call the CATV system installer's attention to Article 820-40 of the NEC that provides guidelines for proper grounding and, in particular, specifies that the cable ground shall be connected to the grounding system of the building as close to the point of cable entry as practical.

CABLE WITH CONVERTER/DESCRAMBLER BOX OR SATELLITE BOX

If your cable service supplies you with a converter box or if you use a satellite system, you can use the basic connection shown here.

With this connection you can record and view any channel including scrambled channels. However, channel selection must be made with the converter box. This means that channels cannot be changed using the TV/VCR Remote Control. Unattended recording is limited to one channel at a time.

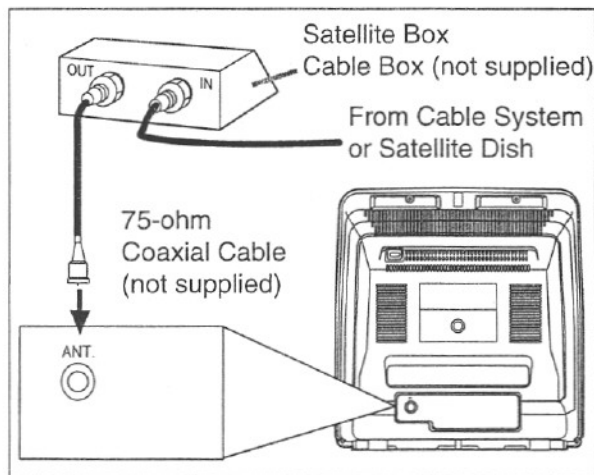

TO RECORD AND VIEW A SCRAMBLED/UNSCRAMBLED CHANNEL

1. Set the TV/VCR channel selector to the output channel of the cable converter box or satellite box. (Ex. CH3)
2. Select the channel to be recorded or viewed on the cable converter box or satellite box.

INSTALLING THE BATTERIES

- 1) Open the battery compartment cover by pressing the cover on the remote unit in the direction of the arrow.
- 2) Insert 2 "AA" penlight batteries into the battery compartment in the direction indicated by the polarity (+/-) markings.
- 3) Replace the cover.

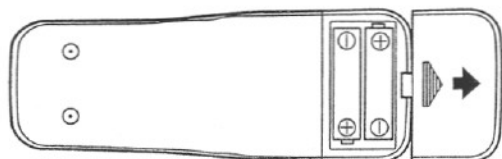

EXTERNAL INPUT MODE

When using an external input signal (another VCR or camcorder), connect the player's audio/video output cables to the AUDIO IN, VIDEO IN jacks of your TV/VCR. Then press CHANNEL▲ or ▼ button or enter "00" with number button so that "AUX" appears on the screen.

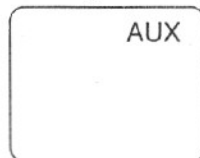

USING THE SWIVEL (FOR A WHITE CABINET ONLY)

CAUTION: Always place the swivel on a flat surface.

- 1) Carefully place the TV/VCR upside down and attach the assembled swivel to the bottom of the TV/VCR as shown.

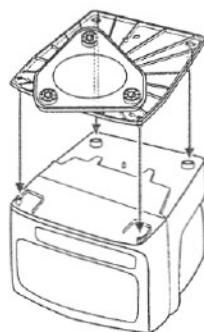

- 2) Put the screw (supplied) into the holes marked by the arrow.

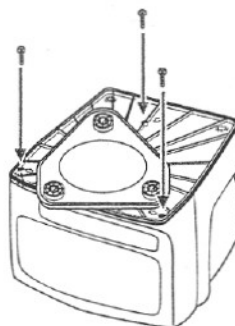

- 3) Place the TV/VCR right-side up. You now can rotate the TV/VCR in either direction.

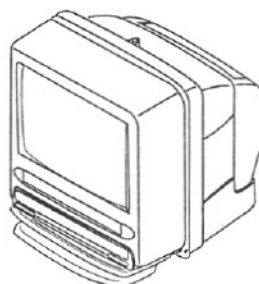

PRESET FOR USE

For the first time you may want to select language (English or Español=Spanish) and preset the tuner to scan only the channels you receive in your area. **You must use the remote control for the following steps.**

NOTE: Channel memory programming is not needed when using a converter/descrambler box. Just select the TV/VCR channel selector to the output channel of the cable box or satellite box (Ex CH3). Then select the channel to be viewed on the cable box or satellite box.

PRESET FOR THE FIRST TIME

1 Plug the TV/VCR power cord

Plug the TV/VCR power cord into a standard AC outlet.

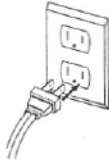

2 Turn on the TV/VCR

Press POWER button to turn on the TV/VCR.

3 Select "ENGLISH" or "ESPAÑOL"

Select "ENGLISH" or "ESPAÑOL=Spanish" using F.FWD/▶ or REW/◀ button. "[]" marks indicate the selected language.

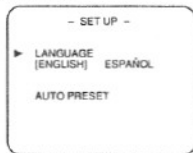

4 Begin auto preset

Press PLAY/▲ or STOP/▼ button to point to "AUTO PRESET".

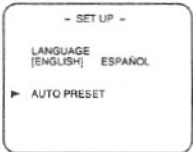

Then press F.FWD/▶ button. The tuner scans and memorizes all the active channels in your area.

NOTES:

- The TV/VCR distinguishes between standard TV channels and CATV automatically.
- If you want to play or record a video tape BEFORE presetting the tuner, you must press MENU button. To preset the tuner again, see "AUTO PRESET AGAIN".

5 After scanning

The tuner stops on the lowest memorized channel. (TV mode: from CH 02/ CATV mode: from CH 01)

If you want to recall the selected channels, you can select the desired channel directly with the remote control number button or CH ▲ or ▼.

TO RETURN TO TV MODE WHEN SCANNING

Press MENU button in scanning mode.

DELETING (OR ADDING) PRESET CHANNEL

The channels you no longer receive or seldom watch can be deleted from the memory. (Of course, you can add the deleted channel into the memory again.)

1 Select "CHANNEL SET UP"

Press MENU button.

Press PLAY/▲ or STOP/▼ button repeatedly to point to "CHANNEL SET UP".

Then, press F.FWD/▶ button.

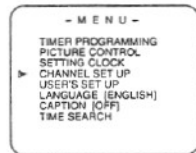

2 Select "ADD/DELETE CH"

Press PLAY/▲ or STOP/▼ button repeatedly to point to "ADD/DELETE CH".

Press F.FWD/▶ button.

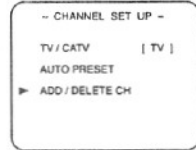

3 Enter the desired channel number

Press PLAY/▲ or STOP/▼ button repeatedly until your desired channel number appears. (You can also use the number buttons or the CH ▲/▼ button to enter it) (Example: CH8)

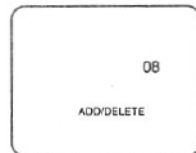

4 Delete (or add) it from (into) memory

Press F.FWD/▶ or REW/◀ button. The channel number changes to light red. The channel is deleted from memory.

- To delete another channel, repeat steps [3] and [4].
- If you press F.FWD/▶ or REW/◀ button again, the channel is memorized again.

**Added channel is in light blue.
Deleted channel is in light red.**

5 Exit the channel setup mode

Press MENU button to returns to TV mode.

NOTE: To confirm that channel(s) has been deleted or added, press CH ▲ or ▼ button.

AUTO PRESET AGAIN

1 Select "CHANNEL SET UP"

Press MENU button.

Press PLAY/▲ or STOP/▼ button repeatedly to point to "CHANNEL SET UP".

Then, press F.FWD/▶ button.

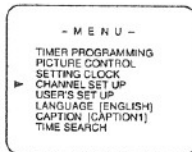

2 Select "TV" or "CATV"

Select [TV] or [CATV] using F.FWD/▶ or REW/◀ button.

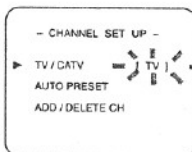

3 Begin auto preset

Press PLAY/▲ or STOP/▼ button to point to "AUTO PRESET".

Then, press F.FWD/▶ button. The tuner scans and memorizes all the active channels in your area.

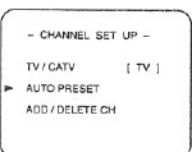

4 After scanning

The tuner stops on the lowest memorized channel. (TV mode: from CH02 / CATV mode: from CH01)

SELECTING THE LANGUAGE

1 Select "LANGUAGE"

Press MENU button.

Press PLAY/▲ or STOP/▼ button repeatedly to point to "LANGUAGE".

2 Select "ENGLISH" or "ESPAÑOL"

Select "ENGLISH" or "ESPAÑOL= Spanish" using F.FWD/▶ or REW/◀ button.

3 Exit the Language mode

Press MENU button to return to the TV mode.

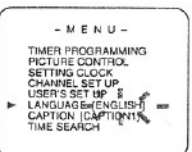

DAYLIGHT-SAVING TIME

Select this feature and the TV/VCR's clock automatically will advance one hour in April, then reverse one hour in October.

When Daylight-Saving Time is ON, the clock will change automatically as follows:

- **First Sunday of April : from 2:00AM to 3:00AM (summer time):** When programmed recording starts between 2:00AM - 2:59AM on this day, the TV/VCR will start recording at 3:00AM.
- **Last Sunday of October : From 1:00AM to 2:00AM** When programmed recording ends between 1:00AM - 1:59AM on this day, the TV/VCR will stop at 2:00AM.

Make sure ...

- Press POWER button to turn on the TV/VCR.
- You must use the remote control for the following steps.

1 Select "SETTING CLOCK"

Press MENU button.

Press PLAY/▲ or STOP/▼ button repeatedly to point to "SETTING CLOCK".

Then, press F.FWD/▶ button.

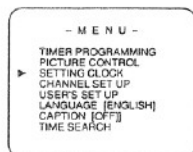

2 Set "D.S.T." (Daylight-Saving Time) to [ON]

Press PLAY/▲ or STOP/▼ button repeatedly to point to "D.S.T".

3 Set "D.S.T." (Daylight-Saving Time) to [ON]

Press F.FWD/▶ or REW/◀ button repeatedly until [ON] appears.

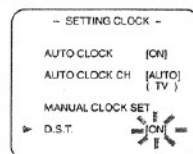

4 Exit the Daylight-Saving Time mode

Press MENU button to return to the TV mode.

TO CANCEL THE DAYLIGHT-SAVING TIME

Repeat steps [1] to [3]. Then, press F.FWD/▶ or REW/◀ button until [OFF] appears and press MENU button to return to TV mode.

SETTING THE CLOCK (AUTO / MANUAL)

Set the clock accurately for proper automatic timer recording. If the Public Broadcasting Station (PBS) is available in your area, follow "AUTO CLOCK SETTING". If it is not, follow "MANUAL CLOCK SETTING".

AUTO CLOCK SETTING

You can have the TV/VCR set the clock automatically by using the Public Broadcasting Station (PBS) channel in your area. Once you have set the clock by using the following procedure, the TV/VCR will automatically monitor the correct time and date being broadcast by the PBS station in your area, using a new service called Extended Data Service (XDS).

Make sure ...

- Press POWER button to turn on the TV/VCR set.
- Confirm that the antenna connections are correct.
- The cable converter box must be turned on if your TV/VCR is connected directly to it. (See NOTES:)
- You must use the remote control for the following steps.
- The channel you want to record is properly set in advance. (See page 13)

NOTES:

- Auto clock setting only has to be done one time. You may set the clock only if the clock's time has become incorrect for some reason.
- If the TV/VCR is connected directly to a cable converter box, the local PBS station must be selected on the cable box itself, and the TV/VCR must be set to the output channel of the cable converter box (usually channel 3 or 4), to be able to set up or correct the clock automatically.
The TV/VCR cannot control the channels of the cable converter box.
- If there is no local PBS station in your area or on your cable system, proceed to MANUAL CLOCK SETTING on page 15.

1 Select "SETTING CLOCK"

Press MENU button.

Press PLAY/▲ or STOP/▼ button repeatedly to point to "SETTING CLOCK".

Then, press F.FWD/▶ button.

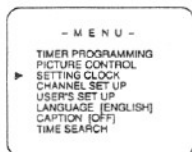

2 Set "AUTO CLOCK" to [ON]

Press F.FWD/▶ or REW/◀ button repeatedly until [ON] appears.

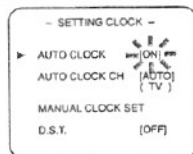

3 Enter the channel number for the PBS station

Press PLAY/▲ or STOP/▼ button repeatedly to point to "AUTO CLOCK CH".

Then press F.FWD/▶ or REW/◀ button repeatedly until the channel number for your local PBS station appears.

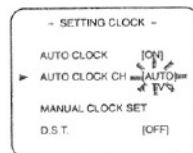

If you do not know the PBS channel number, remain on [AUTO]. The TV/VCR will automatically search all available channels for the local PBS station, and will select that channel.

4 Exit the Auto Clock Setting

Press MENU button to return to the TV mode.

5 Turn off the TV/VCR

Press POWER button to turn off the TV/VCR for searching the local PBS station. **The power must remain off during this search.**

If you enter the channel number manually,

- It may take a few minutes for this search to be completed.

If you choose [AUTO],

- The TV/VCR must search through all the available channels one by one, starting with the lowest numbered channel. It must scan each channel for a couple of seconds to determine if that channel is transmitting the XDS signal. This search could take up to 10 minutes if the local PBS station is on a high numbered channel in your area or on your cable system.

If the time that is automatically set by this selected PBS station is incorrect, it may not be your local PBS station, but one from a different time zone. Or there is a possibility that no channel in your area is broadcasting the XDS signal, as evidenced by no time being set even after 10 minutes search. In these cases, you must manually enter the correct local PBS station, or set the clock manually and turn off the Auto Clock Setting feature.

MANUAL CLOCK SETTING

Make sure ...

- You must use the remote control for the following steps.
- Power must be turned on.

1 Select "SETTING CLOCK"

Press MENU button.

Press PLAY/▲ or STOP/▼ button repeatedly to point to "SETTING CLOCK".

Then, press F.FWD/▶ button.

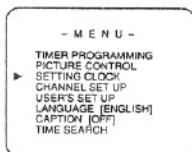

2 Select "MANUAL CLOCK SET"

Press PLAY/▲ or STOP/▼ button repeatedly to point to "MANUAL CLOCK SET".

Then, press F.FWD/▶ button.

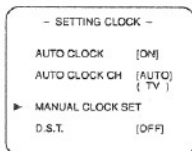

3 Select the month

Press PLAY/▲ or STOP/▼ button repeatedly until your desired month appears. (Example: "03" for March)

Then, press F.FWD/▶ button.

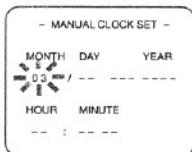

4 Select the day

Press PLAY/▲ or STOP/▼ button repeatedly until your desired day appears. (Example: "01" for 1st)

Then, press F.FWD/▶ button.

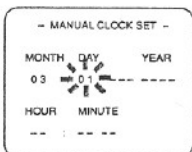

5 Select the year

Press PLAY/▲ or STOP/▼ button repeatedly until your desired year appears. (Example: 1997)

Then, press F.FWD/▶ button.

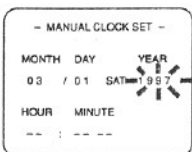

In the example below, the clock is to be set to:

DATE March 1st, 1997

SETTING TIME 5:40PM

6 Select the hour

Press PLAY/▲ or STOP/▼ button repeatedly until your desired hour appears. (Example: 5, PM)

Then, press F.FWD/▶ button.

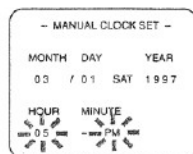

7 Select the minute

Press PLAY/▲ or STOP/▼ button repeatedly until the desired minute appears. (Example: 40)

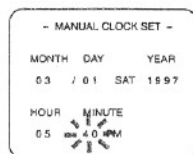

8 Start the clock

Press MENU button.

Although seconds are not displayed, they begin counting from 00 when you press MENU button. Use this feature to synchronize the clock with the correct time.

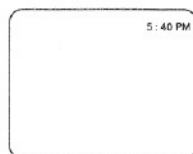

- This unit has a built in calendar up to the year 2010.

TO CHANGE CLOCK SETTING

If you want to change the clock,

- 1) Follow steps [1] and [3].
- 2) Select a digit you want to change using F.FWD/▶ or REW/◀ button.
- 3) Enter correct numbers using PLAY/▲ or STOP/▼ button.
- 4) Press MENU button to start the clock.

ON SCREEN DISPLAY

To check the Counter, Clock and Channel number on the TV screen, press DISPLAY button on the remote control. Each time you press DISPLAY button on the remote control, the TV screen will change as follows:

When the Closed Caption mode is OFF:

- In the Counter mode, after 5 seconds, only the counter remains. To clear it, press DISPLAY button.
- In the Clock mode, after 5 seconds, only the clock and the channel number remain. To clear them, press DISPLAY button.

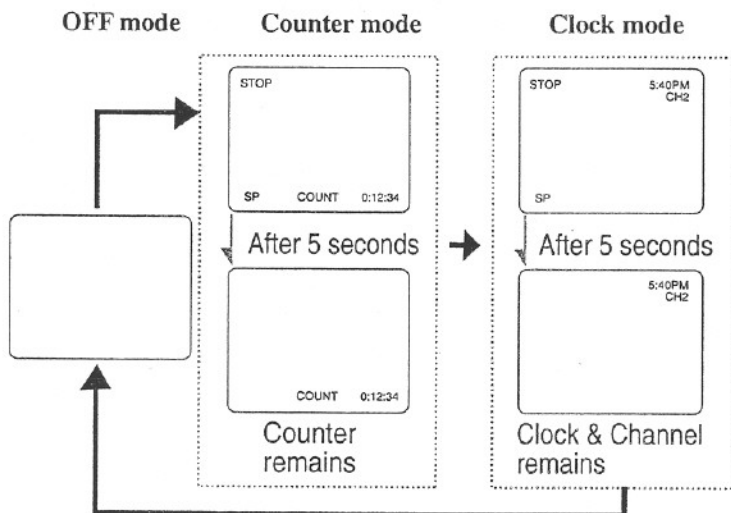

When the Closed Caption mode is ON:

- The On Screen Display will disappear after 5 seconds.
- This is true even if MUTE button is pressed, or PAUSE/STILL button is pressed while recording. However, the On Screen Display will appear for 5 seconds when DISPLAY button is pressed.

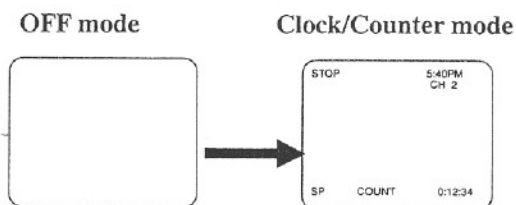

SPECIAL FEATURES

DEGAUSSING

Magnetism from nearby appliances might affect the color of the TV picture.

If this happens, move this unit away from the appliance. If the color is still not correct, disconnect power cord from AC outlet then reconnect it after 30 minutes.

AUTO REWIND-EJECT

- When the end of a tape is reached during recording, playback, or fast-forward, the tape will automatically rewind to the beginning, power off and tape ejects.
- This function is operative when Repeat Play is set to the [OFF] position.
- The tape will not auto-rewind during timer recording or One Touch Recording.
- When the tape is rewound to the preset memory position of the Counter Memory during Auto Rewind, the tape will not eject and TV/VCR will not turn off.

TV OPERATION

WATCHING A TV PROGRAM

1 Turn on the TV/VCR

Press POWER button to turn on the TV/VCR.

2 Select the channel number

Press CH ▲ or ▼ button to select your desired channel number.

3 Adjust the volume as you need

Press VOLUME ▲ or ▼ button to adjust the volume.



GAME MODE

This function enables you to decrease the TV screen contrast making it suitable for use with a TV GAME.

Make sure ...

- You must use the remote control for the following steps.

1 Select "USER'S SET UP"

Press MENU button.

Press PLAY/▲ or STOP/▼ button repeatedly to point to "USER'S SET UP".

Then, press F.FWD/▶ button.

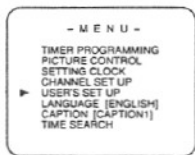

2 Set "GAME MODE" to [ON]

Confirm "GAME MODE" is pointed.

Press F.FWD/▶ or REW/◀ button repeatedly until [ON] appears.

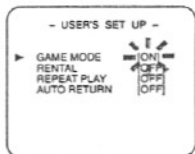

3 Exit the Game mode

Press MENU button to return to the TV mode.

TO CANCEL THE GAME MODE

Repeat step [1]. Then, step [2] to select [OFF]. Press MENU button to return to TV mode.

PICTURE CONTROL

The TV/VCR's picture controls – BRIGHT, CONTRAST, COLOR, TINT and SHARPNESS – are pre-set to the factory specification. This is usually best, but if you need to make any further adjustments, adjust picture controls for a natural looking image.

NOTES:

- Procedures must be followed within 5 seconds. Otherwise the Picture Control mode will be cancelled.
- When setting the Picture Control, the Game mode will be automatically set to [OFF].

Make sure ...

- You must use the remote control for the following steps.

1 Select "PICTURE CONTROL"

Press MENU button.

Press PLAY/▲ or STOP/▼ button repeatedly to point to "PICTURE CONTROL".

Then, press F.FWD/▶ button.

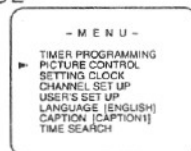

2 Select item you want to adjust

Press PLAY/▲ or STOP/▼ button repeatedly until desired control is displayed.

Each time you press PLAY/▲ or STOP/▼ button, "BRIGHT", "CONTRAST", "COLOR", "TINT" and "SHARPNESS" will appear on the TV screen in sequence.



3 Adjust the picture control

Press F.FWD/▶ or REW/◀ button to adjust the picture control to your desired level.

	REW/◀	F.FWD/▶
BRIGHT	to decrease brightness	to increase brightness
CONTRAST	to decrease contrast	to increase contrast
COLOR	to pale	to brilliant
TINT	to purple	to green
SHARPNESS	to soft	to clear

CLOSED CAPTION SYSTEM

You may view specially labeled (cc) TV programs, movies, news, prerecorded tapes, etc. with either a dialogue caption or text display added to the program.

CAPTION mode: You may watch dramas, movies and news etc. while captioning the dialogues and the contents of news if you want by choosing the caption mode.

TEXT mode: You may watch screen text information if you want by choosing the text mode.

1/2: You may get these captions or text information by selecting either "1" or "2". "2", when used, will usually be for a second language.

NOTE:

Not all programs are broadcast with closed captions. Your television is designed to provide error free closed captions from high quality antenna, cable and VCR signals. Conversely, poor quality signals are likely to result in caption errors or no captions at all. Common signal conditions which may cause captions errors are listed below;

- Automobile ignition noise.
- Electric motor brush noise.
- Weak snowy picture.
- Multiplex signal reception displaying picture ghosts or airplane flutter.
- Playback of poorly recorded or worn VCR tapes.
- If the TV/VCR displays a black box on the TV screen, this means that the TV/VCR is set to the TEXT mode. To clear screen, select [CAPTION1], [CAPTION2] or [OFF].

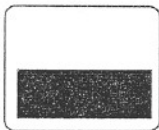

Make sure ...

- You must use the remote control for the following steps.
- Power must be turned on.

1 Select "CAPTION"

Press MENU button.

Press PLAY/▲ or STOP/▼ button repeatedly to point to "CAPTION".

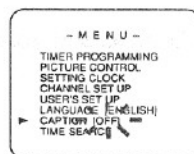

2 Select your desired caption menu

Press F.FWD/▶ or REW/◀ button repeatedly until your desired caption menu appears.

([CAPTION1], [CAPTION2], [TEXT1] or [TEXT2])

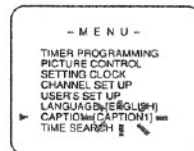

3 Exit the caption setting mode

Press MENU button to return to the TV mode.

TO CANCEL THE CLOSED CAPTION SYSTEM

Repeat steps [1] and [2], select [OFF] using F.FWD/▶ or REW/◀ button.

WHEN THE CLOSED CAPTION MODE IS ON

The On Screen Display will disappear after 5 seconds.

- This is true even if MUTE button is pressed, or PAUSE/STILL button is pressed while recording. However, On Screen Display will appear for 5 seconds when DISPLAY button is pressed.

NORMAL PLAYBACK

Make sure ...

- Power must be turned on.

1 Insert a prerecorded tape

If the erase-protection tab has been removed, the TV/VCR will start playback automatically.

2 To begin playback

Press PLAY button.

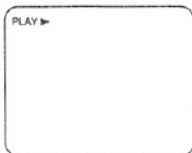

3 To stop playback

Press STOP button when playback is completed.



TRACKING ADJUSTMENT

- Tracking adjustment will be set automatically (Digital Tracking function) when you start playback.
- When playing pre-recorded tapes or tapes recorded on units other than your own, noise lines (black and white streaks) may appear on the playback picture. If this occurs, adjust the tracking control by pressing CH ▲ or ▼ button until the streaks disappear. To return to the DTR function, stop the tape once and start playback again.

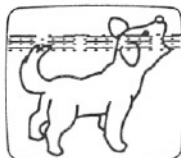

PICTURE SEARCH

This feature is useful in finding or skipping over a particular scene on a tape. In this mode, the sound will be muted.

- 1) You may view a video tape at a high speed in either a forward or reverse direction by pressing F.FWD or REW button. (in the SP / LP / SLP modes)
- 2) Depress it again, the TV/VCR will now search in super high speed. (in the LP / SLP modes)
NOTE: Tapes recorded in the SP or LP mode will display a noise bar on the TV screen and the picture may revert to Black and White. This is normal.
- 3) For normal speed, simply press PLAY button.

STILL PICTURE

You can view a still picture on the screen during playback (the Still mode). Press PAUSE/STILL button during playback. Only tapes recorded in the SLP mode will show the least amount of lines.

Press PLAY button to return to playback.

NOTES:

- Usually there will be video "noise" lines (black and white streaks or dots) on the screen. This is normal. If the tape was originally recorded in SP or LP mode, the still picture will, in addition to the "noise" lines, be black and white. This is not a fault of the machine but merely a by-product of the technology involved in producing a TV/VCR with LP mode.
- If it is left in the Pause mode for more than five minutes, the TV/VCR will automatically switch to the Stop mode.

NOISE CANCEL (in the Still mode)

This feature allows you to reposition or reduce the noise lines of a still picture.

Press PAUSE/STILL button repeatedly so that the noise lines change position on the screen and you can see the picture in its entirety without distracting noise lines.

NOTE: This feature can be activated ONLY when you use a tape recorded in the SLP mode. If the tape was originally recorded in the SP or LP mode, the still picture may, in addition to the "noise bars", revert to black and white. This is normal.

Make sure ...

- You must use the remote control for the following steps.
- Power must be turned on.
- Insert a prerecorded tape.
- Before playback, follow steps below.

RENTAL PLAYBACK

This function enables you to improve the picture quality when playing back worn cassettes such as those rented from a video shop.

1 Select "USER'S SET UP"

Press MENU button.

Press PLAY/▲ or STOP/▼ button repeatedly to point to "USER'S SET UP".

Then, press F.FWD/▶ button.

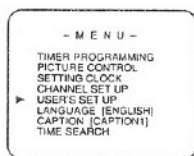

2 Set "RENTAL" to [ON]

Press PLAY/▲ or STOP/▼ button to point to "RENTAL".

Press F.FWD/▶ or REW/◀ button repeatedly until [ON] appears.

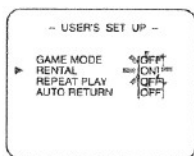

3 Exit the Rental setting

Press MENU button to return to the TV mode.

4 Start playback

Press PLAY button to start playback. "RENTAL PLAY▶" appears.

- Once you select the Rental mode, it stays in effect even after you turn off the TV/VCR.

TO CANCEL THE RENTAL MODE

Repeat steps [1]. Then, follow step [2] but select [OFF]. Press MENU button to return to TV mode.

REPEAT PLAYBACK

The TV/VCR has an auto repeat function that allows you to repeat a tape indefinitely without using the PLAY button. There are two selections for Auto Repeat Playback.

ALL REPEAT: repeat playback from the beginning to the end of the tape.

BLANK REPEAT: repeat playback from the beginning to the blank part, which is not recorded anything for more than 10 seconds.

NOTE: All buttons except POWER and STOP buttons do not work during Repeat Playback. Always set the Repeat Playback to [OFF] when not in use.

1 Select "USER'S SET UP"

Press MENU button.

Press PLAY/▲ or STOP/▼ button repeatedly to point to "USER'S SET UP".

Then, press F.FWD/▶ button.

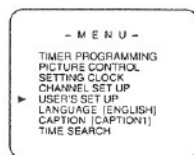

2 Select "ALL" or "BLANK"

Press PLAY/▲ or STOP/▼ button repeatedly to point to "REPEAT PLAY".

Press F.FWD/▶ or REW/◀ button repeatedly until your desired selection [ALL] or [BLANK] appears.

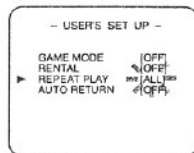

3 Exit the Repeat Play setting

Press MENU button to return to the TV mode.

4 Start playback

Press PLAY button to start the Repeat Play. "REPEAT PLAY▶" appears.

- Once you select the Repeat Play mode, it stays in effect even after you turn off the TV/VCR.
- If the Rental mode is set [ON], the "RENTAL PLAY▶" display has priority.

TO CANCEL THE REPEAT PLAY MODE

Press STOP button to stop playback. And repeat steps [1], then follow step [2] but select [OFF]. Press MENU button to return to the TV mode.

Make sure ...

- You must use the remote control for the following steps.
- Power must be turned on.
- Insert a tape.

COUNTER MEMORY

This feature can be used to memorize a beginning point that you want to review. And you can search it easily by rewinding or fast forwarding.

NOTE: If the All Repeat or Blank Repeat is set to [ON], the Counter Memory function does not work.

1 Stop a tape at your desired point

Rewind or fast forward the tape to the beginning point at which you want to review.

2 Reset the counter to 0:00:00

Press COUNTER RESET button repeatedly.

3 Select the Counter Memory mode

Press COUNTER MEMORY button so that "MEMORY" appears on the display.

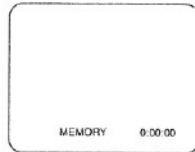

4 Begin recording or playback

Press RECORD or PLAY button.

Press STOP button when recording or playback is completed.

5 To activate the Counter Memory

Press REW (or F.FWD) button. The tape will automatically stop when the counter returns to 0:00:00.

TO CANCEL THE COUNTER MEMORY

First press COUNTER MEMORY to display the counter on the TV/VCR screen. Then press COUNTER MEMORY continuously until "COUNT" appears.

TIME SEARCH

The Time Search function makes it possible to quickly advance the tape to your desired position from any position by entering the exact amount of playback time of the part that you want to skip.

NOTES:

- Time Search is set up to 9 hours 50 minutes (9:50) by 10 minutes at a time.
- This function is not operative in recording mode.
- Counter Memory function is not operative in this mode.
- This function is not operative when a cassette tape is not inserted in the TV/VCR.

In the example below: To watch a program after 2 hour 50 minutes from present position to forward direction.

1 Select "TIME SEARCH" mode

Press TIME SEARCH button

OR

Press MENU button.

Press PLAY/▲ or STOP/▼ button repeatedly to point to "TIME SEARCH".

Then, press F.FWD/▶ button.



2 Enter your desired time

Press PLAY/▲ or STOP/▼ button repeatedly until your desired time appears. (Example: "2:50" for 2 hours 50 minutes)



3 Begin Time Search

Press REW or F.FWD button. The tape will move to the specified point.

The time counts down as the searching progresses. When 0:00 is reached, the tape will start playback automatically.

TO CANCEL THE TIME SEARCH

Press STOP/EJECT button on the TV/VCR or the remote control. This will delete the selected time.

RECORDING

Make sure ...

- Power must be turned on.
- Insert a cassette tape with its erase prevention tab in place. (If necessary, rewind or fast forward the tape to the point at which you want to begin recording.)

NORMAL RECORDING

You can only watch the same TV program that is being recorded.

1 Select the channel to be recorded

Press number buttons on the remote control or the CH ▼ or ▲ button.

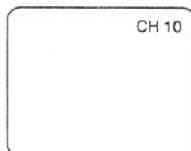

2 Select the tape speed

Press SPEED button to select the desired tape speed (SP/LP/SLP).

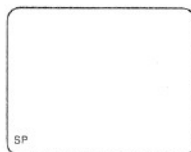

3 Begin recording

Press RECORD button. The REC indicator flashes.

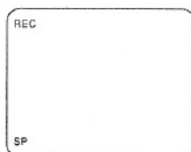

4 Stop recording

Press STOP button when recording is completed.

SKIPPING SOME MATERIALS DURING RECORDING

Press PAUSE/STILL button to temporarily stop recording. The REC indicator flashes.

Press PAUSE/STILL or RECORD button to resume recording.

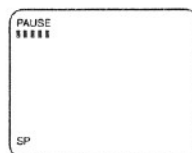

NOTES:

- To prevent tape damage, after five minutes, the TV/VCR will automatically return to the Recording mode.
- When in the Pause/Still mode, a display showing 5 "■" marks will appear on the screen. Each "■" mark represents one minute of Pause time. You may refer to this display for remaining pause time available.
- If "CLOSED CAPTION [ON]" is selected from the "CLOSED CAPTION SET UP" menu, the On Screen Display will appear for 5 seconds, then disappear. If you want to check the remaining pause time available using the On Screen Display, press DISPLAY button. The On Screen Display will appear for 5 seconds.

OTR (One Touch Recording)

This function enables you to set a recording length simply by pressing REC/OTR button on the TV/VCR.

Make sure ...

- Power must be turned on.
- Insert a cassette tape with its erase prevention tab in place. (If necessary, rewind or fast forward the tape to the point at which you want to begin recording.)

NOTE: This function cannot be done by the remote control.

1 Select the channel to be recorded

Press the number buttons on the remote control or the CHANNEL ▼ or ▲ button.

2 Begin OTR

Press REC/OTR button on the TV/VCR as many times as needed. The recording length will be determined by the number of times you press REC/OTR button.

Each additional push will increase the recording time by 30 minutes. It is set up to 8 hours.

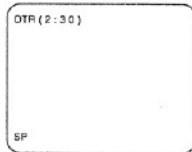

Push(es)	Display	Recording length
1 push		(normal recording)
2 pushes	0:30	30 minutes
3 pushes	1:00	60 minutes
↓	↓	↓
17 pushes	8:00	480 minutes

HINTS:

- Recording starts immediately when the REC/OTR button is pressed.
- When REC/OTR button is pressed 18 times, the TV/VCR will switch to the Normal Recording mode.
- To stop the OTR operation, press STOP button on the TV/VCR or on the remote control.
- To show the remaining time, press DISPLAY button repeatedly until "OTR" appears on the TV screen.
- Recording stops when 0:00 is reached.
- Please note that in the SLP mode maximum recording time, assuming the tape is started at the beginning, is 8 hours using T-160 (or 6 hours using T-120).
- If the tape runs out before the end time, the TV/VCR will switch to the Stop mode immediately, eject the tape and the TV/VCR power will be turned off.

COPYING A VIDEO CASSETTE (Requires another VCR)

You can make copies of video tapes made by friends or relatives for your enjoyment.

WARNING: Unauthorized recordings of copyrighted video tapes may be an infringement of copyright laws.

Connect your TV/VCR and a Source (Playing) VCR using the following diagram.

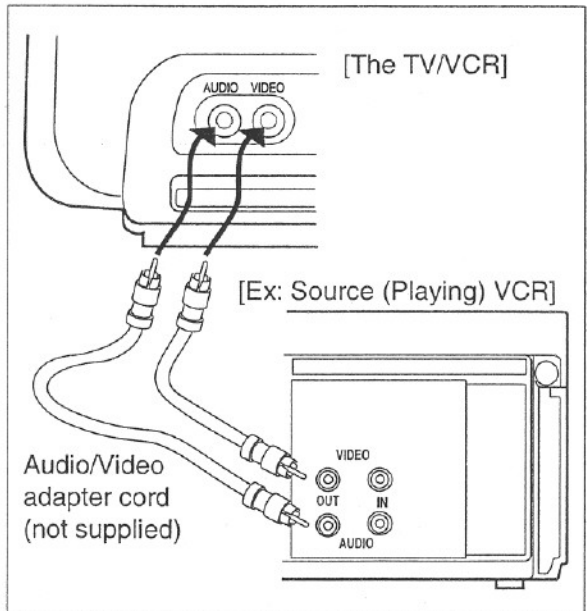

- 1) Insert a pre-recorded video cassette into the Source (Playing) VCR.
- 2) Insert a blank video cassette, or one you want to record over, into the TV/VCR's cassette compartment.
- 3) Press SPEED button to select the desired recording speed (SP, LP or SLP).
- 4) Press CHANNEL ▲ or ▼ button repeatedly so that "AUX" appears on the screen.
- 5) Begin playback of the tape in the Source (Playing) VCR.
- 6) Press RECORD button on the TV/VCR.

NOTE: For best results during dubbing, use the TV/VCR's front panel controls whenever possible. The remote control might affect the Source (Playing) VCR's playback operation.

AUTOMATIC TIMER RECORDING

You may set the TV/VCR to record while you are away. You can set 8 programs to record on a specific day, daily or weekly within a 1 year period.

In the example below, the timer is being set to record:

DATE: MAY 6th, 1997
 SETTING TIME: from 7:30PM to 8:50PM
 CHANNEL: CH61
 TAPE SPEED: LP

NOTES:

- You must use the remote control for this procedure.
- If a cable box or satellite box is connected with the TV/VCR you will be limited to record only one channel. And the channel selector on the TV/VCR must be selected to the output channel of the boxes 3 or 4 and then the actual channel to be recorded must be selected on the boxes.

Make sure ...

- Be sure the clock is set to the correct time and date before setting the timer.
- Power must be turn on to set automatic timer recording.
- Insert a cassette tape with its erase prevention tab in place. (If necessary, rewind or fast forward the tape to the point at which you want to begin recording.)
- The channel you want to record is properly set in advance. (See page 13)

Avoid over lap of programs ...

There is a case that a program will not be performed, when programs overlap;

- The program that the start time is set earlier has priority.
- When the earliest program has finished and the programs which should start still overlap, the recording will start in order of the program number.
- If you programmed as the illustration, the timer recording would be carried out as follows (shaded part is the carried period):

9:00AM - 10:00AM for PROGRAM 2
 10:00AM - for PROGRAM 1

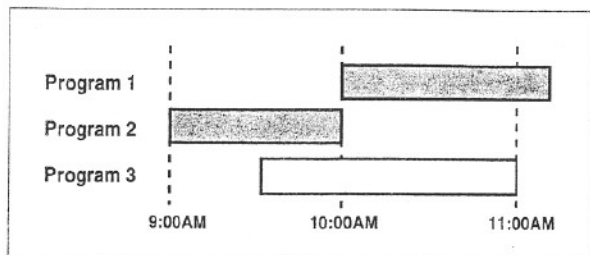

1 Select "TIMER PROGRAMMING"

Press MENU button.

Confirm "TIMER PROGRAMMING" is pointed.

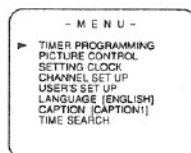

And press F.FWD/▶ button.

- If you did not set the clock, "MANUAL CLOCK SETTING" appears. If so, follow page 15 to set the clock and repeat from step [3].

2 Select your desired program number (1-8)

Press PLAY/▲ or STOP/▼ button repeatedly to select your desired program.

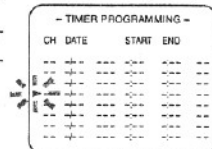

And press F.FWD/▶ button.

3 Set the channel number

Press PLAY/▲ or STOP/▼ button repeatedly until your desired channel number appears. (Example: CH61)

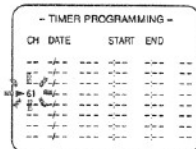

And press F.FWD/▶ button.

4 Select once, every day or weekly recording

For once recording :

Press PLAY/▲ (up) button repeatedly until your desired date appears. (Example: "5/06" for May 6th) And press F.FWD/▶ button.

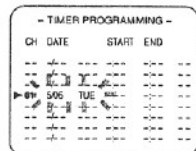

For every day recording : To record a TV program at the same time on the same channel every day. (Example: Monday through Sunday)

Press STOP/▼ (down) button repeatedly until "EVERY DAY" appears. And press F.FWD/▶ button.

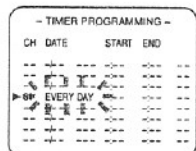

For weekly recording : To record a TV program at the same time on the same channel every week. (Example: every Monday on channel 7 at 5:00PM)

Press STOP/▼ (down) button repeatedly until "EVERY" and your desired day of the week appear together. And press F.FWD/▶ button.

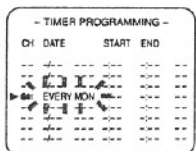

5 Set start hour

Press PLAY/▲ or STOP/▼ button repeatedly until your desired hour appears. (Example: " 7, PM" for 7:30PM)

And press F.FWD/▶ button.

- TIMER PROGRAMMING -			
CH	DATE	START	END
--	--	--	--
--	--	--	--
--	--	--	--
▶ 01	506	TUE	7:30PM
--	--	--	--
--	--	--	--
--	--	--	--
--	--	--	--

6 Set start minute

Press PLAY/▲ or STOP/▼ button repeatedly until your desired minute appears. (Example: "30" for 7:30PM)

And press F.FWD/▶ button.

- TIMER PROGRAMMING -			
CH	DATE	START	END
--	--	--	--
--	--	--	--
--	--	--	--
▶ 01	506	TUE	7:30PM
--	--	--	--
--	--	--	--
--	--	--	--
--	--	--	--

7 Set end hour

Press PLAY/▲ or STOP/▼ button repeatedly until your desired hour appears. (Example: "8, PM" for 8:50PM)

And press F.FWD/▶ button.

- TIMER PROGRAMMING -			
CH	DATE	START	END
--	--	--	--
--	--	--	--
--	--	--	--
▶ 01	506	TUE	7:30PM 8:30PM
--	--	--	--
--	--	--	--
--	--	--	--
--	--	--	--

8 Set end minute

Press PLAY/▲ or STOP/▼ button repeatedly until your desired minute appears. (Example: "50" for 8:50PM)

And press F.FWD/▶ button.

- TIMER PROGRAMMING -			
CH	DATE	START	END
--	--	--	--
--	--	--	--
--	--	--	--
▶ 01	506	TUE	7:30PM 8:50PM
--	--	--	--
--	--	--	--
--	--	--	--
--	--	--	--

9 Set the tape speed

Press PLAY/▲ or STOP/▼ button repeatedly until your desired tape speed appears. (Example: LP)

- TIMER PROGRAMMING -			
CH	DATE	START	END
--	--	--	--
--	--	--	--
--	--	--	--
▶ 01	506	TUE	7:30PM 8:50PM LP
--	--	--	--
--	--	--	--
--	--	--	--
--	--	--	--

10 Finish setting the program

Press F.FWD/▶ or REW/◀ button. Program 4 is now completed.

To set another program, repeat steps [2] to [10].

11 Set the timer

Press POWER button to set automatic timer recording. The TIMER REC indicator lights up.

- You must turn off the TV/VCR to activate automatic timer recording.

If power is not turned off and you continue watching TV, "TIMER REC STANDBY" starts flashing on the TV screen 2 minutes before the programmed start time.

TO CORRECT A PROGRAM

- While setting a program; press REW/◀ button to go back one step, and enter correct numbers using PLAY/▲ or STOP/▼ button.
- After setting a program;
 - 1) Press POWER button.
 - 2) Repeat steps [1] - [2].
 - 3) Press F.FWD/▶ button repeatedly (or press REW/◀ button to go back one step) until a digit you want to correct flashes and make changes.
 - 4) Press POWER button to set automatic timer recording.

TO CANCEL AN AUTOMATIC TIMER RECORDING

- While setting or after setting a program;
 - 1) Press POWER button.
 - 2) Repeat steps [1] ~ [2] and select a program you want to cancel.
 - 3) Press T-PROG. CLEAR button.
 - 4) Press MENU button to return to the TV mode.
- While recording is in progress;
 - 1) Press POWER button.
 - 2) Press STOP/EJECT button on the TV/VCR.

If you press POWER button to turn off before the end time, timer recording will continued. Repeat steps [1] ~ [2], select a program you want to cancel and press T-PROG. CLEAR button. Press MENU button to return to the TV mode.

TO CHECK THE START/END TIME

- 1) Press POWER button so that the REC indicator goes off.
- 2) Press MENU button on the remote control.
- 3) Confirm "TIMER PROGRAMMING" is pointed.
- 4) Press F.FWD/▶ button. The details of programs appear on the TV screen.
- 5) Press MENU button. The TV screen returns to the TV mode.

HINTS:

- Make sure the channel you want to record is properly set in advance.
- It is not necessary to press RECORD button for timer recording.
- Recording begins automatically at the set of the Start time.
- If you are recording using a Timer mode, you may not operate the unit manually.
- The erase-prevention tab on the cassette must be in place (or you must put tape over the hole).
- If the erasure protection tab is removed, the cassette will be ejected when the POWER button is pressed to off.
- If the tape runs out before the end time, the TV/VCR will switch to the Stop mode immediately, and the tape will be ejected.

AUTO RETURN

With this feature, after finished timer recording, the beginning of the recorded program(s) can be searched automatically.

1 Select "USER'S SET UP"

Press MENU button.

Press PLAY/▲ or STOP/▼ button repeatedly to point to "USER'S SET UP".

And press F.FWD/▶ button.

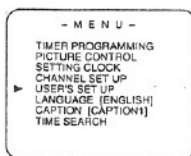

2 Set "AUTO RETURN" to [ON]

Press PLAY/▲ or STOP/▼ button repeatedly to point to "AUTO RETURN".

Press F.FWD/▶ or REW/◀ button repeatedly until [ON] appears.

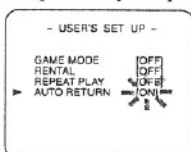

3 Auto Return will begin

When all the timer recordings are completed, the TV/VCR will rewind to the beginning of the recorded program(s).

NOTES:

- If you press POWER button during rewinding a tape, the Auto Return will be stopped.
- The Counter Memory function does not operate in this mode.

4 Watch the recorded program

Press PLAY button.

SLEEP TIMER

The Sleep Timer function make the TV/VCR turn off without using the POWER button after a desired time period.

Press SLEEP button on the remote control repeatedly until your desired sleep time appears.

Each additional push will increase the time by 30 minutes. It is set up to 120 minutes.

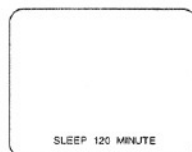

	DISPLAY	SLEEP TIME
1 push	0 MINUTE	0 minute
2 pushes	30 MINUTE	30 minutes
3 pushes	60 MINUTE	60 minutes
4 pushes	90 MINUTE	90 minutes
5 pushes	120 MINUTE	120 minutes
6 pushes	0 MINUTE	0 minute

TO CANCEL THE SLEEP TIMER

Press SLEEP button repeatedly until "SLEEP 0 MINUTE" appears.

TROUBLESHOOTING GUIDE

If you have followed the instructions contained in this manual and have difficulty in operating your TV/VCR, locate the SYMPTOM in the left column below. Check the corresponding POSSIBLE CAUSE and CORRECTIVE ACTION columns to remedy the problem.

SYMPTOM	POSSIBLE CAUSE	CORRECTIVE ACTION
No power.	<ul style="list-style-type: none"> • AC Power cord is not connected. • POWER button is set to OFF. 	<ul style="list-style-type: none"> • Connect AC power cord to AC outlet. • Set the POWER button to ON.
No picture and sound.	<ul style="list-style-type: none"> • TV/VCR is not plugged into an active AC outlet. • Antenna is not connected. • No channel in memory. 	<ul style="list-style-type: none"> • Plug power cord into an active AC outlet. • Check antenna connection. • Program tuner's memory.
No picture or poor picture on TV/VCR.	<ul style="list-style-type: none"> • Direction or condition of antenna is not adequate. • Picture control is not adequate. 	<ul style="list-style-type: none"> • Adjust direction or replace antenna. • Adjust picture controls.
No sound or poor sound.	<ul style="list-style-type: none"> • Volume control on remote control unit or main unit is in minimum position. • MUTE button on the remote control unit is in the ON position. 	<ul style="list-style-type: none"> • Adjust volume control on remote control unit or set. • Press MUTE button.
Timer recording is not possible.	<ul style="list-style-type: none"> • The timer recording is set incorrectly. • The timer recording is not set to ON. 	<ul style="list-style-type: none"> • Set the timer recording correctly. • Set the timer recording to ON.
Cannot go into Record mode.	<ul style="list-style-type: none"> • The erase-prevention tab on cassette is missing. 	<ul style="list-style-type: none"> • Place transparent tape over missing erase-prevention tab.
Playback picture is partially noisy.	<ul style="list-style-type: none"> • The tracking control is not set correctly. 	<ul style="list-style-type: none"> • Adjust tracking control for better picture.
No picture but the audio is OK in playback.	<ul style="list-style-type: none"> • Video heads are dirty. 	<ul style="list-style-type: none"> • Head cleaning is necessary, consult the nearest Funai Service Center.
No operation by infrared Remote Control.	<ul style="list-style-type: none"> • No power to TV/VCR. • Weak batteries. 	<ul style="list-style-type: none"> • Make sure the AC cord is connected to an AC outlet. • Check the batteries in infrared Remote Control.
Video or color fades in and out when making a copy of a video tape.	<ul style="list-style-type: none"> • You are copying a copyrighted video tape and are experiencing copy guard protection. 	<ul style="list-style-type: none"> • None.

CLOSED CAPTION PROBLEM	POSSIBLE REMEDY
My TV/VCR is showing captions that are misspelled.	You are watching a live broadcast and spelling errors made by the closed captioning production company may pass through uncorrected. A prerecorded program will not show any misspelled words because of the normal time available for editing the captions.
My TV/VCR will not show the text in its entirety or there is a delay of what is being said.	Captions that are delayed a few seconds behind the actual dialogue are common for live broadcasts. Most captioning production companies can display a dialogue to a maximum of 220 words per minute. If a dialogue exceeds that rate, selective editing is used to insure that the captions remain up-to-date with the current TV screen dialogue.
My captions are scrambled with white boxes on the TV screen.	Interference caused by building, power lines, thunderstorms, etc. may cause scrambled or incomplete captions to appear.
My program guide listed a TV show as being closed captioned but none of the captions were displayed.	Broadcasters may at times use a time compression process to speed up the actual program so that additional advertising time can be given. Since the decoder cannot read the compressed information, captions will be lost.
My prerecorded video tape does not show any captions. The tape box mentions it being closed captioned.	The video tape was either an illegal copy or the tape duplicating company accidentally left out the captioning signals during the copying process.
My TV screen shows a black box on certain channels.	You are in the TEXT mode. Select CAPTION mode or CAPTION [OFF].

MAINTENANCE

CABINET CLEANING

- Wipe the front panel and other exterior surfaces of the TV/VCR with a soft cloth immersed in lukewarm water and wrung dry.
- Never use a solvent or alcohol. Do not spray insecticide liquid near the TV/VCR. Such chemicals may cause damage and discoloration to the exposed surfaces.

HEAD CLEANING

- Picture playback may become blurred or interrupted while the TV program reception is clear. This does not mean that the recorded program has been erased. Dirt accumulated on the video heads after long periods of tape playback, or the usage of rental or worn tapes can cause this problem. In this case, video head cleaning requires highly technical attention, therefore consult the nearest Funai Authorized Service Center. Clean heads only when problems occur.

SERVICING

- Should your TV/VCR become inoperative, do not try to correct the problem by yourself. There are no user-serviceable parts inside. Turn off, unplug the power cord, and take the unit to the nearest Funai Authorized Service Center for servicing.

SPECIFICATIONS

GENERAL SPECIFICATIONS

CRT : 13 inch in-line gun, 90° deflection tube
 Television system : NTSC-M
 Closed caption system : §15.119/FCC
 Video Heads : Rotary two-head
 Tape width : 1/2 inch
 Tape speed
 SP : 33.40mm/sec.
 LP : 16.67mm/sec.
 SLP : 11.12mm/sec.
 Tuner channel
 TV VHF Low : #2-#6
 TV VHF High : #7-#13
 TV UHF : #14-#69
 CATV
 VHF : 5A
 MID band : A5~A1, A~I
 SUPER band : J~W
 HYPER band : W+1~W+84
 Terminals
 Antenna input : VHF/UHF 75 ohms unbalanced
 Video input : RCA connector × 1
 Audio input : RCA connector × 1
 Earphone : 1/8" monaural (3.5 mm)

ELECTRICAL SPECIFICATIONS

Video input level : 0.5~2.0V_{p-p}
 Audio input level : -15dBs
 Video S/N ratio : More than 46dB
 Audio S/N ratio : More than 43dB

OTHER SPECIFICATIONS

Power requirement : AC 120V/60Hz
 Power consumption : 75W
 Dimensions : H : 15-13/16" (402mm)
 W : 15-3/16" (386mm)
 D : 14-3/4" (375mm)
 Weight : 27.5 lbs (12.5 kg)

- Designs and specifications are subject to change without notice and without our legal obligation.

CABLE CHANNEL DESIGNATIONS

If you subscribe to cable TV, the channels are displayed as 1-125. Cable companies often designate channels with letters or letter-number combinations. Please check with your local cable company. The following is a chart of common cable channel designations.

CATV channel	5A	2	3	4	5	6	7	8	9	10	11	12	13	A	B
TV Display	1	2	3	4	5	6	7	8	9	10	11	12	13	14	15
CATV channel	C	D	E	F	G	H	I	J	K	L	M	N	O	P	Q
TV Display	16	17	18	19	20	21	22	23	24	25	26	27	28	29	30
CATV channel	R	S	T	U	V	W	W+1	W+2	W+3	W+4	W+5	W+6	W+7	W+8	W+9
TV Display	31	32	33	34	35	36	37	38	39	40	41	42	43	44	45
CATV channel	W+10	W+11	W+12	W+13	W+14	W+15	W+16	W+17	W+18	W+19	W+20	W+21	W+22	W+23	W+24
TV Display	46	47	48	49	50	51	52	53	54	55	56	57	58	59	60
CATV channel	W+25	W+26	W+27	W+28	W+29	W+30	W+31	W+32	W+33	W+34	W+35	W+36	W+37	W+38	W+39
TV Display	61	62	63	64	65	66	67	68	69	70	71	72	73	74	75
CATV channel	W+40	W+41	W+42	W+43	W+44	W+45	W+46	W+47	W+48	W+49	W+50	W+51	W+52	W+53	W+54
TV Display	76	77	78	79	80	81	82	83	84	85	86	87	88	89	90
CATV channel	W+55	W+56	W+57	W+58	A-5	A-4	A-3	A-2	A-1	W+59	W+60	W+61	W+62	W+63	W+64
TV Display	91	92	93	94	95	96	97	98	99	100	101	102	103	104	105
CATV channel	W+65	W+66	W+67	W+68	W+69	W+70	W+71	W+72	W+73	W+74	W+75	W+76	W+77	W+78	W+79
TV Display	106	107	108	109	110	111	112	113	114	115	116	117	118	119	120
CATV channel	W+80	W+81	W+82	W+83	W+84										
TV Display	121	122	123	124	125										