

OWNER'S MANUAL

VIDEO CASSETTE RECORDER 6480

Symphonic

TABLE OF CONTENTS

IMPORTANT SAFEGUARDS	2
PRECAUTIONS.....	4
FEATURES.....	5
SUPPLIED ACCESSORIES.....	5
OPERATING CONTROLS AND FUNCTIONS.....	6
REMOTE CONTROL OPERATION.....	8
HOW TO USE THE REMOTE CONTROL.....	8
INSTALLING THE BATTERIES.....	9
CABLE CONNECTIONS.....	10
COMBINATION VHF/UHF ANTENNA, CATV COAXIAL CABLE.....	10
SEPARATE VHF (75-OHM) / UHF (300-OHM) ANTENNA.....	11
SEPARATE UHF/VHF (300-OHM) ANTENNA.....	11
A/V TERMINALS.....	12
USING A CATV CONVERTER BOX.....	13
CONTROLLING VCR INPUT & OUTPUT.....	13
VIDEO OUTPUT CHANNEL SETTING (BACK OF VCR).....	13
INPUT SELECT.....	13
CHANNEL MEMORY PROGRAMMING (Preset).....	14
TO CANCEL, ADD PRESET CHANNEL.....	15
SETTING THE CLOCK.....	16
VIEWING AND RECORDING THE SAME PROGRAM.....	18
RECORDING ONE PROGRAM WHILE VIEWING ANOTHER.....	19
AUTOMATIC TIMER RECORDING.....	19
TODAY TIMER RECORDING.....	24
OTR (ONE TOUCH RECORDING).....	26
MONITORING RECORDING.....	26
VIEWING ONLY TV (WITHOUT RECORDING).....	27
PLAYBACK.....	27
COUNTER MEMORY.....	28
SPECIAL FEATURES.....	29
VIDEO CASSETTE TAPE.....	30
TROUBLESHOOTING GUIDE.....	31
MAINTENANCE.....	32
CABINET CLEANING.....	32
HEAD CLEANING.....	32
SERVICING.....	32
SPECIFICATIONS.....	33
GENERAL SPECIFICATIONS.....	33
ELECTRICAL SPECIFICATIONS.....	33
OTHER SPECIFICATIONS.....	33
CABLE CHANNEL DESIGNATIONS.....	34

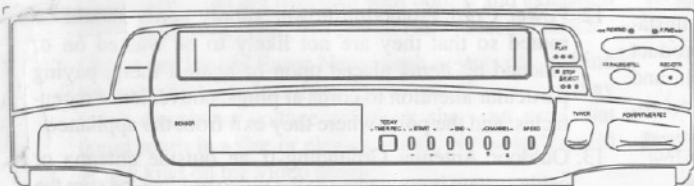

VHS

Please read before using this equipment

WARNING:

TO REDUCE THE RISK OF FIRE OR ELECTRIC SHOCK, DO NOT EXPOSE THIS APPLIANCE TO RAIN OR MOISTURE.

**CAUTION**

RISK OF ELECTRIC SHOCK
DO NOT OPEN



CAUTION: TO REDUCE THE RISK OF ELECTRIC SHOCK, DO NOT REMOVE COVER (OR BACK) NO USER SERVICEABLE PARTS INSIDE. REFER SERVICING TO QUALIFIED SERVICE PERSONNEL.



THIS SYMBOL INDICATES THAT DANGEROUS VOLTAGE CONSTITUTING A RISK OF ELECTRIC SHOCK IS PRESENT WITHIN THIS UNIT.



THIS SYMBOL INDICATES THAT THERE ARE IMPORTANT OPERATING AND MAINTENANCE INSTRUCTIONS IN THE LITERATURE ACCOMPANYING THE APPLIANCE.

The important note is located on the rear of the cabinet.

IMPORTANT SAFEGUARDS

1. Read instructions-All the safety and operating instructions should be read before the appliance is operated.
2. Retain Instructions-The safety and operating instructions should be retained for future reference.
3. Heed Warnings-All warnings on the appliance and in the operating instructions should be adhered to.
4. Follow Instructions-All operating and use instructions should be followed.

5. Cleaning-Unplug this video product from the wall outlet before cleaning. Do not use liquid cleaners or aerosol cleaners. Use a damp cloth for cleaning.

EXCEPTION: A product that is meant for uninterrupted service and that for some specific reason, such as the possibility of the loss of an authorization code for a CATV converter, is not intended to be unplugged by the user for cleaning or any other purpose, may exclude the reference to unplugging the appliance in the cleaning description otherwise required in item 5.

6. Attachments-Do not use attachments not recommended by the video product manufacturer as they may cause hazards.
7. Water and Moisture-Do not use this video product near water, for example, near a bath tub, wash bowl, kitchen sink, or laundry tub, in a wet basement, or near a swimming pool, and the like.

8. Accessories-Do not place this video product on an unstable cart, stand, tripod, bracket, or table. The video product may fall, causing serious injury to a child or adult, and serious damage to the appliance. Use only with a cart, stand, tripod, bracket, or table recommended by the manufacturer, or sold with the video product. Any mounting of the appliance should follow the manufacturer's instructions and should use a mounting accessory recommended by the manufacturer. An appliance and cart combination should be moved with

PORTABLE CART WARNING
(Symbol provided by RETAC)



S3125A

care. Quick stops, excessive force, and uneven surfaces may cause the appliance and cart combination to overturn.

9. Ventilation-Slots and openings in the cabinet are provided for ventilation and to ensure reliable operation of the video product and to protect it from overheating, and these openings must not be blocked or covered. The openings should never be blocked by placing the video product on a bed, sofa, rug, or other similar surface. This video product should not be placed in a built-in installation such as a bookcase or rack unless proper ventilation is provided or the manufacturer's instructions have been adhered to.
10. Power Sources-This video product should be operated only from the type of power source indicated on the marking label. If you are not sure of the type of power supply to your home, consult your appliance dealer or local power company. For products intended to operate from battery power, or other sources, refer to the operating instructions.
11. Grounding or Polarization-This video product is equipped with a polarized alternating-current line plug (a plug having one blade wider than the other). This plug will fit into the power outlet only one way. This is a safety feature. If you are unable to insert the plug fully into the outlet, try reversing the plug. If the plug should still fail to fit, contact your electrician to replace your obsolete outlet. Do not defeat the safety purpose of the polarized plug.
12. Power Cord Protection-Power supply cords should be routed so that they are not likely to be walked on or pinched by items placed upon or against them, paying particular attention to cords at plugs, convenience receptacles, and the point where they exit from the appliance.
13. Outdoor Antenna Grounding-If an outside antenna or cable system is connected to the video product, be sure the antenna or cable system is grounded so as to provide some protection against voltage surges and built-up static charges. Article 810 of the National Electrical Code, ANSI/NFPA No. 70-1984, provides information with regard to proper grounding of the mast and supporting structure, grounding of the lead-in wire to an antenna discharge unit, size of grounding conductors, location of

FIGURE A

EXAMPLE OF ANTENNA GROUNDING AS PER NATIONAL ELECTRICAL CODE

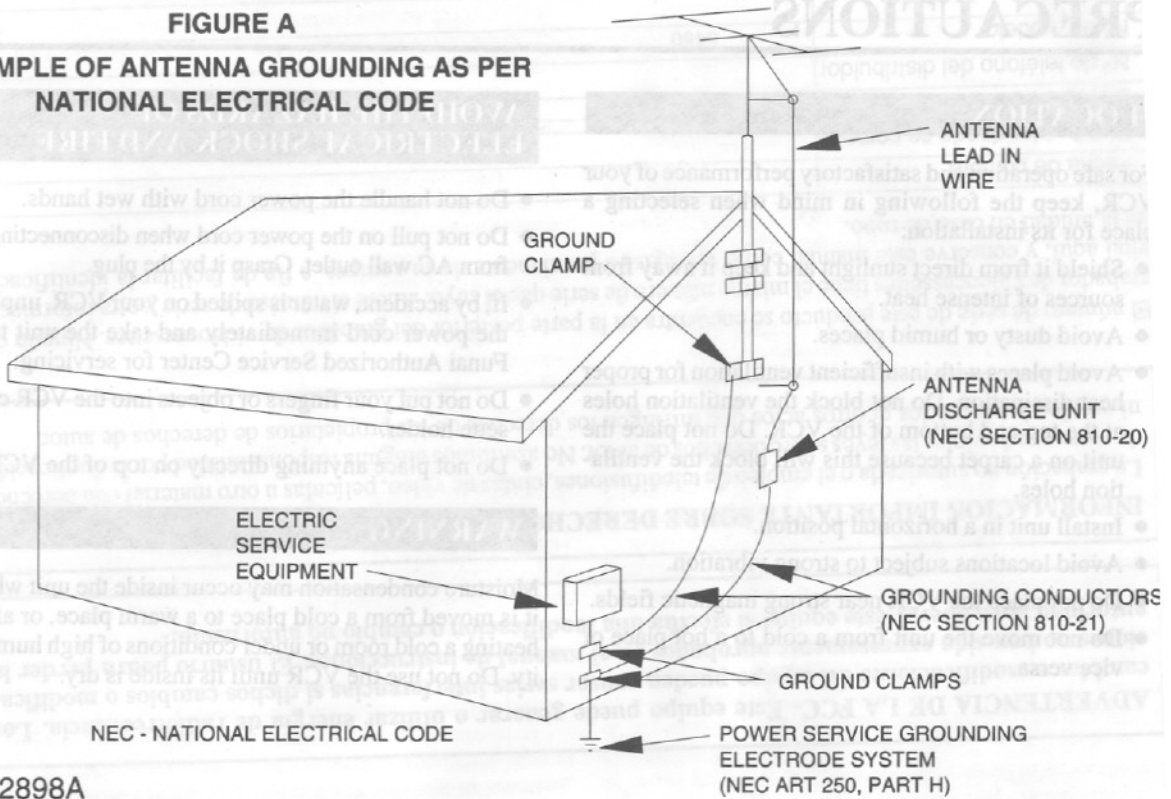

S2898A

antenna-discharge unit, connection to grounding electrodes, and requirements for the grounding electrode. (Fig. A)

14. **Lightning**-For added protection for this video product during a lightning storm, or when it is left unattended and unused for long periods of time, unplug it from the wall outlet and disconnect the antenna or cable system. This will prevent damage to the video product due to lightning and power-line surges.
15. **Power Lines**-An outside antenna system should not be located in the vicinity of overhead power lines or other electric light or power circuits, or where it can fall into such power lines or circuits. When installing an outside antenna system, extreme care should be taken to keep from touching such power lines or circuits as contact with them might be fatal.
16. **Overloading**-Do not overload wall outlets and extension cords as this can result in a risk of fire or electric shock.
17. **Object and Liquid Entry**-Never push objects of any kind into this video product through any openings as they may touch dangerous voltage points or short-out parts that could result in a fire or electric shock. Never spill liquid of any kind on the video product.
18. **Servicing**-Do not attempt to service this video product yourself as opening or removing covers may expose you to dangerous voltage or other hazards. Refer all servicing to qualified service personnel.
19. **Damage Requiring Service**-Unplug this video product from the wall outlet and refer servicing to qualified service personnel under the following conditions:

- a. When the power-supply cord or plug is damaged.
- b. If liquid has been spilled, or objects have fallen into the video product.
- c. If the video product has been exposed to rain or water.
- d. If the video product does not operate normally by following the operating instructions. Adjust only those controls that are covered by the operating instructions as an improper adjustment of other controls may result in damage and will often require extensive work by a qualified technician to restore the video product to its normal operation.
- e. If the video product has been dropped or damaged in any way.
- f. When the video product exhibits a distinct change in performance-this indicates a need for service.
20. **Replacement Parts**-When replacement parts are required, be sure the service technician has used replacement parts specified by the manufacturer or have the same characteristics as the original part. Unauthorized substitutions may result in fire, electric shock or other hazards.
21. **Safety Check**-Upon completion of any service or repairs to this video product, ask the service technician to perform safety checks to determine that the video product is in proper operating condition.
22. **Heat**-This video products should be situated away from heat sources such as radiators, heat registers, stoves, or other products (including amplifiers) that produce heat.

PRECAUTIONS

LOCATION

For safe operation and satisfactory performance of your VCR, keep the following in mind when selecting a place for its installation:

- Shield it from direct sunlight and keep it away from sources of intense heat.
- Avoid dusty or humid places.
- Avoid places with insufficient ventilation for proper heat dissipation. Do not block the ventilation holes at the top and bottom of the VCR. Do not place the unit on a carpet because this will block the ventilation holes.
- Install unit in a horizontal position.
- Avoid locations subject to strong vibration.
- Do not place the VCR near strong magnetic fields.
- Do not move the unit from a cold to a hot place or vice versa.

AVOID THE HAZARDS OF ELECTRICAL SHOCK AND FIRE

- Do not handle the power cord with wet hands.
- Do not pull on the power cord when disconnecting it from AC wall outlet. Grasp it by the plug.
- If, by accident, water is spilled on your VCR, unplug the power cord immediately and take the unit to a Funai Authorized Service Center for servicing.
- Do not put your fingers or objects into the VCR cassette holder.
- Do not place anything directly on top of the VCR.

WARNING

Moisture condensation may occur inside the unit when it is moved from a cold place to a warm place, or after heating a cold room or under conditions of high humidity. Do not use the VCR until its inside is dry.

FCC WARNING- This equipment may generate or use radio frequency energy. Changes or modifications to this equipment may cause harmful interference unless the modifications are expressly approved in the instruction manual. The user could lose the authority to operate this equipment if an unauthorized change or modification is made.

IMPORTANT COPYRIGHT INFORMATION

Unauthorized recording or use of broadcast television programming, video tape, film or other copyrighted material may violate applicable copyright laws. We assume no responsibility for the unauthorized duplication, use or other acts which infringe upon the rights of copyright owners.

The serial number of this product may be found on the back of the VCR. No others have the same serial number as yours. You should record the number and other vital information here and retain this book as a permanent record of your purchase to aid identification in case of theft.

Date of Purchase	
Dealer Purchase from	
Dealer Address	
Dealer Phone No.	
Model No.	6480
Serial No.	

FEATURES

- **Auto Power On and Off system**— Automatically turns the VCR on as you insert the cassette, and turns off after auto-rewind, ejects when reaches beginning of the tape.
- **Automatic Rewind**— Automatically rewinds at the end of the tape except during timer recording.
- **Auto Tracking**— Adjusts the tracking automatically for each tape you play.
- **Three Different Record/Playback Speeds**— Select the Standard Play (SP mode), Long Play (LP mode) or Super Long Play (SLP mode) for up to eight hours of recording/playback with a T-160 tape.
- **Automatic Playback Speed Selection**— Automatically selects the proper playback speed.
- **1 Year, 8 events (including Today, Daily and Weekly Timer Recording)**— The built-in timer allows you to record up to 7 programs at different times on different channels up to 1 year in advance. The Today Timer Recording feature uses program number 8. The daily timer allows recordings to be made of daily broadcasts, and the weekly timer allows recording to be made once a week up to the end of the tape.
- **Today Timer Recording**— Allows you to easily record one program within 24 hours.

- **OTR (One Touch Recording)**— Instant timed recording from 30 to 480 minutes is possible at the push of OTR button.
- **2 Step Picture Search Operation**— You may view a video program at a high speed or super high speed in either a forward or reverse direction in LP and SLP mode.
- **STILL**— "Freeze" the picture at any time, for close viewing of a particular scene. Only tapes recorded in SLP mode will show a clear picture.
- **181 Channel Cable-compatible PLL Frequency Synthesizer Tuner with Direct Station Call**— (A converter may be necessary to view scrambled CATV channels.)
- **Infrared Remote Control**— Allows you to use most of the controls from a remote location.
- **Real Time Tape Counter**— This shows the elapsed recording or playback time in hours, minutes, and seconds. The "-" indication will appear when the tape is rewound further than the tape counter position "0:00:00".
- **Direct Button Operation**— When a tape is in the VCR and the power is off, just pressing PLAY, REWIND or F.FWD button on the main unit will automatically turn on the VCR and playback, rewinding or fast-forwarding will start immediately.

SUPPLIED ACCESSORIES

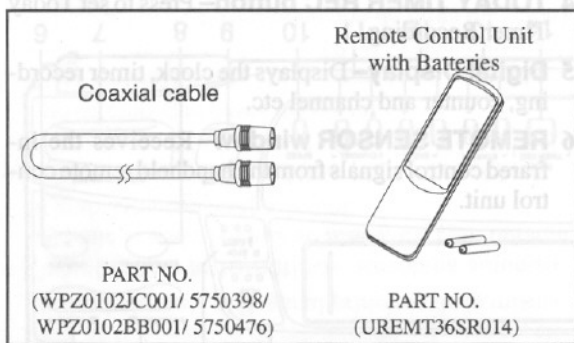

Coaxial cable

PART NO.
(WPZ0102JC001/ 5750398/
WPZ0102BB001/ 5750476)

Remote Control Unit
with Batteries

PART NO.
(UREMT36SR014)

NOTES:

- If you need to replace these accessories, please refer to the PART NO. under the illustrations and contact the Funai parts department for ordering.
- Depending on your antenna system, you may need different types of Combiners (Mixer) or Separators (Splitter). Contact your local electronics store for these items.

OPERATING CONTROLS AND FUNCTIONS

—FRONT VIEW—

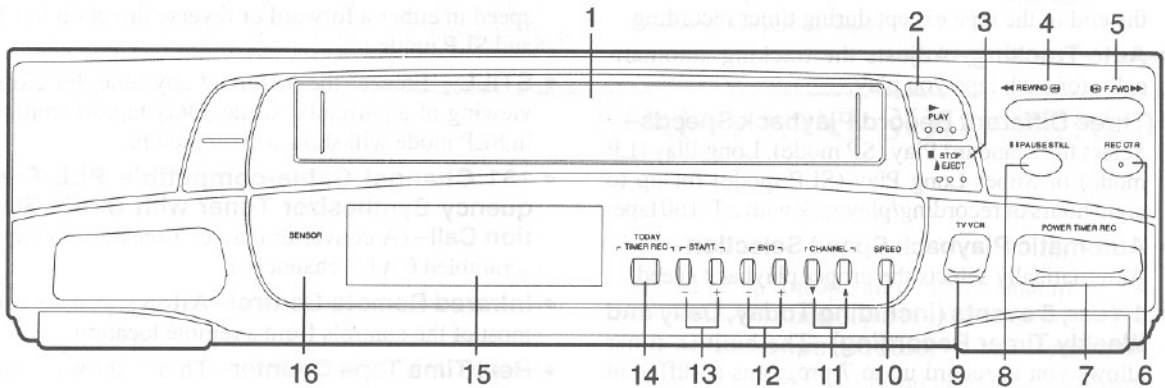

1 **Cassette Compartment**

2 **PLAY button**— Press to begin playback of a tape.

3 **STOP/EJECT button**— Press to stop tape motion. Press to remove tape from VCR.

4 **REWIND button**— Press to rewind tape or to view video in reverse at a faster than normal speed. Press PLAY button to return VCR to normal playback speed.

5 **F.FWD button**— Press to advance tape or to view video in forward direction at a faster than normal speed. Press PLAY button to return VCR to normal playback speed.

6 **REC/OTR button**— Press to begin manual recording and activate one touch recording mode.

7 **POWER/TIMER REC button**— Press to turn VCR on and off. Press to activate the automatic timer recording.

8 **PAUSE/STILL button**— Press to temporarily stop tape during playback or manual recording.

9 **TV/VCR button**— Press to select the signal source that your TV will receive.

VCR position: to view playback, to monitor video recordings or watch TV using the VCR tuner.

TV position: to watch TV or to view one program while recording another.

10 **SPEED button**— Press to set desired tape speed.

11 **CHANNEL buttons**— Press to select the channel for viewing or recording.

TRACKING function— Press ▲ or ▼ to minimize video 'noise' (lines or dots on screen) during tape playback.

12 **END buttons**— Press to select desired end time by pressing "+" or "-" button in the Today Timer Rec mode.

13 **START buttons**— Press to select desired start time by pressing "+" or "-" button in the Today Timer Rec mode.

14 **TODAY TIMER REC button**— Press to set Today Timer Recording.

15 **Digital Display**— Displays the clock, timer recording, counter and channel etc.

16 **REMOTE SENSOR window**— Receives the infrared control signals from the handheld remote control unit.

—REAR VIEW AND TERMINALS—

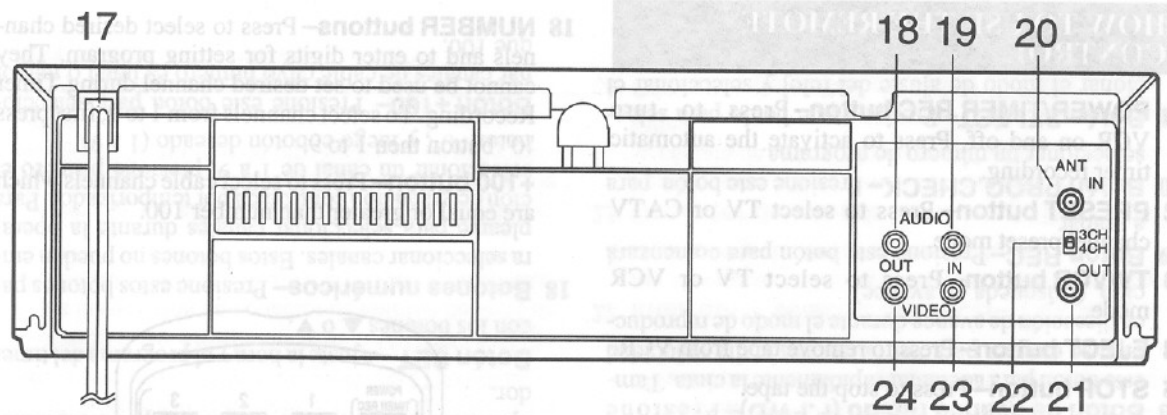

or

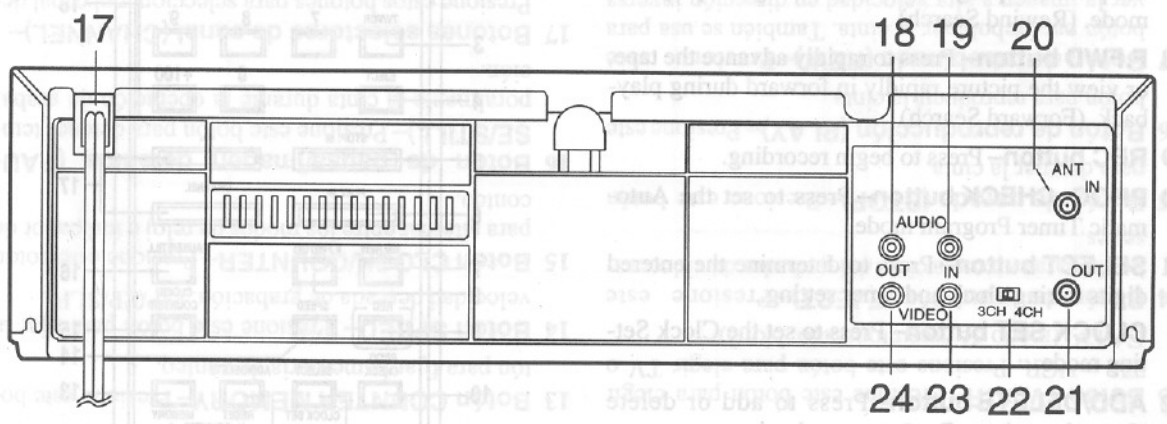

- 17 **Power cord**—Connect to a standard AC outlet (120V/60Hz).
- 18 **AUDIO OUT jack**—For connection to the line in jack of your audio equipment or another VCR.
- 19 **AUDIO IN jack**—For connection to audio output jack of your audio equipment or another VCR.
- 20 **ANT. IN terminal**—For connection to an antenna or CATV.

- 21 **ANT. OUT terminal**—For connection to an antenna in terminal of your TV.
- 22 **3CH/4CH selector switch**—Use to select the video output channel (3 or 4) for playback from the VCR.
- 23 **VIDEO IN jack**—For connection to video output jack of your video camera or another VCR.
- 24 **VIDEO OUT jack**—For connection to the video in jack of video processor or another VCR.

REMOTE CONTROL OPERATION

You can operate most of your VCR's functions from the Remote Control (included). The buttons on the Remote Control have the same functions as the corresponding buttons on the VCR.

HOW TO USE THE REMOTE CONTROL

- 1 **POWER/TIMER REC button**— Press to turn VCR on and off. Press to activate the automatic timer recording.
- 2 **PRESET button**— Press to select TV or CATV channel preset mode.
- 3 **TV/VCR button**— Press to select TV or VCR mode.
- 4 **EJECT button**— Press to remove tape from VCR.
- 5 **STOP button**— Press to stop the tape.
- 6 **PLAY button**— Press to playback the tape.
- 7 **REW button**— Press to rewind the tape or to view the picture rapidly in reverse, during the playback mode. (Rewind Search)
- 8 **F.FWD button**— Press to rapidly advance the tape, or view the picture rapidly in forward during playback. (Forward Search)
- 9 **REC button**— Press to begin recording.
- 10 **PROG. CHECK button**— Press to set the Automatic Timer Program mode.
- 11 **SELECT button**— Press to determine the entered digits during clock and timer setting.
CLOCK SET button— Press to set the Clock Setting mode.
- 12 **ADD/DELETE button**— Press to add or delete channel numbers. Press to cancel a timer program.
COUNTER RESET button— Press to reset counter to 0:00:00.
- 13 **COUNTER MEMORY button**— Press to set counter memory on and off.
- 14 **SPEED button**— Press to set desired recording speed. (SP/LP/SLP)
- 15 **CLOCK/COUNTER button**— Press to alternate between clock and counter display modes.
- 16 **PAUSE/STILL button**— Press to temporarily stop the tape during recording or to view a still picture during playback.
- 17 **CHANNEL buttons**— Press to select desired channel by using either "▲" or "▼" button. They cannot be used during Timer Recording.
- SET function**— Press to adjust time using "▲" or "▼" button.

- 18 **NUMBER buttons**— Press to select desired channels and to enter digits for setting program. They cannot be used to set desired channel during Timer Recording. To select channels from 1 to 9, first press "0" button then 1 to 9.
+100 button— Press to select cable channels which are equal or greater than number 100.

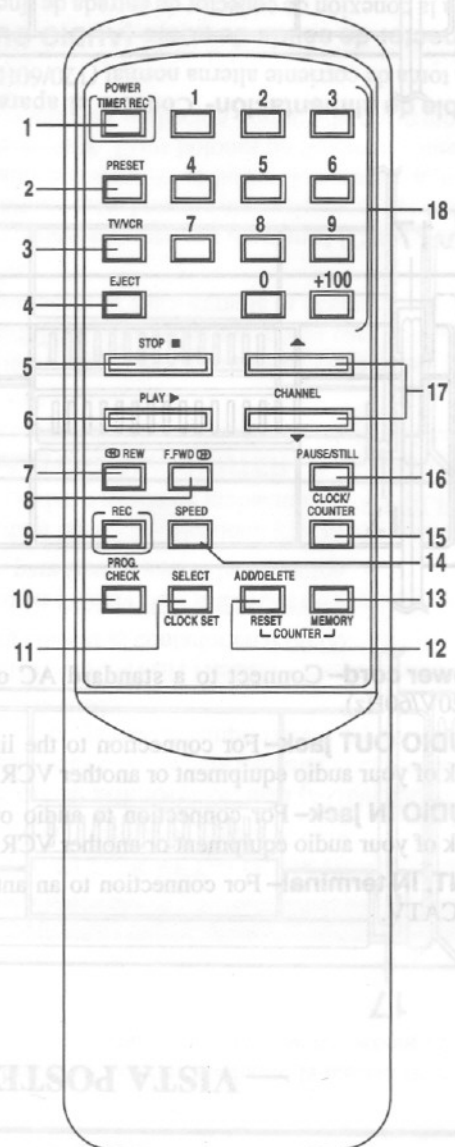

INSTALLING THE BATTERIES

1

Open the battery compartment cover by pressing the cover on the remote unit in the direction of the arrow.

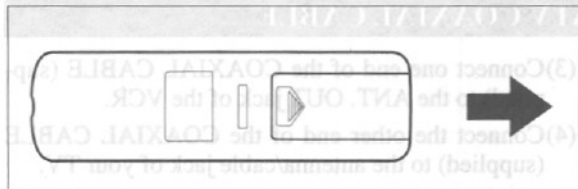

2

Insert 2 "AA" penlight batteries into the battery compartment in the direction indicated by the polarity (+/-) markings.

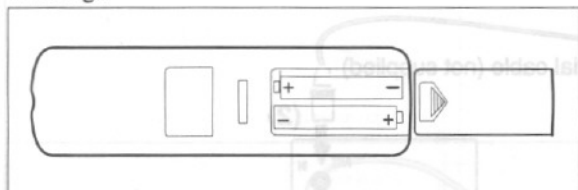

3

Replace the cover.

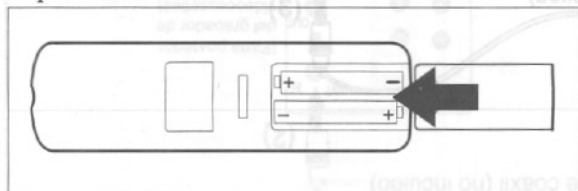

CABLE CONNECTIONS

For some of the most common types of connections, see the following drawings. Use only one connection. For any further complex connections, please contact your local dealer or other qualified persons. (You may need additional accessories which are not supplied).

COMBINATION VHF/UHF ANTENNA, CATV COAXIAL CABLE

- (1) Disconnect the round 75-ohm combination VHF/UHF coaxial antenna cable (or CATV coaxial cable) from the back of your TV set.
- (2) Reconnect the coaxial cable to ANT. IN terminal of the VCR.
- (3) Connect one end of the COAXIAL CABLE (supplied) to the ANT. OUT jack of the VCR.
- (4) Connect the other end of the COAXIAL CABLE (supplied) to the antenna/cable jack of your TV.

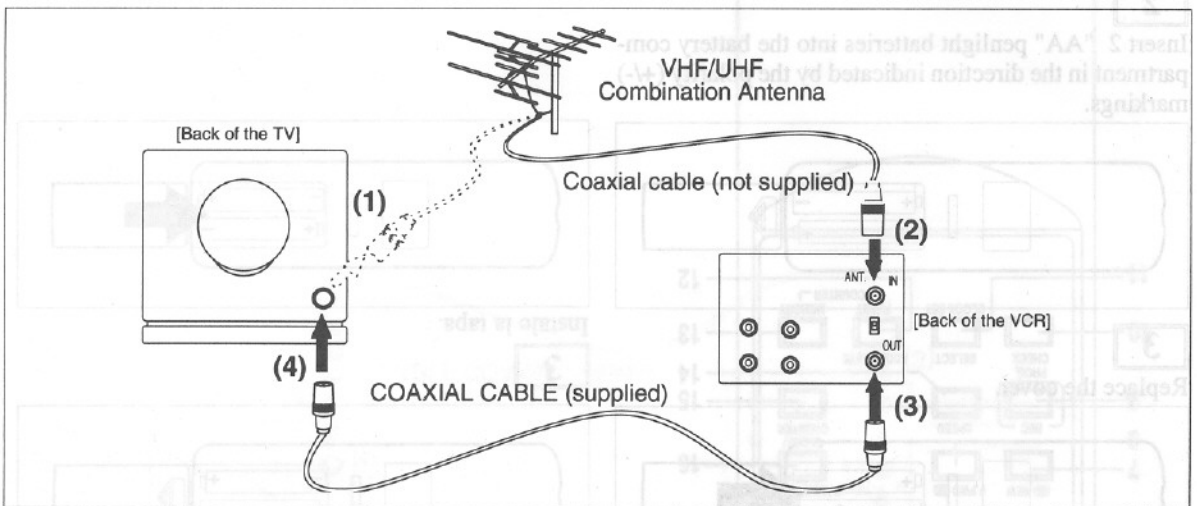

Note to CATV system installer

This reminder is provided to call the CATV system installer's attention to Article 820-40 of the NEC that provides guidelines for proper grounding and, in particular, specifies that the cable ground shall be connected to the grounding system of the building as close to the point of cable entry as practical.

SEPARATE VHF (75-OHM) / UHF (300-OHM) ANTENNA

- (1) Disconnect the VHF coaxial antenna cable and the UHF flat twin-lead antenna cable from the back of your TV set.
- (2) Reconnect those cables to a UHF/VHF combiner (not supplied).
- (3) Connect end of the UHF/VHF combiner to the ANT. IN terminal of the VCR.

- (4) Connect one end of the COAXIAL CABLE (supplied) to the ANT. OUT terminal of the VCR.
- (5) Connect the other end of the COAXIAL CABLE (supplied) to a UHF/VHF separator (not supplied).
- (6) Connect the separator's coaxial end to the TV's VHF jack, and flat twin-lead end to the TV's UHF terminal.

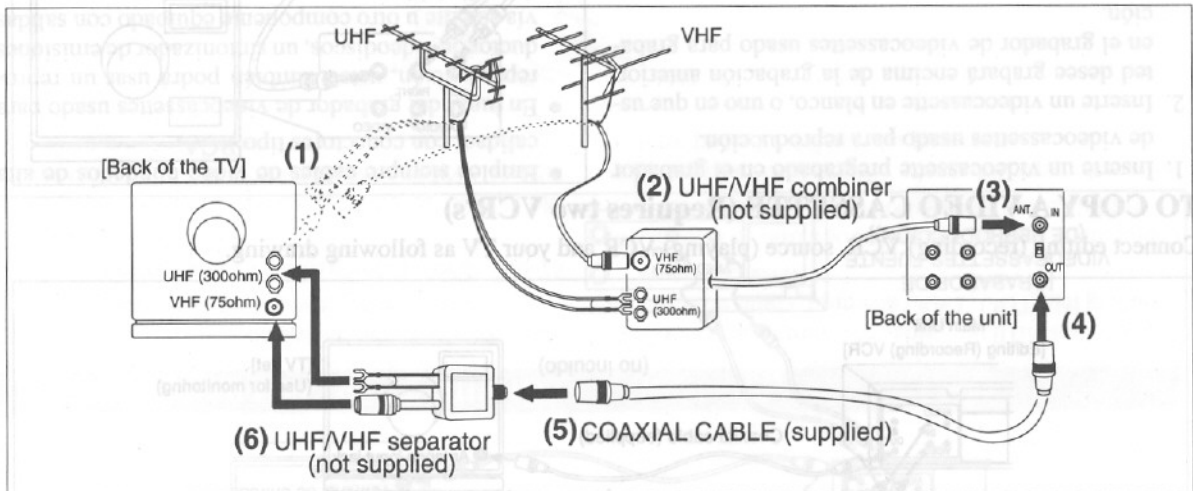

SEPARATE UHF/VHF (300-OHM) ANTENNA

- (1) Disconnect the UHF and VHF flat twin-lead antenna cable from the back of your TV set.
- (2) Reconnect those cables to a 300-75ohm combiner (not supplied).
- (3) Connect end of the 300-75ohm combiner to the ANT. IN terminal of the VCR.

- (4) Connect one end of the COAXIAL CABLE (supplied) to the ANT. OUT terminal of the VCR.
- (5) Connect the other end of the COAXIAL CABLE (supplied) to a 75-300ohm separator (not supplied).
- (6) Connect the separator's flat twin-lead ends to the TV's UHF and VHF terminals.

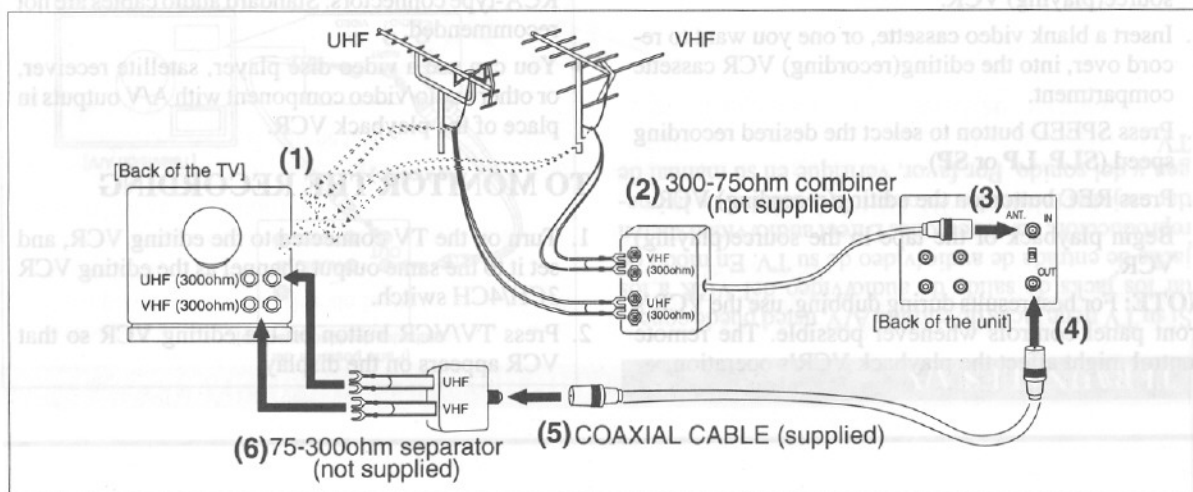

A/V TERMINALS

If your TV has A/V input jacks, you may connect your VCR's AUDIO/VIDEO OUTPUT jacks to the audio/video input jacks on back of your TV.

Direct audio/video connections usually result in a better picture and sound quality for tape playback. Please see your TV's owner's manual.

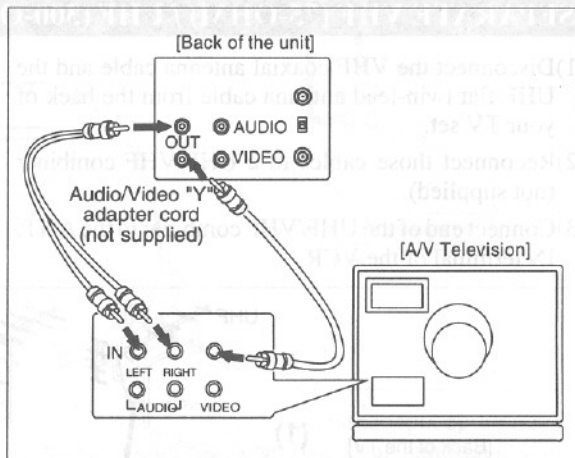

TO COPY A VIDEO CASSETTE (Requires two VCR's)

Connect editing (recording) VCR, source (playing) VCR and your TV as following drawing.

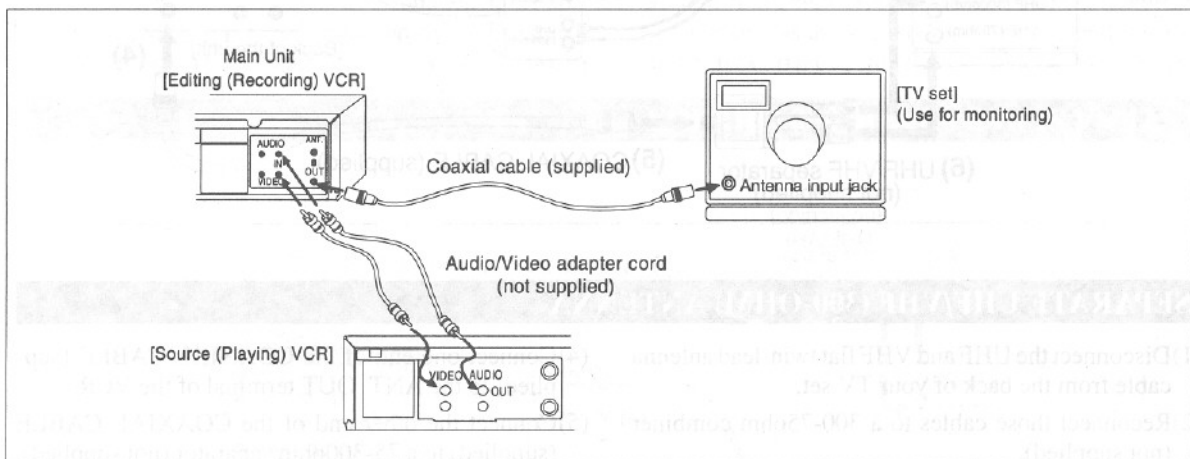

1. Insert a pre-recorded video cassette into the source(playing) VCR.
2. Insert a blank video cassette, or one you want to record over, into the editing(recording) VCR cassette compartment.
3. Press SPEED button to select the desired recording speed (SLP, LP or SP).
4. Press REC button on the editing(recording) VCR.
5. Begin playback of the tape in the source(playing) VCR.

NOTE: For best results during dubbing, use the VCR's front panel controls whenever possible. The remote control might affect the playback VCR's operation.

- Always use video-quality shielded cables with RCA-type connectors. Standard audio cables are not recommended.
- You can use a video disc player, satellite receiver, or other audio/video component with A/V outputs in place of the playback VCR.

TO MONITOR THE RECORDING

1. Turn on the TV connected to the editing VCR, and set it to the same output channel as the editing VCR 3CH/4CH switch.
2. Press TV/VCR button on the editing VCR so that VCR appears on the display.

USING A CATV CONVERTER BOX

If your cable service supplies you with a converter box, you can use the basic connection shown below.

TO RECORD AND VIEW A SCRAMBLED/UNSCRAMBLED CHANNEL.

1. Press TV/VCR button so that "VCR" appears on the display.
2. Set the TV channel to the same video output channel as the switch located on the back of the VCR (CH3 or 4).
3. Set the VCR channel selector to the output channel of the Cable Converter box.
4. Select the channel to be recorded at the Cable Converter Box.

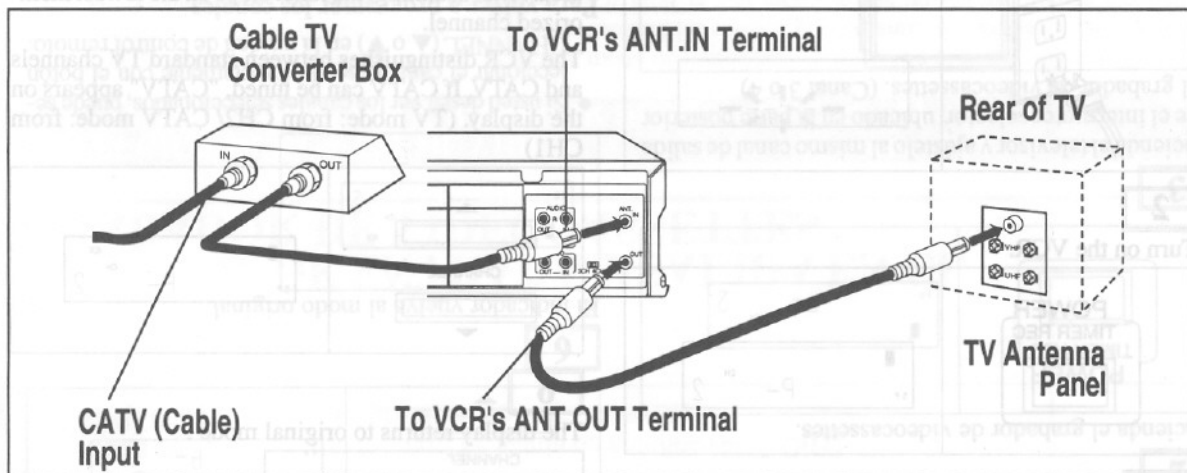

CONTROLLING VCR INPUT & OUTPUT

VIDEO OUTPUT CHANNEL SETTING (BACK OF VCR)

When the VCR is in the Playback mode, or when the TV/VCR button is in the VCR position, your TV will receive the signals from the VCR on either channel 3 or 4. Set the 3CH/4CH selector switch to the station that is not used for normal broadcasts in your area; then set your TV to that same channel when viewing from the VCR.

The RF converter output of this unit is set to VHF channel 3 prior to shipment from the factory.



INPUT SELECT

NOTE: When the AUDIO IN/VIDEO IN jacks are used, the VCR tuner is automatically disconnected. This means that you cannot preset channels or watch TV programs through the VCR's tuner.

Therefore, be sure to disconnect the cables from the VCR's AUDIO IN /VIDEO IN jacks when copying is completed.

CHANNEL MEMORY PROGRAMMING (Preset)

You can program the tuner to scan only the channels you receive in your area. See page 34 for channel designations.

- Programmed channels are erased when you disconnect the power cord or if a power failure occurs.
- In TV mode, the indicator will not display TV.

NOTE: WHEN YOU FIRST PLUG IN THE VCR POWER CORD AND THEN PRESS POWER BUTTON, THE VCR WILL INITIALLY BE IN THE PRESET MODE. IF YOU WANT TO PRESET AGAIN, SEE "To preset channel memory again" BELOW.

1

Plug the VCR power cord into a standard AC outlet. The display flashes --:--.

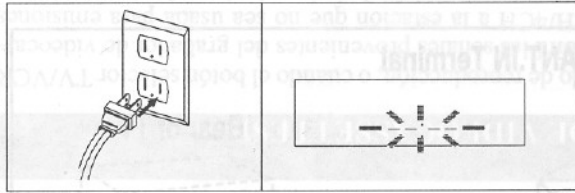

2

Turn on the VCR.

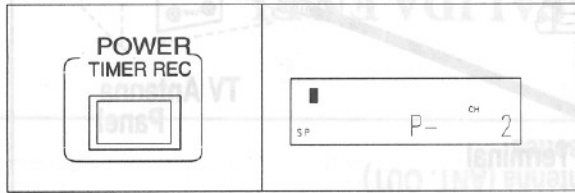

3

Turn on the TV and set the TV channel to the same video output channel located on the back of the VCR. (CH 3 or 4)



4

Press TV/VCR button so that "VCR" appears on the display.

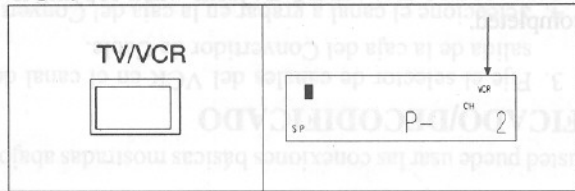

5

Press CHANNEL ▲ (or ▼) button once. The tuner scans and memorizes all the active channels in your area. After scanning, the tuner stops on the lowest memorized channel.

The VCR distinguishes between standard TV channels and CATV. If CATV can be tuned, "CATV" appears on the display. (TV mode: from CH2/ CATV mode: from CH1)

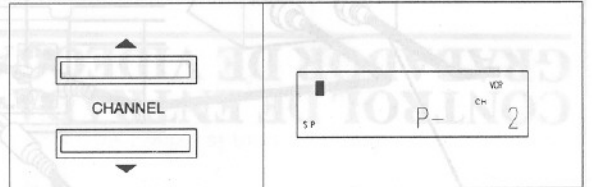

6

The display returns to original mode.

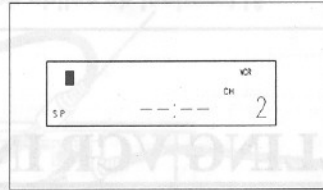

- If you want to recall the selected channels, you can select the desired channel directly by CHANNEL ▲ or ▼ button on the remote control unit.

To preset channel memory again

1. Turn on the VCR and the TV.
2. Set the TV channel to the same video output channel located on the back of the VCR.
3. Press TV/VCR button so that "VCR" appears on the display.
4. Press PRESET button on the remote control.
5. If you subscribe to cable TV, press TV/VCR button so that "CATV" appears on the display.
6. Press CHANNEL ▲ or ▼ button once. After scanning, the tuner stops on the lowest memorized channel.

TO CANCEL, ADD PRESET CHANNEL

Use this procedure to delete from memory the channels you no longer receive or seldom watch and to manually add to memory previously deleted channels.

CANCELLING PRESET CHANNELS

1

Press PRESET button.

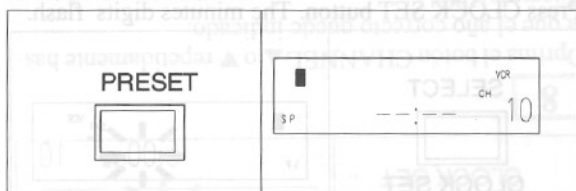

2

Enter the desired channel using the remote control number buttons. You must precede single-digit channel numbers with a zero (02, 03, 04 and so on).

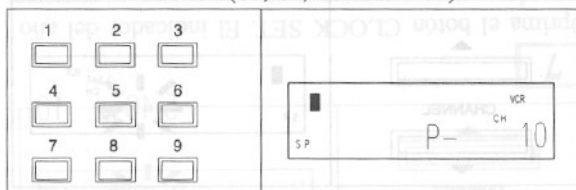

3

Press DELETE button. Channel number flashes.

For next channel you wish to cancel, select that channel and follow step [2].

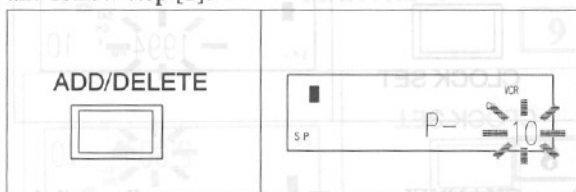

4

Press PRESET button. The channel number stops flashing.

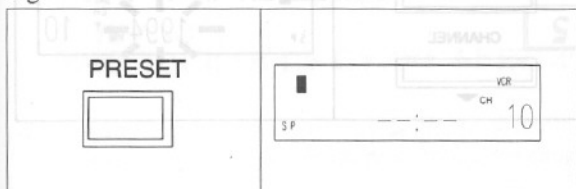

To check the channel(s) that has been cancelled, press CHANNEL ▲ or ▼ button. Now, CH 10 is cancelled.

ADDING PRESET CHANNELS

1

Press PRESET button.

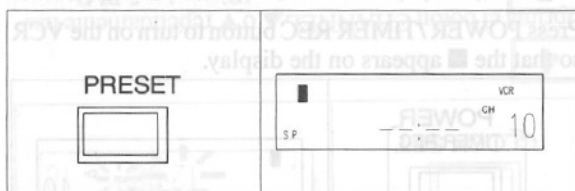

2

Enter the desired channel using the remote control number buttons. You must precede single-digit channel numbers with a zero (02, 03, 04 and so on).



3

Press ADD button. Channel number stops flashing. For next channel you wish to add select that channel and follow step [2].



4

Press PRESET button. The channel number is added to memory.

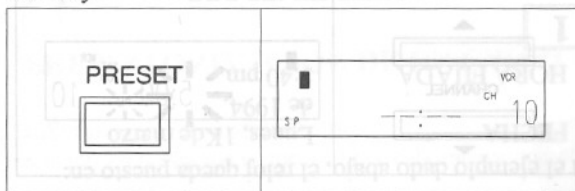

To check the channel(s) that has been added, press CHANNEL ▲ or ▼ button. Now, CH 10 is added.

SETTING THE CLOCK

Set the clock accurately for proper automatic timer recording. We suggest that you use a TV or radio station as your time source.

In the example below, the clock is to be set to:

DATE Tuesday 1st March, 1994
SETTING TIME 5:40PM.

1

Press POWER /TIMER REC button to turn on the VCR so that the ■ appears on the display.

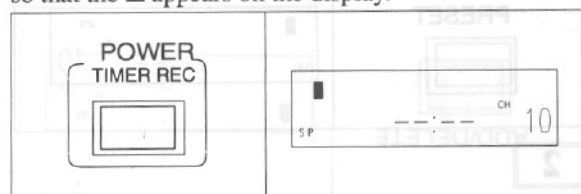

2

Press TV/VCR button on the remote control unit so that "VCR" appears on the display.

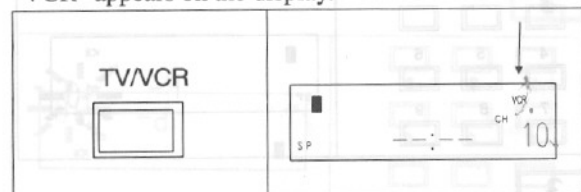

3

Press CLOCK SET button. The hours digits flash.

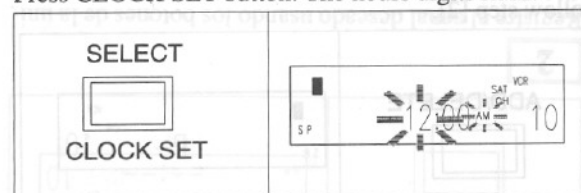

4

Press CHANNEL ▲ or ▼ button repeatedly until the correct hour is indicated. (Example: 5, PM)

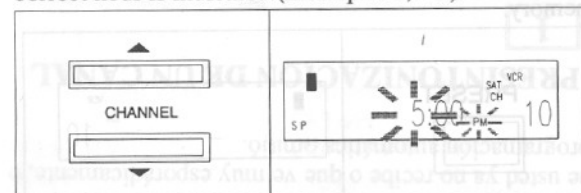

5

Press CLOCK SET button. The minutes digits flash.

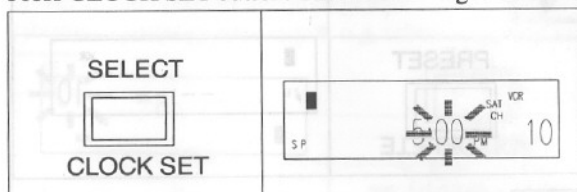

6

Press CHANNEL ▲ or ▼ button repeatedly until the correct minute is indicated. (Example: 40)

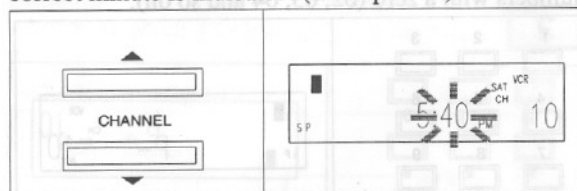

7

Press CLOCK SET button. The year digits flash.

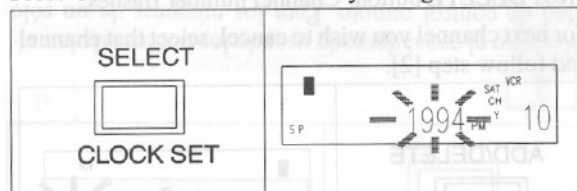

8

Press CHANNEL ▲ or ▼ button repeatedly until the correct year is indicated. (Example: 1994)

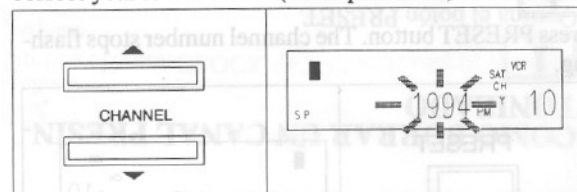

9

Press **CLOCK SET** button. The month digits flash.

SELECT

CLOCK SET

**10**

Press **CHANNEL ▲** or **▼** button repeatedly until the correct month is indicated. (Example: 03)

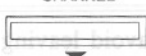
CHANNEL

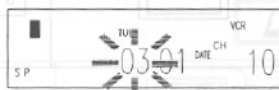
 CHANNEL

**11**

Press **CLOCK SET** button. The day digits flash.

SELECT

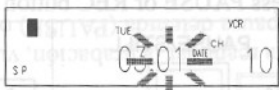
CLOCK SET

**12**

Press **CHANNEL ▲** or **▼** button repeatedly until the correct day is indicated. (Example: 01)

CHANNEL

 CHANNEL

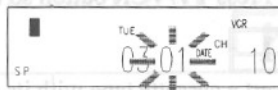
**13**

Press **CLOCK SET** button to start the clock. Although seconds are not displayed, they begin counting at 00 when you press **CLOCK SET** button.

SELECT

CLOCK SET

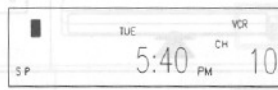
**NOTES:**

- When unplugging the AC-cord or if there is a power failure, "--:--" flashes on the display.
- If the display shows an abnormal reading or no reading, unplug the power cord for a few seconds. Then plug it back in.

VIEWING AND RECORDING THE SAME PROGRAM

- TV and VCR power must be on.
- Turn on the TV and set the TV channel to the same video output channel located on the back of the VCR. (CH 3 or 4)
- Press TV/VCR button so that "VCR" appears on the display.

1

Insert a cassette tape with its safety tab in place, if necessary, rewind or fast forward the tape to the point at which you want to begin recording.

Counter mode appears at counter 0:00:00 on the display.

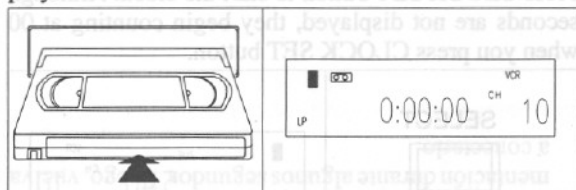

2

Select the program to be recorded by pressing the VCR number buttons or the CHANNEL ▲ or ▼ button.

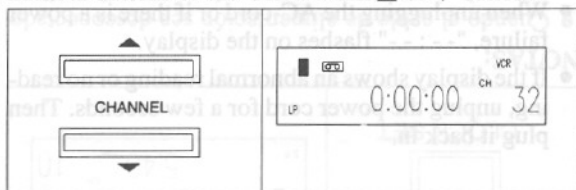

3

Press SPEED button to select the desired tape speed (SP-LP-SLP). (Example: LP)

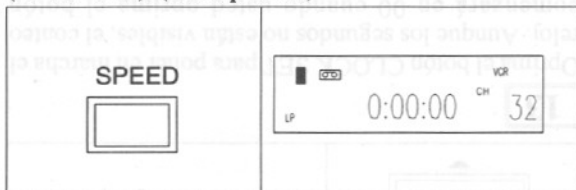

4

Press REC button.

The red "O" indicator lights on the display.

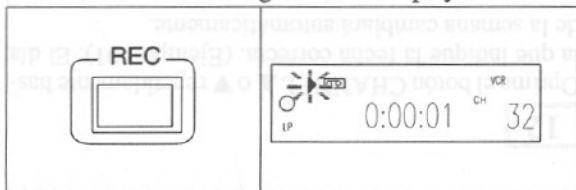

TO DELETE SCENES DURING RECORDING

5

Press PAUSE button.

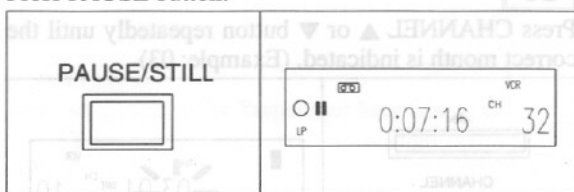

NOTE: To prevent tape damage, avoid leaving the VCR in the Pause mode for more than five minutes. After five minutes, the VCR will automatically return to the Record mode.

6

Press PAUSE or REC button to resume recording.

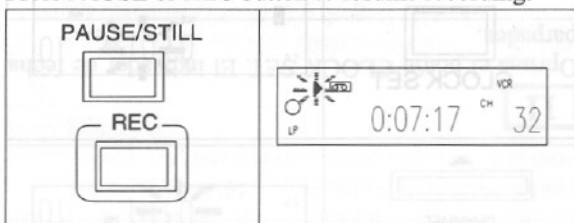

7

Press STOP button when recording is completed.

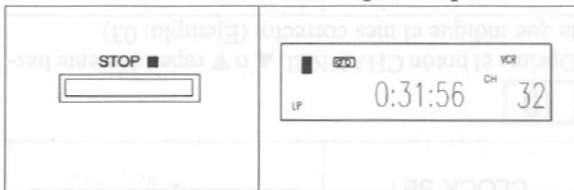

NOTE: You may not have good result when you record a TV game software etc.

RECORDING ONE PROGRAM WHILE VIEWING ANOTHER

You can record one program while viewing another. To start recording, follow steps [1] to [4] under "VIEWING AND RECORDING THE SAME PROGRAM" page 18.

5

Press TV/VCR button on the remote control unit to select TV so that "VCR" disappears from the display.

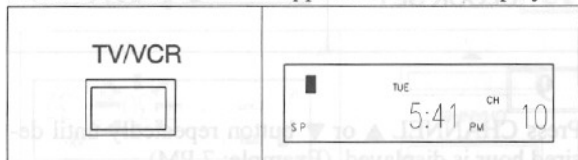

6

Set the TV to the channel you want to watch.



To monitor the progress of your recording,

7

Press TV/VCR button on the remote control unit so that "VCR" appears on the display.

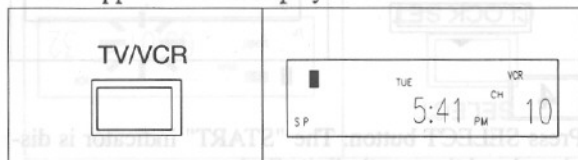

8

Turn on the TV and set the TV channel to the same output channel. (CH3 or 4)

AUTOMATIC TIMER RECORDING

You may set the VCR to start and end a recording while you are away. You can set seven events to record on specific days, daily or weekly within a 1 year period.

In the example below, the timer is being set to record:

Date Friday 6th May, 1994
Setting Time from 7:30PM to 8:30PM
Channel CH16
Tape Speed SLP

- VCR power must be turned on.
- Turn on the TV and set the TV channel to the same video output channel located on the back of the VCR. (CH 3 or 4)
- Press TV/VCR button so that "VCR" appears on the display.
- Clock must be set to the correct time and date before setting the timer.

1

Insert a cassette tape with its safety tab in place, if necessary, rewind or fast forward the tape to the point at which you want to begin recording.

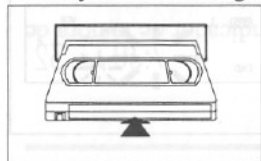

2

Press PROG. CHECK button.

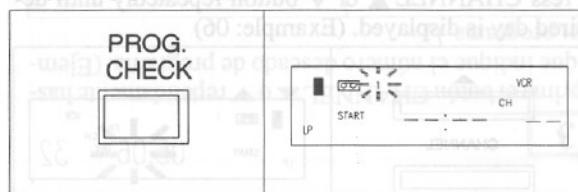

3

Press CHANNEL ▲ or ▼ button repeatedly until desired program number is displayed.

(Example: program 1)

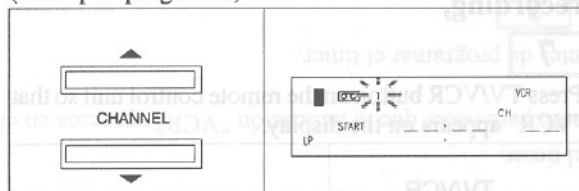
**4**

Press SELECT button. The "START" indicator is displayed and the month digits flash.

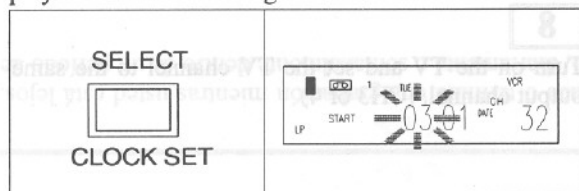
**5**

Press CHANNEL ▲ or ▼ button repeatedly until desired month is displayed. (Example: 05)

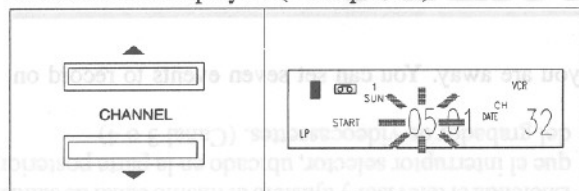
**6**

Press SELECT button. The day digits flash.

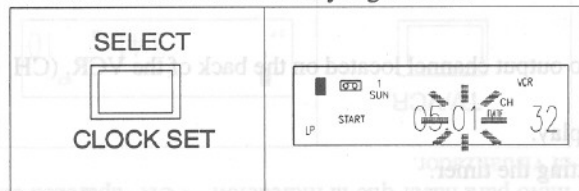
**7**

Press CHANNEL ▲ or ▼ button repeatedly until desired day is displayed. (Example: 06)

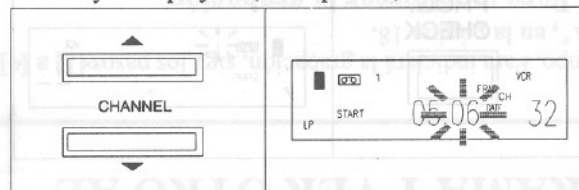
**8**

Press SELECT button. The START hours digits flash.

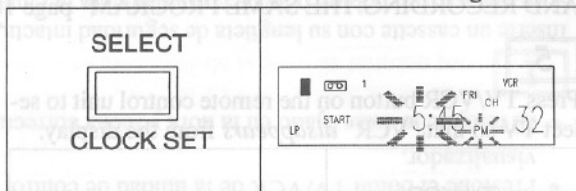
**9**

Press CHANNEL ▲ or ▼ button repeatedly until desired hour is displayed. (Example: 7,PM)

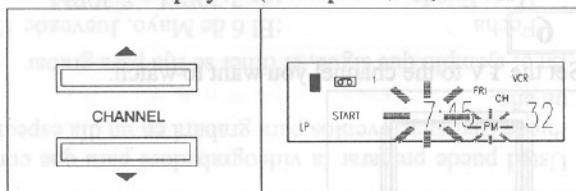
**10**

Press SELECT button. The START minutes digits flash.

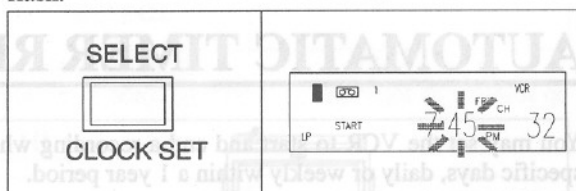
**11**

Press CHANNEL ▲ or ▼ button repeatedly until desired minute is displayed. (Example: 30)

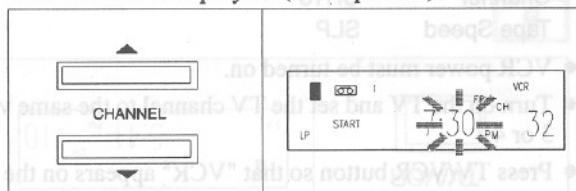
**12**

Press SELECT button. The "END" indicator is displayed and END hour digits flash.

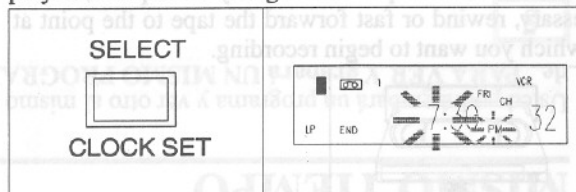

13

Press CHANNEL ▲ or ▼ button repeatedly until desired hour is displayed. (Example: 8,PM)

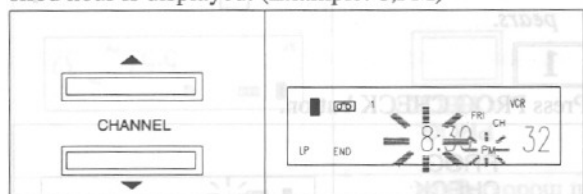
**14**

Press SELECT button. The END minutes digits flash.

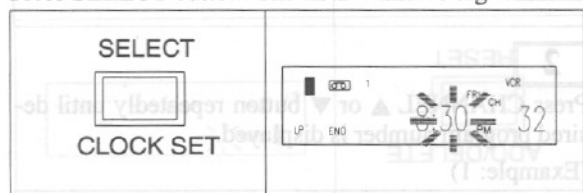
**15**

Press CHANNEL ▲ or ▼ button repeatedly until desired minute is displayed. (Example: 30)

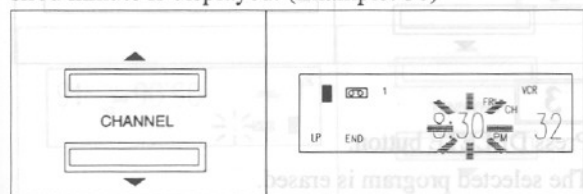
**16**

Press SELECT button. The channel digits flash.

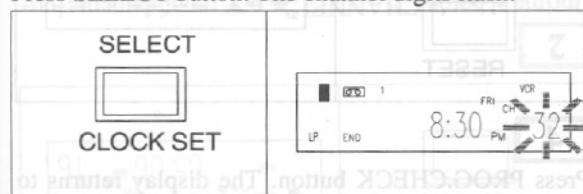
**17**

Press CHANNEL ▲ or ▼ button repeatedly until desired channel is displayed. (Example: CH 16)

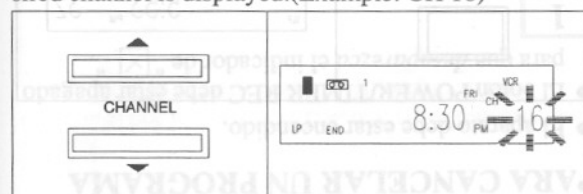
**18**

Press SELECT button. The tape speed indicator flashes.

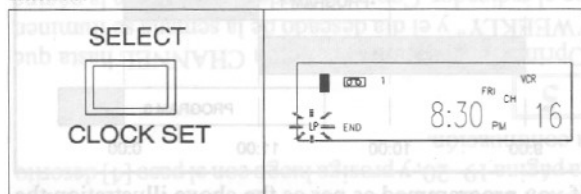
**19**

Press CHANNEL ▲ or ▼ button repeatedly until desired tape speed is displayed.

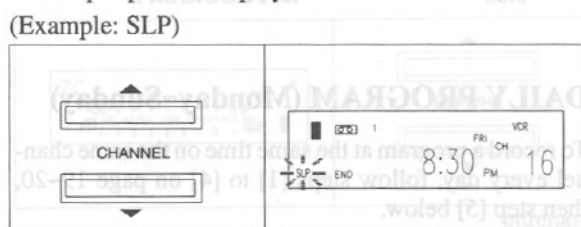
**20**

Press PROG.CHECK button. The program number flashes.

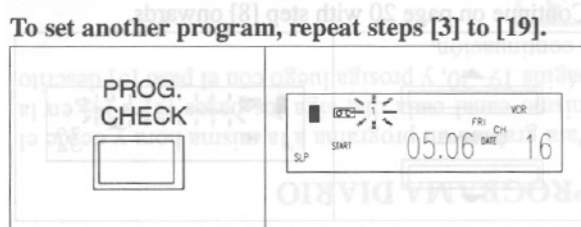
**21**

Press POWER /TIMER REC button to set automatic timer recording. The "☒" indicator lights up on the display. The number of all programmed events are displayed with current time.

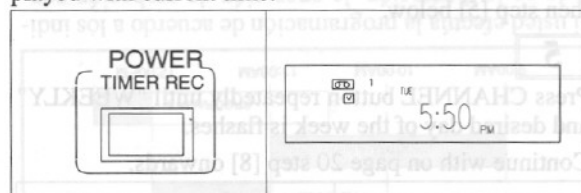

When the programs overlap, the earlier program has priority.

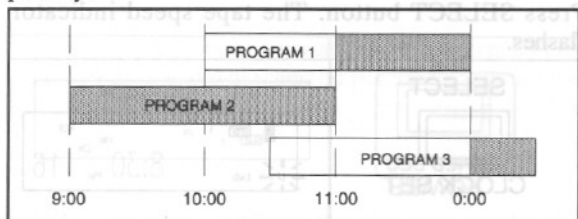

If you programmed as per as the above illustration the timer recording would be carried out as follows:

9:00 - 11:00 for PROGRAM 2
 11:00 - 0:00 for PROGRAM 1
 0:00 - for PROGRAM 3

DAILY PROGRAM (Monday~Sunday)

To record a program at the same time on the same channel every day, follow steps [1] to [4] on page 19~20, then step [5] below.

5

Press CHANNEL ▲ or ▼ button repeatedly until all of the day indicators flash together.

Continue on page 20 with step [8] onwards.

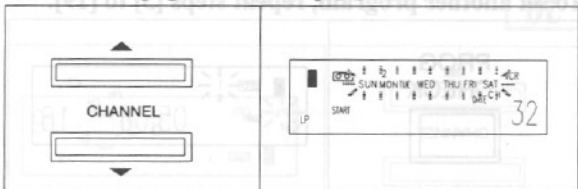

WEEKLY PROGRAM

To record a program at the same time on the same channel every week, follow steps [1] to [4] on page 19~20, then step [5] below.

5

Press CHANNEL button repeatedly until "WEEKLY" and desired day of the week is flashes.

Continue with on page 20 step [8] onwards.

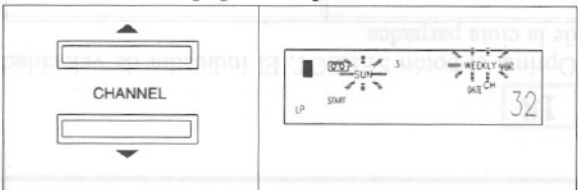

TO CANCEL A PROGRAM

- VCR power must be turned ON. Press POWER TIMER REC so that the "☒" indicator disappears.

1

Press PROG.CHECK button.

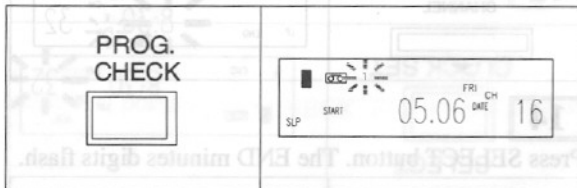

2

Press CHANNEL ▲ or ▼ button repeatedly until desired program number is displayed.

(Example: 1)

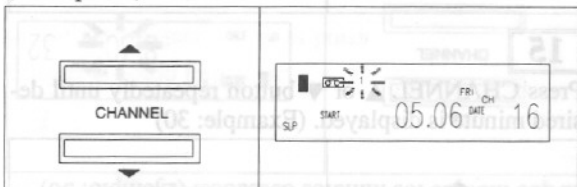

3

Press DELETE button.

The selected program is erased.

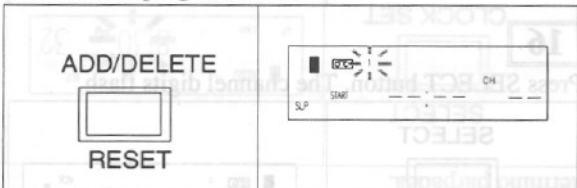

4

Press PROG.CHECK button. The display returns to original mode.

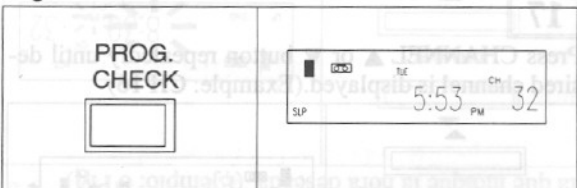

TO CHECK THE START/END TIME

After setting the timer, you can check the program number, Start/End time and channel number.

1

Press PROG.CHECK button.

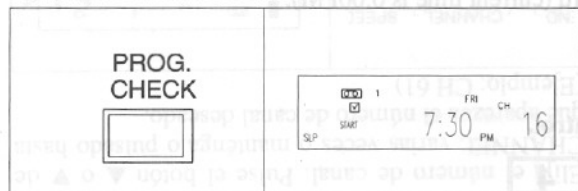

2

Press CHANNEL ▲ or ▼ button repeatedly until desired program number is displayed.

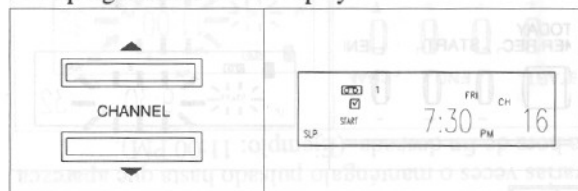

3

Press SELECT button repeatedly.

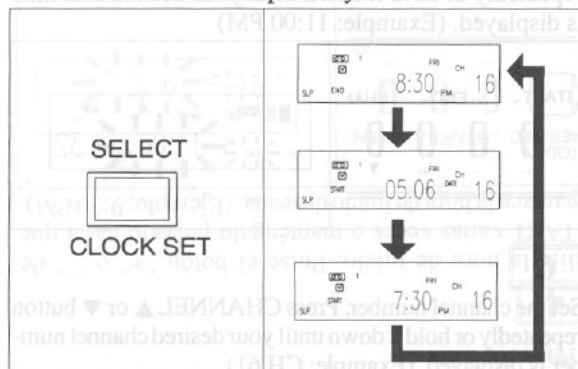

Repeat step [2] and [3] for next program number.

4

Press PROG.CHECK button to return to current timer display.

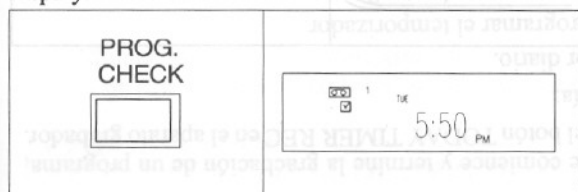

TO STOP RECORDING

Press STOP button on the VCR.

NOTE: STOP button on the remote control unit will not function in the Automatic Timer Recording mode.

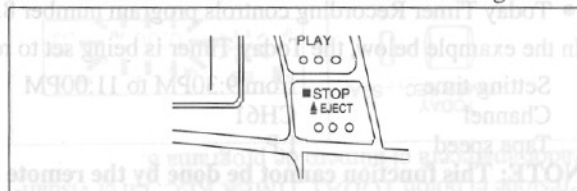

AUTOMATIC TIMER RECORDING HINTS

- If there is a power failure or the VCR is unplugged for more than a few seconds, the clock setting and all timer settings are lost.
- If the tape runs out before the end time, the VCR will switch to the Stop mode immediately, eject the tape and the VCR power will be turned off. The "☑" indicator will flash.
- If a tape is not inserted or the erase-protection tab is removed, the "☑" indicator flashes and automatic timer recording cannot occur. Insert a tape that allows recording.

TODAY TIMER RECORDING

You may set the VCR to start and end recording one program within 24 hours by simply pressing TODAY TIMER REC button on the VCR. It is easy for you to set the timer for recording today's TV program.

- VCR power must be on to set Today Timer.
- Clock must be set to the correct time before setting the timer.
- Today Timer Recording controls program number 8.

In the example below, the Today Timer is being set to record (current time is 6:00PM):

Setting time	from 9:30PM to 11:00PM
Channel	CH61
Tape speed	LP

NOTE: This function cannot be done by the remote control.

1

Insert a cassette tape with its safety tab in place. (If necessary, rewind or fast forward the tape to the point at which you want to begin recording.)

The display will be changed to Counter mode at counter 0:00:00.

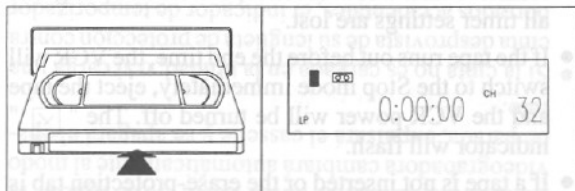

2

Press TV/VCR button so that "VCR" appears on the display.

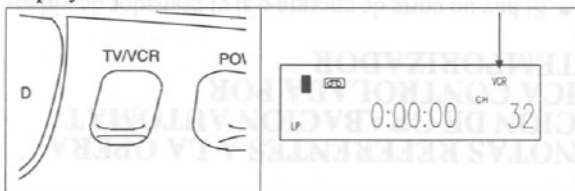

3

Press TODAY TIMER REC button on the VCR. Program number "8" appears on the display.

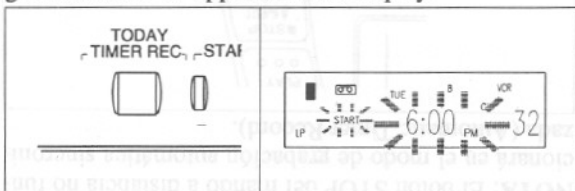

4

Set the desired start time. Press START "+" or "-" button repeatedly or hold it down until your desired start time is displayed. (Example: 9:30 PM)

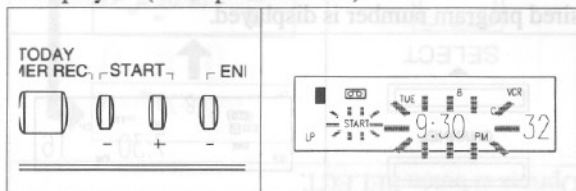

5

Set the desired end time. Press END "+" or "-" button repeatedly or hold it down until your desired end time is displayed. (Example: 11:00 PM)

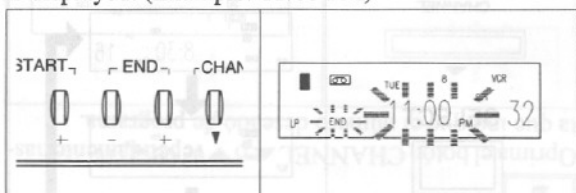

6

Set the channel number. Press CHANNEL ▲ or ▼ button repeatedly or hold it down until your desired channel number is displayed. (Example: CH 61)

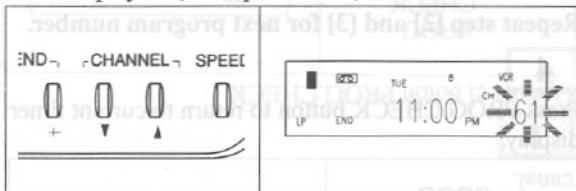

7

Set the tape speed. Press SPEED button until your desired tape speed is displayed. (Example: LP)

The tape speed can be changed at any step from [3] to [6].

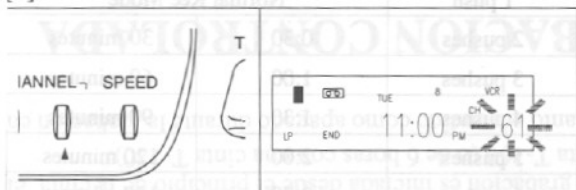

8

Press TODAY TIMER REC button to return to original mode.



9

Press POWER/TIMER REC button to set Today Timer Recording. This turns the VCR power off. And the "✓" indicator lights up on the display. The program number "8" is displayed with current time.

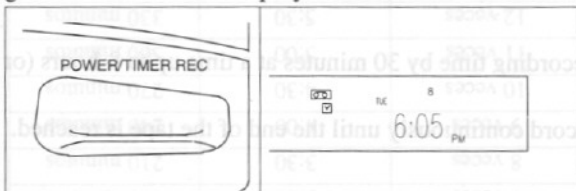

When the programs overlap, Today Timer Recording program has priority.

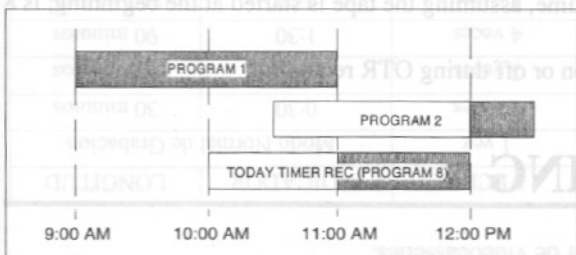

If you program as per the illustration the timer recording would be carried out as follows.

- 9:00AM - 11:00AM for PROGRAM 1
- 11:00AM - 12:00AM for PROGRAM 8 (TODAY TIMER REC)
- 12:00AM - for PROGRAM 2

TO CHECK THE START/END TIME

To check the start/end time and channel number, first press POWER/TIMER REC button so that "✓" indicator appears, then press TODAY TIMER REC button once. Both the start and end time will appear for 3 seconds each, and return to the Timer Stand-by mode.

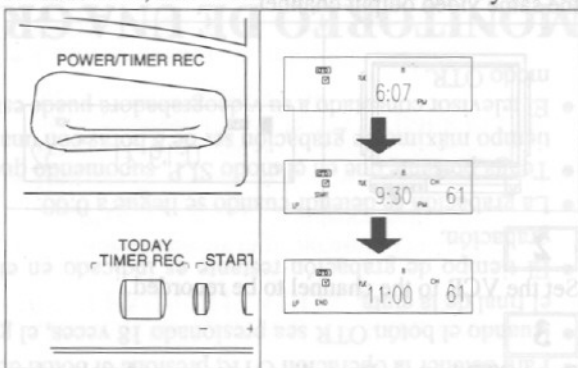

TO CANCEL A TODAY TIMER PROGRAM

- While setting a program; press STOP/EJECT button on the VCR.
- After setting a program; (power must be on) First, press TODAY TIMER REC button. Then, press STOP/EJECT button.
- While recording is in progress; press STOP/EJECT button.

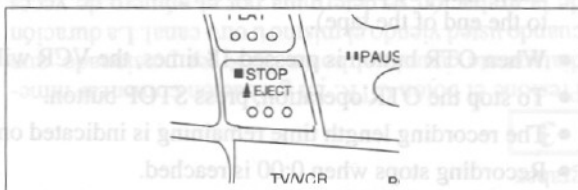

OTR (ONE TOUCH RECORDING)

The One Touch Recording function enables you to record a program simply by pressing OTR button on the VCR. According to the table, simply press OTR button as many times as needed to set the desired recording length. The channel number to be recorded and recording length will be shown on the display.

1

Turn on the VCR and TV. And set the TV channel to the same video output channel.

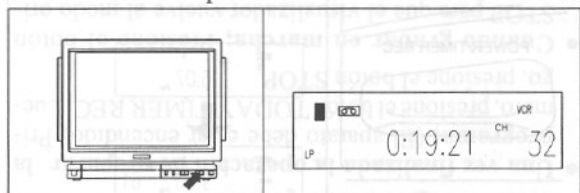

2

Set the VCR to the channel to be recorded.

3

Press OTR button. Recording starts immediately when the OTR button is pressed, whether if you are watching the same or a different channel. The recording length will be determined by the number of times you press OTR button.

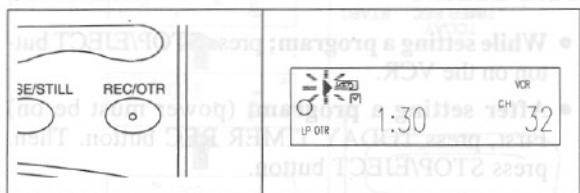

- Each time you press OTR button, you will extend the recording time by 30 minutes at a time up to 8-hours (or to the end of the tape).
- When OTR button is pressed 18 times, the VCR will record continuously until the end of the tape is reached.
- To stop the OTR operation, press STOP button.
- The recording length time remaining is indicated on the display as the recording is started.
- Recording stops when 0:00 is reached.
- Please note that in the SLP mode maximum recording time, assuming the tape is started at the beginning, is 8 hours using T-160 (or 6 hours using T-120).
- The TV that is connected to your VCR may be turned on or off during OTR recording.

PUSH(ES)	DISPLAY	LENGTH
1 push	Normal Rec Mode	
2 pushes	0:30	30 minutes
3 pushes	1:00	60 minutes
4 pushes	1:30	90 minutes
5 pushes	2:00	120 minutes
6 pushes	2:30	150 minutes
7 pushes	3:00	180 minutes
8 pushes	3:30	210 minutes
9 pushes	4:00	240 minutes
10 pushes	4:30	270 minutes
11 pushes	5:00	300 minutes
12 pushes	5:30	330 minutes
13 pushes	6:00	360 minutes
14 pushes	6:30	390 minutes
15 pushes	7:00	420 minutes
16 pushes	7:30	450 minutes
17 pushes	8:00	480 minutes
18 pushes	Normal Rec Mode	

MONITORING RECORDING

1

Turn on the TV and set the TV channel to the same VCR video output channel located on the back of the VCR. (CH3 or 4).

2

Press TV/VCR button on remote control unit so that "VCR" appears on the display.

NOTE: The VCR will continue recording until the pre-set end time is reached or the tape runs out.

VIEWING ONLY TV (WITHOUT RECORDING)

- The VCR must be plugged into an AC outlet.

1

Turn VCR power off or press TV/VCR button to select TV, so that "VCR" disappears from the display.

2

Turn on the TV and select the channel you want to watch.

For viewing only TV, the VCR may be turned on or off, once "VCR" has been removed from the display.

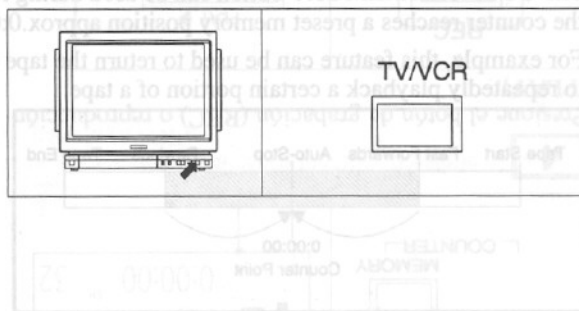

PLAYBACK

1

Turn on the TV and set the TV channel to the same video output channel.



2

Insert a tape. VCR will automatically turn on. Press PLAY button.

(If the erase-protection tab has been removed, the VCR will start playback automatically.)

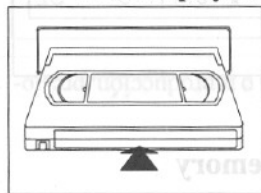

3a

If a tape is already in the VCR, press **PLAY button on the VCR**. Power will turn on and playback will start automatically.

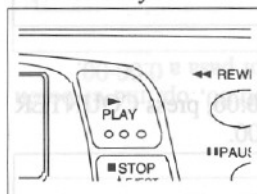

3b

If a tape is already in the VCR, Press **POWER button to turn on**, and then press **PLAY button on the remote control**.

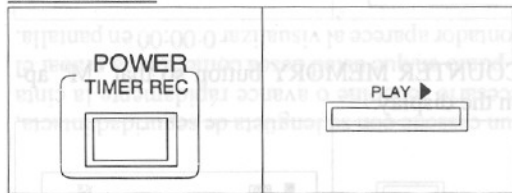

4

Press STOP button when playback is completed.

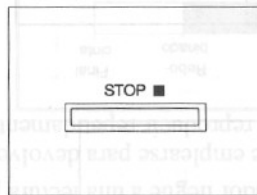

COUNTER MEMORY

The COUNTER MEMORY button can be used during rewind or fast forward to automatically stop the tape when the counter reaches a preset memory position approx. 0:00:00 reading.

For example, this feature can be used to return the tape to a pre-selected position immediately after recording, or to repeatedly playback a certain portion of a tape.

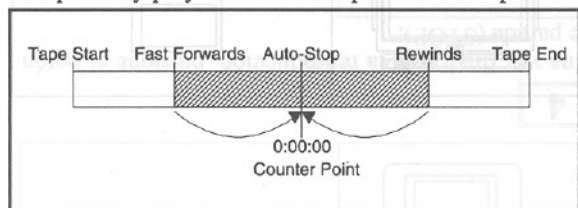

1

Insert a cassette tape with its safety tab in place, if necessary, rewind or fast forward the tape to the point at which you want to begin recording.

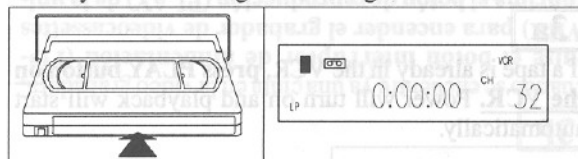

2

If the counter is not shown 0:00:00, press COUNTER RESET button to reset to 0:00:00.

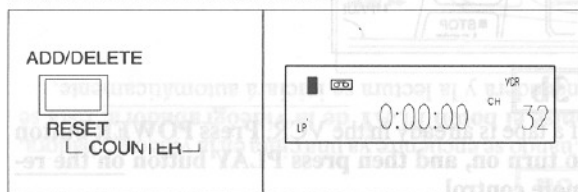

3

Press COUNTER MEMORY button so that "M" appears on the display.

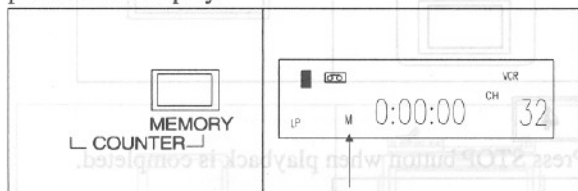

4

Press REC or PLAY button.

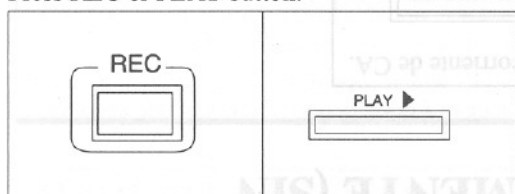

5

Press STOP button when recording or playback is completed.

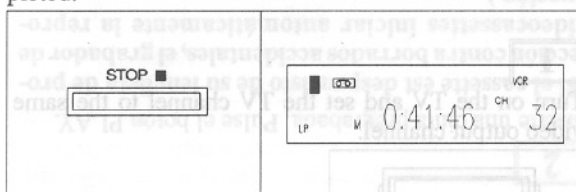

6

(If the counter is not displayed, press CLOCK/COUNTER button so that the counter appears on the display.) To activate the counter memory function, press REW button. The tape will automatically stop when the counter returns to 0:00:00.

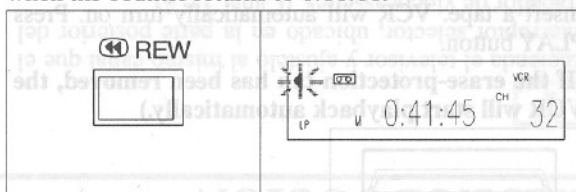

To cancel the counter memory

When the counter appears on the display, press COUNTER MEMORY button so that "M" disappears from the display.

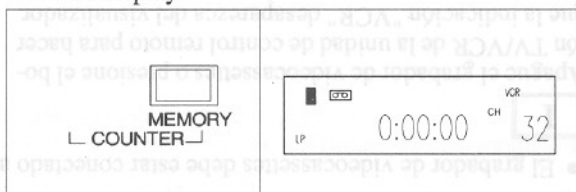

SPECIAL FEATURES

Picture Search(SP/LP/SLP Mode)

You may view a video tape at a high speed in either a forward or reverse direction. This feature is useful in finding or skipping over a particular scene on a tape. In this mode, the sound will be muted.

Forward Direction:

When in the Play mode, press F.FWD button to view the tape at a fast speed in the forward direction.

Reverse Direction:

To view the tape at a fast speed in the reverse direction, press REW button in the Play mode.

For normal speed, simply press PLAY button.

Super High Speed Search (LP/SLP Mode)

For Picture Search in super high speed:

- 1) Press either F.FWD or REW button while the unit is in the Play mode.
- 2) Release button.
- 3) Depress it again. The unit will now search in super high speed.

For normal playback simply press PLAY button.

Vertical Hold Control

When the picture begins to vibrate vertically, adjust to stabilize the picture by pressing CHANNEL ▲ or ▼ button.

NOTES:

- This adjustment works only in the Still mode with CHANNEL ▲ or ▼ button.
- When the picture is distorted or rolling vertically, adjust vertical hold control on your TV.
- Some newer TV's do not have a user adjustable vertical hold control.

Still Picture During Playback

If you press PAUSE button during playback, the picture will "freeze" on the screen. You may use this feature to study details of a particular scene. Press PLAY button to continue playback.

NOTE: The VCR will automatically switch to the Stop mode, if it is left in the Pause mode for more than five minutes.

Noise Cancelling

If you use the PAUSE button to freeze the picture during playback with tapes recorded in SLP mode, usually there will be video "noise" lines on the screen. This is normal, however, this VCR has a special feature that allows you to reposition or reduce the lines. Each time you press PAUSE button the lines will change position on the screen. This enables you to see the picture in its entirety without distracting noise lines.

If the tape was originally recorded in SP or LP mode, the still picture will, in addition to the "noise" lines, be black and white.

THIS IS NOT A FAULT OF THE MACHINE BUT MERELY A BY-PRODUCT OF THE TECHNOLOGY INVOLVED IN PRODUCING A VCR WITH A LONG-PLAY MODE.

Tracking Adjustment

- Tracking adjustment will be set automatically (Digital TRacking function) when you start playback. "DTR" appears on the display.
- When playing pre-recorded tapes or tapes recorded on units other than your own, noise lines (black and white streaks) may appear on the playback picture. If this occurs, adjust the tracking control by pressing CHANNEL ▲ or ▼ button until the streaks disappear. To return to the DTR function, stop the tape once and start playback again.
- To set center position, press both CHANNEL ▲ or ▼ button at the same time.

NOTE: This function is controlled only by the buttons on the VCR. The buttons on the remote control will no adjust tracking.

Auto Rewind

When the end of a tape is reached during recording, playback, or fast-forward, the tape will automatically rewind to the beginning (or to the 0:00:00 counter reading if the memory function is activated), eject, and the VCR will turn off.

NOTES:

- The tape will not auto-rewind during timer recording or One Touch Recording.
- When the tape is rewound to the preset memory position, the tape will not eject and the VCR will not turn off.

VIDEO CASSETTE TAPE

This VCR will operate with any cassette that has the VHS mark. For best results we recommend the use of high-quality tapes.

- Do not use poor quality or damaged tapes.

The table below shows the recording/playback time using T-60, T-120 or T-160 tapes in the SP, LP or SLP mode.

MODE	CASSETTE		
	T-60	T-120	T-160
SP Mode	1 hour	2 hours	2-2/3 hours
LP Mode	2 hours	4 hours	5-1/3 hours
SLP Mode	3 hours	6 hours	8 hours

When handling video tapes, follow the precautions below:

- Avoid moisture, which can condense on the tape if it is moved from a cold place to a warm place. Playing a tape that has moisture in it will damage the tape and your VCR. Before using a tape with these conditions, wait until the tape has warmed to room temperature and the moisture has evaporated.
- Avoid extreme heat, high humidity and magnetic fields.
- Do not tamper with the cassette mechanism.
- Do not touch the tape with your fingers.

ERASE PREVENTION

You may prevent accidental erasing of a tape by breaking off the tab on the back edge of the cassette. If you decide to record on the tape again, cover the hole with plastic tape.

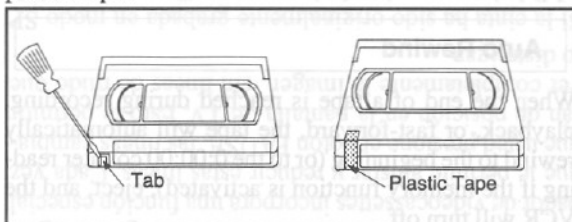

INSERTING A CASSETTE

Insert the cassette in the direction as shown. Push in gently, but continuously, on the center-back of the cassette until it is drawn into the VCR.

VCR is automatically turned on, and cassette-in indicator will light when the cassette is properly inserted.

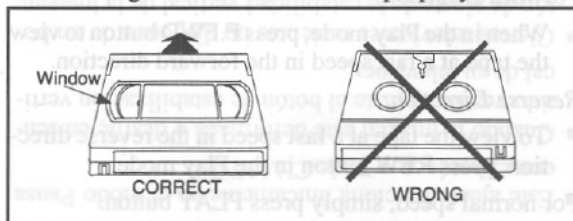

REMOVING A CASSETTE

1

Press EJECT button on the unit or on the remote control.



2

When the cassette-in indicator goes off and the cassette stops moving, pull the cassette out of the cassette compartment and store it properly.

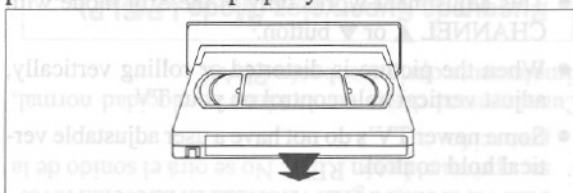

3

Store the cassette in its case as shown.

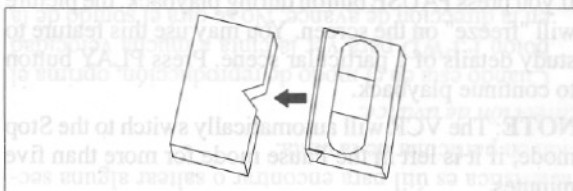

If you have followed the instructions contained in this manual and have difficulty in operating your VCR, locate the SYMPTOM in the left column below. Check the corresponding POSSIBLE CAUSE and CORRECTIVE ACTION columns to remedy the problem.

SYMPTOM	POSSIBLE CAUSE	CORRECTIVE ACTION
No power.	<ul style="list-style-type: none"> Power cord is not connected. POWER button is set to off position. 	<ul style="list-style-type: none"> Connect power cord to AC outlet. Set the POWER button to on position.
Timer recording is not possible.	<ul style="list-style-type: none"> The timer recording is set incorrectly. The timer recording is not set to on position. VCR clock is not set correctly. 	<ul style="list-style-type: none"> Set the timer recording correctly. Set TIMER REC to on position. Set VCR clock correctly.
Rec mode cannot be engaged.	<ul style="list-style-type: none"> The record safety tab on cassette is missing. 	<ul style="list-style-type: none"> Place vinyl tape over missing safety tab.
No picture or poor picture on playback.	<ul style="list-style-type: none"> The TV channel selector is not set to the proper channel. The TV fine tuning is not set correctly. 	<ul style="list-style-type: none"> On playback, set the TV to channel 3 or 4 for video output channel. Fine tune your TV.
Noise in picture on playback.	<ul style="list-style-type: none"> Video heads are dirty. 	<ul style="list-style-type: none"> Head cleaning is necessary, consult the nearest Funai Authorized Service Center.
No picture on TV.	<ul style="list-style-type: none"> The VCR is in TV mode. 	<ul style="list-style-type: none"> Press TV/VCR button.
Playback picture is partially noisy.	<ul style="list-style-type: none"> The TRACKING control is not set correctly. 	<ul style="list-style-type: none"> Adjust TRACKING control for a better picture.
On-the-air TV programs cannot be seen.	<ul style="list-style-type: none"> Connections are not correctly made. 	<ul style="list-style-type: none"> Re-check the ANT. IN and ANT. OUT connections.
No operation by infrared Remote Control.	<ul style="list-style-type: none"> Weak batteries. 	<ul style="list-style-type: none"> Check the batteries in Infrared Remote Control.

SERVICIO

LIMPIEZA DE LAS CINTAS

LIMPIEZA DEL CARRILLE

CABINET CLEANING

- Wipe the front panel and other exterior surfaces of the VCR with a soft cloth immersed in lukewarm water and wrung dry.
- Never use a solvent or alcohol. Do not spray insecticide liquid near the VCR. Such chemicals may cause damage and discoloration to the exposed surfaces.

HEAD CLEANING

- Picture playback may become blurred or interrupted while the TV program received is clear. This does not mean that the recorded program has been erased. Dirt accumulated on the heads after long periods of use, or usage of rental or old tapes can cause this problem. In this case, head cleaning requires highly technical attention, therefore consult the nearest Funai Authorized Service Center. Clean heads only when problems occur.

SERVICING

- Should your VCR become inoperative, do not try to correct the problem by yourself. There are no user-serviceable parts inside. Turn off, unplug the power cord, and take the unit to Funai Authorized Service Center for servicing.

SINTOMA	CAUSA PROBABLE	MEDIDA CORRECTIVA
La unidad no se enciende.	• El cable de alimentación no ha sido conectado. • El interruptor de alimentación (POWER) está desactivado (OFF).	• Conecte el cable de alimentación a un tomacorriente de C.A. • Active (ON) el interruptor de alimentación (POWER).
La operación de grabación controlada por temporizador no puede ser efectuada.	• La función de grabación controlada por temporizador no ha sido programada en forma incorrecta. • El temporizador ha sido programado en forma incorrecta.	• Programe correctamente el temporizador (REC). • Active (ON) el botón de grabación controlada por temporizador (TIMER REC).
La unidad no puede ser puesta en modo de grabación.	• El cassette está desprovisto de su lengüeta de protección contra borrados accidentales. • o ausencia de magnetismo durante la grabación.	• Cubra la abertura de la lengüeta con cinta adhesiva.
Avanzada de imagen.	• La función de sintonización fue delimitada.	• El selector de canales del receptor no ha sido ajustado al canal de salida correcto.
No operación por intrínseco Remote Control.	• Las baterías han sido agotadas en forma incorrecta.	• Cambie las baterías con precisión en la forma indicada.
Queda en TV programando parcialmente ruido.	• Conexiones a tierra no correctamente hechas.	• Re-check the GROUND IN and ANT. OUTLINE connections.
Playback picture is partially noisy.	• The TRACKING control is not set correctly.	• Adjust TRACKING control for a better picture.
No picture on TV.	• The VCR is in TV mode.	• Press TV/VCR button.
When in picture on playback.	• Video heads are dirty.	• Head cleaning is necessary. Consult the nearest Funai Authorized Service Center.
Picture is blurred.	• The VCR is in TV mode.	• Fine tune your TV.
Picture is not set to correct position.	• The VCR is in TV mode.	• On playback, set the TV to channel 3 or 4 for video output channel.
Picture is not set to correct position.	• The VCR is in TV mode.	• Place video tape over missing cable tap.
Picture is not set to correct position.	• The VCR is in TV mode.	• Set VCR clock correctly.
Picture is not set to correct position.	• The VCR is in TV mode.	• Set the timer recording correctly.

Si a pesar de haber seguido las instrucciones de este manual, usted tiene dificultades en operar su grabador de video-cassettes, localice el SINTOMA en la columna izquierda de la tabla que presentamos a continuación. Para determinar el problema, verifique las columnas CAUSA PROBABLE y MEDIDA CORRECTIVA correspondientes.

SPECIFICATIONS

GENERAL SPECIFICATIONS

Television system	: NTSC, TV standard
Video heads	: Rotary two-head
Tape width	: 1/2inch (12.65mm)
Tape speed	
SP	: 33.35mm/sec.
LP	: 16.67mm/sec.
SLP	: 11.12mm/sec.
Tuner channel	
VHF	: #2~#13
UHF	: #14~#69

Cable channel	: 5A, A-5 ~ A-1, A ~ W+84
RF converter	: Built-in VHF converter
Converter output	: VHF Channel 3 or 4.
Timer indication	: AM/PM 12-hour system
Operating temperature	: 5°C~40°C (41°F~104°F)

Terminals	
Antenna input	: F type connector x 1
Antenna output	: F type connector x 1
Video input/output	: RCA connector x 2
Audio input/output	: RCA connector x 2

ELECTRICAL SPECIFICATIONS

Video output level	: 1Vp-p
Video output impedance	: 75Ω
Audio output level	: -6dBv (1KHz)
Video input level	: 0.5~2.0Vp-p
Audio input level	: -10dBv
Video S/N ratio	
SP	: More than 42dB
Audio S/N ratio	
SP	: More than 38dB

OTHER SPECIFICATIONS

Power requirement	: 120V, 60Hz
Power consumption	: 17 Watts
Dimensions	
W	: 14-1/4" (360mm)
H	: 3-5/8" (92mm)
D	: 10" (252mm)
Weight	: 7.0lbs. (3.2 Kg.) (Approx.)
Accessories, included	
Remote control unit	
2 "AA" Batteries	
Owner's Manual	
Coaxial cable	
Quick Guide	

• Designs and specifications are subject to change without notice.

CABLE CHANNEL DESIGNATIONS

This model is capable of receiving 125 cable channels. The channels are displayed as 1-125.

Cable companies often designate channels with letters or letter-number combinations. Please check with your local cable company. The following is a chart of common cable channel designations.

CATV Channel	5A	2	3	4	5	6	7	8	9	10	11	12	13	A	B
VCR Display	1	2	3	4	5	6	7	8	9	10	11	12	13	14	15
CATV Channel	C	D	E	F	G	H	I	J	K	L	M	N	O	P	Q
VCR Display	16	17	18	19	20	21	22	23	24	25	26	27	28	29	30
CATV Channel	R	S	T	U	V	W	W+1	W+2	W+3	W+4	W+5	W+6	W+7	W+8	W+9
VCR Display	31	32	33	34	35	36	37	38	39	40	41	42	43	44	45
CATV Channel	W+10	W+11	W+12	W+13	W+14	W+15	W+16	W+17	W+18	W+19	W+20	W+21	W+22	W+23	W+24
VCR Display	46	47	48	49	50	51	52	53	54	55	56	57	58	59	60
CATV Channel	W+25	W+26	W+27	W+28	W+29	W+30	W+31	W+32	W+33	W+34	W+35	W+36	W+37	W+38	W+39
VCR Display	61	62	63	64	65	66	67	68	69	70	71	72	73	74	75
CATV Channel	W+40	W+41	W+42	W+43	W+44	W+45	W+46	W+47	W+48	W+49	W+50	W+51	W+52	W+53	W+54
VCR Display	76	77	78	79	80	81	82	83	84	85	86	87	88	89	90
CATV Channel	W+55	W+56	W+57	W+58	A-5	A-4	A-3	A-2	A-1	W+59	W+60	W+61	W+62	W+63	W+64
VCR Display	91	92	93	94	95	96	97	98	99	100	101	102	103	104	105
CATV Channel	W+65	W+66	W+67	W+68	W+69	W+70	W+71	W+72	W+73	W+74	W+75	W+76	W+77	W+78	W+79
VCR Display	106	107	108	109	110	111	112	113	114	115	116	117	118	119	120
CATV Channel	W+80	W+81	W+82	W+83	W+84										
VCR Display	121	122	123	124	125										