

Quick Guide

DVD Recorder with Video Cassette Recorder WFR205

Playable discs

This unit is compatible to play the following discs.

Disc	Logo	Disc	Logo
DVD-VIDEO		CD-DA (AUDIO CD)	
DVD-RW (VIDEO/VR mode)		CD-RW (CD-DA FORMAT, MP3 files)	
DVD-R (VIDEO mode)		CD-R (CD-DA FORMAT, MP3 files)	

is a trademark of DVD Format/Logo Licensing Corporation.

• DVD+R/+RW discs are supported for playback only. *Some DVD+R/+RW discs are not compatible with this unit.

Region codes



The number inside the globe refers to region of the world. This unit can play DVDs that are labeled for ALL regions or for Region 1.

Recordable discs

This unit can record on DVD-R and DVD-RW discs.

DVD-R discs allow you to record programs only once. DVD-RW discs allow you to record programs repeatedly, and the recorded contents can be erased.

You can record programs on DVD-R discs only in Video mode, while recording format for DVD-RW discs can choose either Video mode or VR mode.

Disc type	Disc format	Functions	Attributes
 DVD-RW: 1-4x	Video mode 	Playing, limited recording, limited editing	8cm/12cm, single-sided, single layer disc Approx. max. recording time (SEP mode): 600 minutes (4.7GB) (for 12cm) 180 minutes (1.4GB) (for 8cm)
	VR mode 	Playing, recording, Original/Playlist editing	
 DVD-R: 1-16x	Video mode 	Playing, limited recording, limited editing	8cm/12cm, single-sided, single layer disc Approx. max. recording time (SEP mode): 600 minutes (4.7GB) (for 12cm) 180 minutes (1.4GB) (for 8cm)

NOTE: You can either use A/V connection or RF connection with this unit.

1

Connections

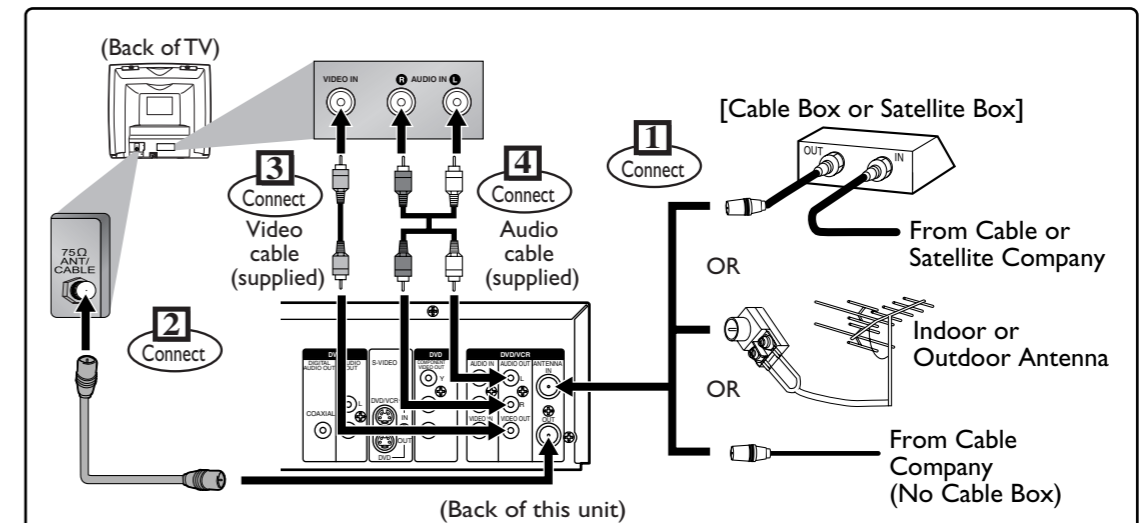

• See pages 14 and 15 of the Owner's Manual for the details.

2

Watching TV

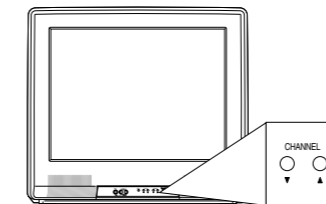

(Example of a TV)

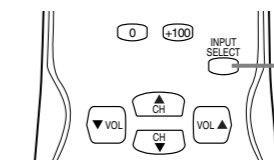

INPUT SELECT button

(Example of a TV remote control)

1. Switch the input selector on your TV to an appropriate external input channel (usually near channel 0).
2. Press a button on the TV's original remote control (see the table below) to select an external input channel until the DVD recorder's picture appears.

NOTE: These steps are for A/V cable connection only.

Input Mode Names for Common TV Brands

Brand	Input Mode Name	Brand	Input Mode Name
Admiral	AUX	LXI-Series	00
Curtis Mathis	LINE1, LINE2, 00, 90, 91, 92, 93	Magnavox	AUX CHANNEL
GE	INPUT, TV/VCR, 00, 90, 91, 92, 93	Panasonic	TV/VIDEO
Hitachi	INPUT, AUX	RCA	INPUT, TV/VCR, 00, 90, 91, 92, 93
JVC	A/V CHANNEL, INPUT1, SVIDEO, INPUT2	Samsung	TV/VIDEO
Kenwood	AUX	Sanyo	VIDEO
		Sharp	00
		Sony	VIDEO1, VIDEO2, VIDEO3
		Toshiba	TV/GAME
		Zenith	00

Press [SETUP].

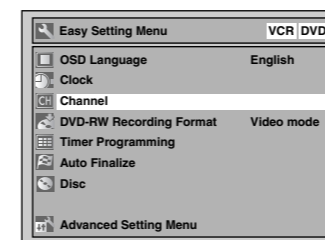

Using [▲/▼], select "Channel" from the Menu.

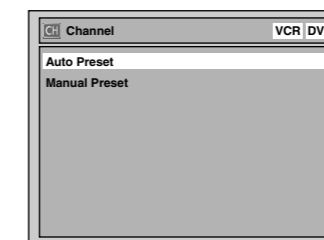

Select "Auto Preset" and the unit will start getting available channels in your area.

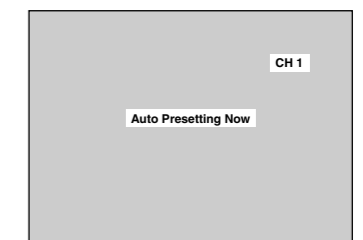

Follow to the back side of this sheet.

3

DVD Recording

3-1 Easy Recording

Press [DVD] on the remote control first.

Select the recording speed

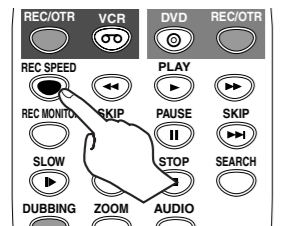

How to select the recording speed:

Disc Size	Recording speed	Recording time *	Video/Sound Quality
8cm Disc	XP (1H)	18 min	☆☆☆☆☆ (good)
	SP (2H)	36 min	☆☆☆☆☆
	LP (4H)	72 min	☆☆☆☆
	EP (6H)	108 min	☆☆☆
	SLP (8H)	144 min	☆☆
12 cm Disc	SEP (10H)	180 min	☆ (poor)
	XP (1H)	60 min	☆☆☆☆☆ (good)
	SP (2H)	120 min	☆☆☆☆☆
	LP (4H)	240 min	☆☆☆☆
	EP (6H)	360 min	☆☆☆
	SLP (8H)	480 min	☆☆
	SEP (10H)	600 min	☆ (poor)

Select the desired TV channel

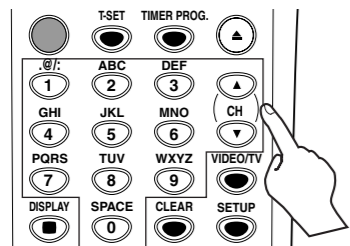

Record!

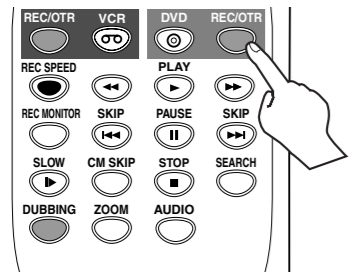

Press repeatedly to select desired recording time

Recording times appear on the TV screen (30 minutes to 8 hours). Recording will start.

(Normal Recording) 1:00

When the unit reaches the specified time, recording will stop automatically.

After all recordings, finalize your disc!

After recording, you must finalize the disc in order to play on other units.

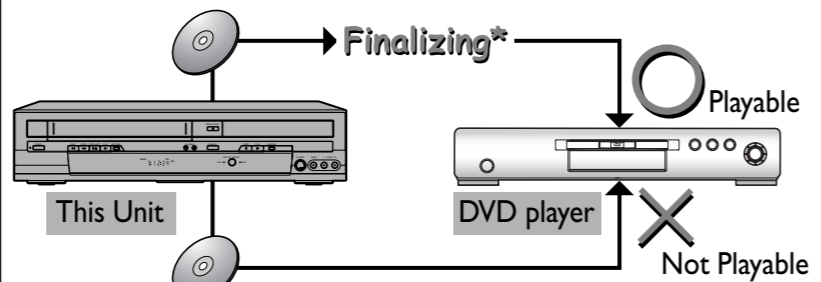

* You cannot finalize discs recorded in other DVD recorders.

To stop recording

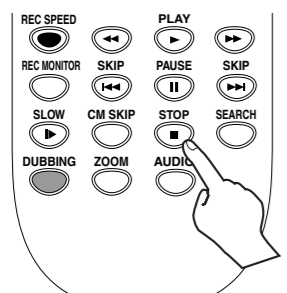

3-2 Timer Recording

- You can set up to 8 programs (once, daily or weekly).
- Be sure to set the clock before starting a timer programming.

Display the Timer Programming Screen

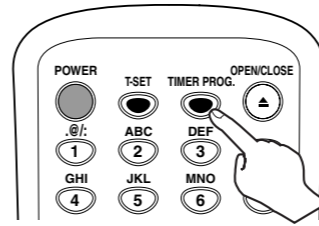

Timer Programming display appears. Select any blank line and press [ENTER].

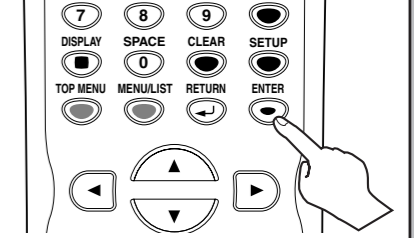
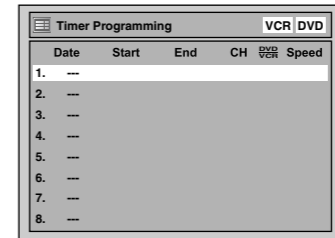

Set the date

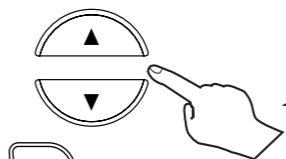
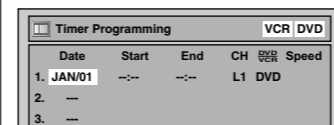

When pressing at the current date, Timer Recording mode will change as follows: e.g. January 1st at present

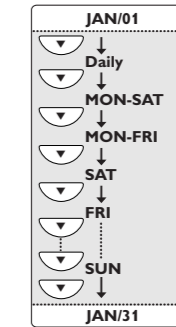

Move to next

Set start and end time

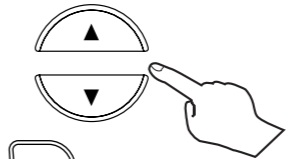
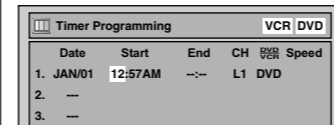

Move to next

Select the channel number to record

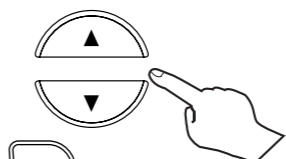
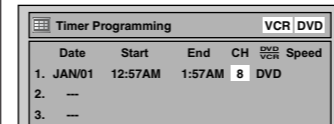

Move to next

Select the media to record

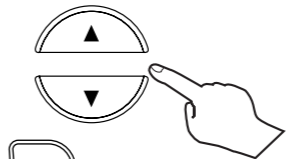
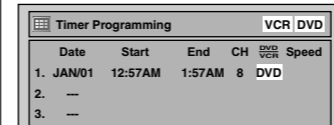

Move to next

Select the recording speed

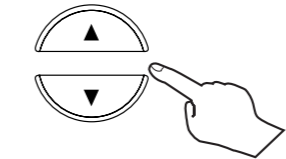
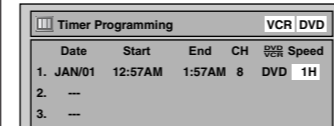

ENTER!



Timer Recording is now set.

Set the Timer Standby mode

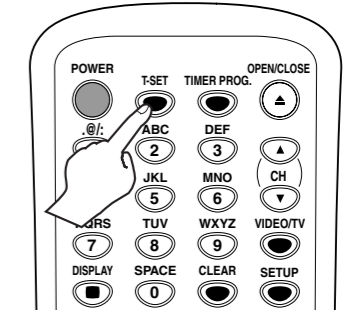

indicator will appear on the front display.

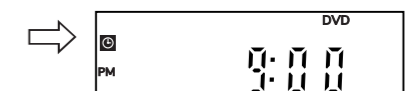

Hints for DVD Recording

- Formatting is not needed when inserting a blank disc. **UNIT AUTOMATICALLY PREPARES THE DISC FOR RECORDING.**
- You need to record in Video mode and finalize the disc to play it back on other players and **OTHER PLAYER MUST BE COMPATIBLE WITH DVD-R or DVD-RW.**

Owner's Manual

DVD Recorder with Video Cassette Recorder

WFR205

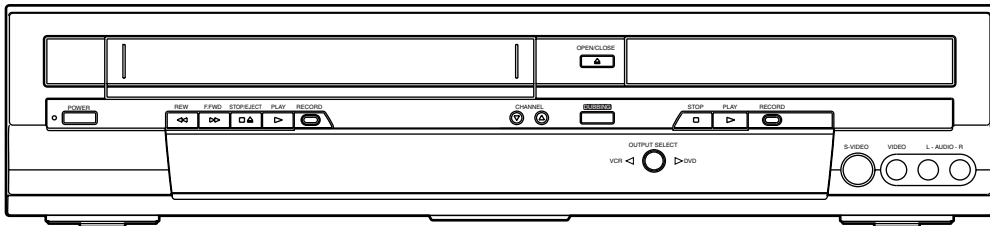

INSTRUCCIONES EN ESPAÑOL INCLUIDAS.

Supplied Accessory

- Remote control (NB171UD or NB121UD) with two AA batteries
- RF cable (WPZ0901TM002)
- Audio/Video cables (WPZ0102TM015 or WPZ0102LTE01)
- Owner's Manual (1VMN20770)
- Quick Use Guide (1VMN21068)
- Blank Media DVD-R

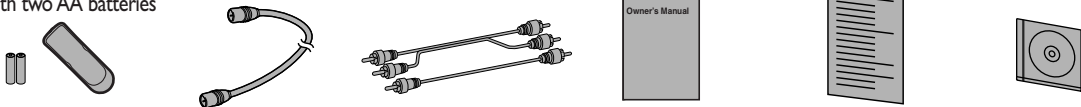

Please read before using this equipment.

If you need additional operating assistance after reading this owner's manual or to order replacement accessories, please call

TOLL FREE : 1-800-605-8453

or visit our web site at <http://www.Symphonic.us>

Before you use this unit, you need to complete connections. Refer to "Connections" on pages 14-16.

To record a program easily, refer to "Easy DVD recording" on pages 17-18 after connections are completed.

(You CANNOT record on any copyright protected DVD disc with this unit.)

Before you start

Precautions

WARNING: TO REDUCE THE RISK OF FIRE OR ELECTRIC SHOCK, DO NOT EXPOSE THIS APPLIANCE TO RAIN OR MOISTURE.



CAUTION
RISK OF ELECTRIC SHOCK
DO NOT OPEN



The lightning flash with arrowhead symbol, within an equilateral triangle, is intended to alert the user to the presence of uninsulated "dangerous voltage" within the product's enclosure that may be of sufficient magnitude to constitute a risk of electric shock to persons.



The exclamation point within an equilateral triangle is intended to alert the user to the presence of important operating and maintenance (servicing) instructions in the literature accompanying the appliance.

CAUTION:

TO REDUCE THE RISK OF ELECTRIC SHOCK, DO NOT REMOVE COVER (OR BACK). NO USER SERVICEABLE PARTS INSIDE. REFER SERVICING TO QUALIFIED SERVICE PERSONNEL.

Laser Safety

This unit employs a laser. Only a qualified service person should remove the cover or attempt to service this device, due to possible eye injury.

CAUTION: USE OF CONTROLS OR ADJUSTMENTS OR PERFORMANCE OF PROCEDURES OTHER THAN THOSE SPECIFIED HEREIN MAY RESULT IN HAZARDOUS RADIATION EXPOSURE.

CAUTION: VISIBLE AND INVISIBLE LASER RADIATION WHEN OPEN AND INTERLOCK DEFEATED. DO NOT STARE INTO BEAM.

LOCATION: INSIDE, NEAR THE DECK MECHANISM.

FCC WARNING- This equipment may generate or use radio frequency energy. Changes or modifications to this equipment may cause harmful interference unless the modifications are expressly approved in the instruction manual. The user could lose the authority to operate this equipment if an unauthorized change or modification is made.

RADIO-TV INTERFERENCE

This equipment has been tested and found to comply with the limits for a Class B digital device, pursuant to Part 15 of the FCC Rules. These limits are designed to provide reasonable protection against harmful interference in a residential installation. This equipment generates, uses, and can radiate radio frequency energy and, if not installed and used in accordance with the instructions, may cause harmful interference to radio communications. However, there is no guarantee that interference will not occur in a particular installation. If this equipment does cause harmful interference to radio or television reception, which can be determined by turning the equipment off and on, the user is encouraged to try to correct the interference by one or more of the following measures:

- 1) Reorient or relocate the receiving antenna.
- 2) Increase the separation between the equipment and receiver.
- 3) Connect the equipment into an outlet on a circuit different from that to which the receiver is connected.
- 4) Consult the dealer or an experienced radio/TV technician for help.

This Class B digital apparatus complies with Canadian ICES-003.

Cet appareil numérique de la classe B est conforme à la norme NMB-003 du Canada.

CAUTION: TO PREVENT ELECTRIC SHOCK, MATCH WIDE BLADE OF PLUG TO WIDE SLOT, FULLY INSERT.

ATTENTION: POUR ÉVITER LES CHOC ÉLECTRIQUES, INTRODUIRE LA LAME LA PLUS LARGE DE LA FICHE DANS LA BORNE CORRESPONDANTE DE LA PRISE ET POUSSER JUSQU'AU FOND.

A NOTE ABOUT RECYCLING

This product's packaging materials are recyclable and can be reused. Please dispose of any materials in accordance with your local recycling regulations.

Batteries should never be thrown away or incinerated but disposed of in accordance with your local regulations concerning chemical wastes.

Make your contribution to the environment!!!

- Used up batteries do not belong in the dust bin.
- You can dispose of them at a collection point for used up batteries or special waste. Contact your council for details.



For Customer Use:

Read carefully the information located at the back of this unit and enter below the Serial No. Retain this information for future reference.

Model No. _____

Serial No. _____

Before you start

Precautions (cont'd)

IMPORTANT SAFEGUARDS

1. Read Instructions - All the safety and operating instructions should be read before the appliance is operated.
2. Retain Instructions - The safety and operating instructions should be retained for future reference.
3. Heed Warnings - All warnings on the appliance and in the operating instructions should be adhered to.
4. Follow Instructions - All operating and use instructions should be followed.
5. Cleaning - Unplug this product from the wall outlet before cleaning. Do not use liquid cleaners or aerosol cleaners. Use a damp cloth for cleaning.
EXCEPTION: A product that is meant for uninterrupted service and, that for some specific reason, such as the possibility of the loss of an authorization code for a CATV converter; is not intended to be unplugged by the user for cleaning or any other purpose, may exclude the reference to unplugging the appliance in the cleaning description otherwise required in item 5.
6. Attachments - Do not use attachments not recommended by the product manufacturer as they may cause hazards.
7. Water and Moisture - Do not use this product near water, for example, near a bath tub, wash bowl, kitchen sink, or laundry tub, in a wet basement, or near a swimming pool, and the like.
8. Accessories - Do not place this product on an unstable cart, stand, tripod, bracket, or table. The product may fall, causing serious injury to a child or adult, and serious damage to the appliance. Use only with a cart, stand, tripod, bracket, or table recommended by the manufacturer, or sold with the product. Any mounting of the appliance should follow the manufacturer's instructions and should use a mounting accessory recommended by the manufacturer. An appliance and cart combination should be moved with care. Quick stops, excessive force, and uneven surfaces may cause the appliance and cart combination to overturn.
PORTABLE CART WARNING
(Symbol provided by RETAC)

S3125A
9. Ventilation - Slots and openings in the cabinet are provided for ventilation and to ensure reliable operation of the product and to protect it from overheating, and these openings must not be blocked or covered. The openings should never be blocked by placing the product on a bed, sofa, rug, or other similar surface. This product should not be placed in a built-in installation such as a bookcase or rack unless proper ventilation is provided or the manufacturer's instructions have been adhered to.
10. Power Sources - This product should be operated only from the type of power source indicated on the marking label. If you are not sure of the type of power supply to your home, consult your appliance dealer or local power company. For products intended to operate from battery power, or other sources, refer to the operating instructions.
11. Grounding or Polarization - This product is equipped with a polarized alternating-current line plug (a plug having one blade wider than the other). This plug will fit into the power outlet only one way. This is a safety feature. If you are unable to insert the plug fully into the outlet, try reversing the plug. If the plug should still fail to fit, contact your electrician to replace your obsolete outlet. Do not defeat the safety purpose of the polarized plug.
12. Power Cord Protection - Power supply cords should be routed so that they are not likely to be walked on or pinched by items placed upon or against them, paying particular attention to cords at plugs, convenience receptacles, and the point where they exit from the appliance.
13. Outdoor Antenna Grounding - If an outside antenna or cable system is connected to the product, be sure the antenna or cable system is grounded so as to provide some protection against voltage surges and built-up static charges. Article 810 of the National Electrical Code, ANSI/NFPA No. 70, provides information with regard to proper grounding of the mast and sup-

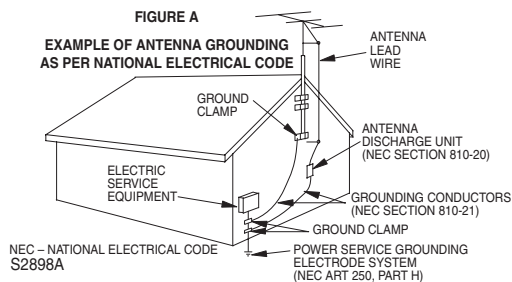
porting structure, grounding of the lead-in wire to an antenna discharge unit, size of grounding conductors, location of antenna-discharge unit, connection to grounding electrodes, and requirements for the grounding electrode. (Fig. A)



14. Lightning - For added protection for this product during a lightning storm, or when it is left unattended and unused for long periods of time, unplug it from the wall outlet and disconnect the antenna or cable system. This will prevent damage to the product due to lightning and power-line surges.
15. Power Lines - An outside antenna system should not be located in the vicinity of overhead power lines or other electric light or power circuits, or where it can fall into such power lines or circuits. When installing an outside antenna system, extreme care should be taken to keep from touching such power lines or circuits as contact with them might be fatal.
16. Overloading - Do not overload wall outlets and extension cords as this can result in a risk of fire or electric shock.
17. Object and Liquid Entry - Never push objects of any kind into this product through any openings as they may touch dangerous voltage points or short-out parts that could result in a fire or electric shock. Never spill liquid of any kind on the product.
18. Servicing - Do not attempt to service this product yourself as opening or removing covers may expose you to dangerous voltage or other hazards. Refer all servicing to qualified service personnel.
19. Damage Requiring Service - Unplug this product from the wall outlet and refer servicing to qualified service personnel under the following conditions:
 - a. When the power-supply cord or plug is damaged.
 - b. If liquid has been spilled, or objects have fallen into the product.
 - c. If the product has been exposed to rain or water.
 - d. If the product does not operate normally by following the operating instructions. Adjust only those controls that are covered by the operating instructions as an improper adjustment of other controls may result in damage and will often require extensive work by a qualified technician to restore the product to its normal operation.
 - e. If the product has been dropped or damaged in any way.
 - f. When the product exhibits a distinct change in performance this indicates a need for service.
20. Replacement Parts - When replacement parts are required, be sure the service technician has used replacement parts specified by the manufacturer or have the same characteristics as the original part. Unauthorized substitutions may result in fire, electric shock or other hazards.
21. Safety Check - Upon completion of any service or repairs to this product, ask the service technician to perform safety checks to determine that the product is in proper operating condition.
22. Heat - This product should be situated away from heat sources such as radiators, heat registers, stoves, or other products (including amplifiers) that produce heat.

Before you start

Precautions (cont'd)

Installation Location

For safety and optimum performance of this unit:

- Install the unit in a horizontal and stable position. Do not place anything directly on top of the unit. Do not place the unit directly on top of the TV.
- Shield it from direct sunlight and keep it away from sources of intense heat. Avoid dusty or humid places. Avoid places with insufficient ventilation for proper heat dissipation. Do not block the ventilation holes on the sides of the unit. Avoid locations subject to strong vibration or strong magnetic fields.

Avoid the Hazards of Electrical Shock and Fire

- Do not handle the power cord with wet hands.
- Do not pull on the power cord when disconnecting it from AC wall outlet. Grasp it by the plug.
- If, by accident, water is spilled on this unit, unplug the power cord immediately and take the unit to our Authorized Service Center for servicing.

Moisture Condensation Warning

Moisture condensation may occur inside the unit when it is moved from a cold place to a warm place or after heating a cold room or under conditions of high humidity. Do not use this unit at least for 2 hours until its inside gets dry.

About Copyright

Unauthorized copying, broadcasting, public performance and lending of discs are prohibited.

This product incorporates copyright protection technology that is protected by U.S. patents and other intellectual property rights. Use of this copyright protection technology must be authorized by Macrovision, and is intended for home and other limited viewing uses only unless otherwise authorized by Macrovision.

Reverse engineering or disassembly is prohibited.

Before you start

Precautions (cont'd)

Maintenance

SERVICING

- Please refer to relevant topics on the Troubleshooting Guide on pages 78-81 before returning the product.
- If this unit becomes inoperative, do not try to correct the problem by yourself. There are no user-serviceable parts inside. Turn off, unplug the power plug and please call our help line mentioned on the front page to locate an Authorized Service Center.

CLEANING THE CABINET

- Use a soft cloth slightly moistened with a mild detergent solution. Do not use a solution containing alcohol, spirits, ammonia or abrasive.

CLEANING DISCS

- When a disc becomes dirty, clean it with a cleaning cloth. Wipe the disc from the center out. Do not wipe in a circular motion.
- Do not use solvents such as benzine, thinner, commercially available cleaners, detergent, abrasive cleaning agents or antistatic spray intended for analogue records.

CLEANING THE DISC LENS

- If this unit still does not perform properly although you refer to the relevant sections and to “Troubleshooting” in this Owner’s Manual, the laser optical pickup unit may be dirty. Consult your dealer or an Authorized Service Center for inspection and cleaning of the laser optical pickup unit.

DISC HANDLING

- Handle the discs so that fingerprints and dust do not adhere to the surfaces of the discs.
- Always store the disc in its protective case when it is not used.

AUTO HEAD CLEANING

- Automatically cleans video heads as you insert or remove a cassette, so you can see a clear picture.
- Playback picture may become blurred or interrupted while the TV program reception is clear. Dirt accumulated on the video heads after a long period of use, or the usage of rental or worn tapes can cause this problem. If a streaky or snowy picture appears during playback, the video heads in the unit may need to be cleaned.

1. Please visit your local Audio/Video store and purchase a good quality VHS Video Head Cleaner.
2. If a Video Head Cleaner does not solve the problem, please call our help line mentioned on the front page to locate an Authorized Service Center.

NOTES:

- Remember to read the instructions along with the video head cleaner before use.
- Clean video heads only when problems occur.

Manufactured under license from Dolby Laboratories. “Dolby” and the double-D symbol are trademarks of Dolby Laboratories.

Dolby Digital Recording

“Dolby® Digital Recording enables consumers to record high-quality video with stereo sound on recordable DVD discs. The technology, when utilized instead of PCM recording, also saves recordable disc space, allowing for higher video resolution or extended recording time on each DVD. DVDs created using Dolby Digital Recording will play back on all DVD-Video players.”

Note: This is true when the players are compatible with actual recordable DVD discs.

Before you start

Table of contents

Before you start	2	Slow forward / Slow reverse playback	45
Precautions	2	Zoom	46
Laser Safety	2	Marker Setup	46
Important safeguards	3	Search	47
Table of contents	6	Title/Chapter search	47
Features	7	Track search	48
Functional overview	8	Time search	48
Installing batteries in the remote control	10	Repeat/Random/Program playback	49
Using a remote control	10	Repeat playback	49
The VCR/DVD recorder Switching	10	Random playback	49
Setting/DISC/CD menu	11	Program playback	50
DISPLAY menu	12	Selecting a format of audio and video	50
Connections	14	Switching subtitles	50
Connection to a TV	14	Switching audio soundtrack	51
Connection to a cable box or satellite box	15	Switching camera angles	52
Connection to an Audio System	16	Visual Noise Reduction	52
Getting started	17	Editing	53
Easy DVD recording	17	Information on disc editing	53
Channel setting	19	Guide to a title list	53
Getting channels automatically	19	Editing discs in Video mode	53
Adding/deleting channels	20	Editing discs in VR mode	53
Selecting the TV stereo or SAP	21	Editing discs in Video mode	54
Setting the clock	22	Deleting titles	54
Auto Clock Setting	22	Putting names on titles	55
Manual Clock Setting	23	Setting or clearing chapter markers	56
Setting the daylight saving time	24	Editing discs in VR mode (Original)	57
Selecting the TV aspect ratio	24	Deleting titles	57
Recording	25	Setting titles to protect	58
Information on DVD recording	25	Releasing titles from protecting	59
Information	25	Editing discs in VR mode (Playlist)	60
Recordable disc	25	Deleting titles	60
Recording speed	25	Deleting parts of titles	61
Restrictions on recording	26	Putting names on titles	62
Information on copy control	26	Setting or clearing chapter markers	63
Making discs playable on other DVD player (Finalize)	26	Setting pictures for thumbnails	64
Formatting a disc	27	Dividing a title	65
Choosing the recording format of a blank disc	27	Combining titles	66
Reformatting a disc	28	Adding titles to a Playlist	67
Basic recording	29	Deleting a Playlist	67
Checking the recording picture and sound quality	29	Changing the Setting menu	68
One-touch Timer Recording	30	Tour of the Setting menu	68
Timer Recording	31	Language setting	69
Hints for Timer Recording	33	Display setting	70
Settings for an external source	34	Audio setting	71
Connection to an external source	34	Settings for Parental lock level	73
Recording from an external source	35	VCR functions	75
Setting a disc to protect	35	Playback	75
Finalizing the discs	36	Recording and One-touch Timer Recording	75
Auto finalize	37	Recording	75
Dubbing Mode	38	One-touch Timer Recording	76
Disc playback	40	Search	76
Information on DVD playback	40	Index search	76
Basic playback	41	Time search	77
Playback	41	Other operations	77
Playing back MP3 disc	42	Others	78
Playing back discs using the disc menu	43	Troubleshooting	78
Playing back discs using the title menu	43	RF output switch	81
Special playback	44	Glossary	82
Resume playback	44	Language code	82
Fast forward / Fast reverse	44	Frequently Asked Questions	83
Skipping TV commercials during playback	44	Specifications	83
Pause	45	Español	84
Step by step playback	45	Warranty	Back Cover

Before you start

Features

This unit not only plays back DVDs, CDs and VHS tapes but also offers features for you to record on DVD discs and edit them after that. The following features are offered with this unit.

Recording

DVD mode VCR mode

This unit is compatible with both DVD-RW, which is rewritable repeatedly, and DVD-R, which is available for one-time recording only. Also, this unit allows you to record to the videotape. You can choose either one for your convenience.

Recording up to 8 programs:

You can program the unit to record up to 8 programs within a month in advance. Daily or weekly program recordings are also available.

One-touch Timer Recording:

You can easily set recording time as you prefer. Every time [REC/OTR] is pressed during recording, the recording time will be increased by 30 minutes up to 8 hours. The recording automatically stops when it reached to the recording time you set.

Dubbing mode:

You can copy a DVD disc to a videotape or copy a videotape to a DVD disc. This function will be possible only if the DVD disc or a videotape is not copy protected.

You cannot record on a videotape when its record tab is removed.

Left channel stereo recording:

This unit can record the Left channel monaural sound as Left and Right channel sound automatically.

[REC MONITOR]:

You can confirm the picture and sound quality for recording of the current recording speed which you set.

If you want to change the recording speed, press

[REC SPEED] to set the desired recording mode.

Automatic Chapter marker setting:

You can mark each title of recording with chapter markers as you set in the Setting menu before recording.

Automatic Title menu making (Video mode):

The unit makes title menus automatically when finalizing the disc.

Automatic PLAYLIST making (VR mode):

A Playlist will be prepared from an Original list, so that you can edit titles on a Playlist as you prefer. An Original list is kept as it is.

Automatic finalizing (Video mode):

The unit can finalize discs automatically after finishing all Timer Recordings or when the disc runs out recordable space.

Playback

DVD mode

Theater quality sound at your home:

When connecting the unit to an amplifier or a decoder which is compatible with Dolby Digital, you can experience the theater-quality sound environment.

Quick search for what you want to watch:

You can easily find the part you want to watch using title, chapter or time search functions.

Start Playback from Original and Playlist (VR mode):

You can play back titles from either the Original list or the Playlist.

VCR mode

Quick search for what you want to watch:

You can easily find the part you want to watch using the Index search/Time search. An index mark will be assigned at the beginning of each recordings you make. For Time search, you can go to a specific point on a videotape by entering the exact amount of time you wish to skip.

Editing

DVD mode

Deleting titles:

You can delete titles which you do not need anymore.

Making your own Playlist (VR mode):

With the Original remains as it is, you can edit titles on Various playlist as you prefer.

Putting names on titles.

Setting pictures for thumbnails.

Setting/clearing chapter markers.

Dividing / Combining titles.

Deleting parts of titles, etc.

Protecting titles (VR mode):

You can prevent accidental editing or title erasing, with this function.

Compatibility

DVD mode

Playback of discs recorded in Video mode on a regular DVD player (Video mode):









Discs recorded in Video mode can be played back on regular DVD players, including computer DVD drives compatible with DVD-Video playback*. You will need to finalize the discs recorded in Video mode to play them back on other DVD players.

* DVD-Video Format (Video mode) is a new format for recording on DVD-RW/R discs that was approved by the DVD Forum in 2000. Adoption of this format is optional for manufactures of DVD playback devices, and there are DVD-Video players, DVD-ROM drives or other DVD playback devices that do not play back DVD-RW/R discs recorded in the DVD-Video Format.

Symbol in this Owner's Manual

The available functions depend on the type of disc or the recording mode.

To specify disc type or recording mode for each function, we put the following symbols at the beginning of each function.

Symbol	Description
	Available to DVD Video discs
	Available to DVD-RW in Video mode
	Available to DVD-RW in VR mode
	Available to DVD-R discs
	Available to Audio CDs
	Available to CD-RW/R discs with MP3 files
	Available to VHS tapes Use only [VHS] tapes marked with this unit.
First: (Press: )	Indicates that you need to select the DVD mode by pressing [DVD] on the remote control before proceeding next step.
First: (Press: )	Indicates that you need to select the VCR mode by pressing [VCR] on the remote control before proceeding next step.

Before you start

Functional overview

Front Panel

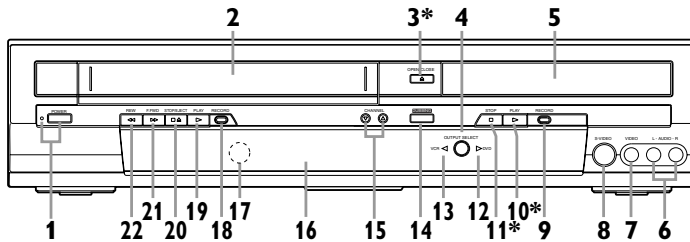

(*) The unit can also be turned on by pressing these buttons.

1. **POWER button / indicator (DVD/VCR)**
Press to turn on and off the unit. Red LED lights up when power is on.
2. **Cassette compartment (VCR)**
Insert a videotape here.
3. **OPEN/CLOSE ▲ button (DVD)***
Press to open or close the disc tray.
4. **OUTPUT SELECT button (DVD/VCR)**
Press to select the component you wish to operate.
5. **Disc tray (DVD)**
Place a disc when it is open.
6. **AUDIO input jacks (LINE2) (DVD/VCR)**
Use to connect external equipment with standard audio cables.
7. **VIDEO input jack (LINE2) (DVD/VCR)**
Use to connect external equipment with a standard video cable.
8. **S-VIDEO input jack (LINE2) (DVD/VCR)**
Use to connect the S-Video output of external equipment with an S-Video cable.
9. **RECORD button (DVD)**
Press once to start recording. Press repeatedly to start a One-Touch Timer Recording.
10. **PLAY ► button (DVD)***
Press to start or resume play.
11. **STOP ■ button (DVD)***
Press to stop playback or recording. Press to stop the proceeding Timer Recording in DVD.
12. **DVD indicator**
Appears when the DVD output mode is selected.
13. **VCR indicator**
Appears when the VCR output mode is selected.
14. **DUBBING button (DVD/VCR)**
Press to start VCR to DVD (DVD to VCR) duplication which you set in the Setting menu.
15. **CHANNEL ▼ / ▲ button (DVD/VCR)**
Press to change the channel up and down.
16. **Display**
Shows various information and messages.
17. **Remote control sensor (DVD/VCR)**
Receive signals from your remote control so that you can control the unit from a distance.
18. **RECORD button (VCR)**
Press once to start a recording. Press repeatedly to start a One-Touch Timer Recording.
19. **PLAY ► button (VCR)**
Press to start playback.
20. **STOP ■ / EJECT ▲ button (VCR)**
EJECT ▲ button-Press to remove the videotape from the cassette compartment when the power is on or off.
STOP ■ button-Press to stop videotape playback or recording.
21. **FFWD ►► button (VCR)**
Press to stop the proceeding Timer Recording in VCR.
Press to rapidly advance the videotape, or view the picture rapidly in forward during playback. (Forward Search)
22. **REW ◀◀ button (VCR)**
Press to rewind the videotape, or to view the picture rapidly in reverse during the playback mode. (Rewind Search)

Rear Panel

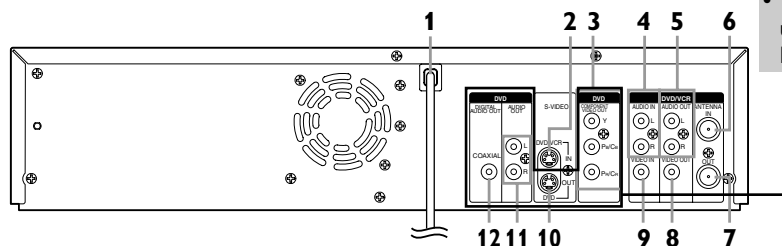

• These jacks are useful only in DVD mode.

1. **AC Power Cord (DVD/VCR)**
Connect to a standard AC outlet to supply power to this unit.
2. **S-VIDEO IN jack (LINE1) (DVD/VCR)**
Use to connect the S-Video output of external equipment with an S-Video cable.
3. **COMPONENT VIDEO OUTPUT jacks (DVD only)**
Use to connect a TV monitor with component video inputs with component video cables.
4. **AUDIO IN jacks (LINE1) (DVD/VCR)**
Use to connect external equipment with standard audio cables.
5. **AUDIO OUT jacks (DVD/VCR)**
Use to connect a TV monitor, AV receiver or other equipment with standard audio cables.
6. **TV ANTENNA IN jack (DVD/VCR)**
Use to connect an antenna.
7. **TV ANTENNA OUT jack (DVD/VCR)**
Use to connect an antenna cable to pass the signal from the TV ANTENNA IN to your TV monitor.
8. **VIDEO OUT jack (DVD/VCR)**
Use to connect a TV monitor, AV receiver or other equipment with a standard video cable.
9. **VIDEO IN jack (LINE1) (DVD/VCR)**
Use to connect external equipment with a standard video cable.
10. **S-VIDEO OUT jack (DVD only)**
Use to connect the S-Video input of a TV monitor, AV receiver or other equipment with an S-Video cable.
11. **AUDIO OUT jacks (DVD only)**
Use to connect a TV monitor, AV receiver or other equipment with standard audio cables.
12. **COAXIAL DIGITAL AUDIO OUTPUT jack (DVD only)**
Use to connect an AV receiver, Dolby Digital decoder or other equipment with a coaxial digital input jack with a digital coaxial cable.

Note: Do not touch the inner pins of the jacks on the rear panel. Electrostatic discharge may cause permanent damage to the unit.

Before you start

Functional overview (cont'd)

Remote Control

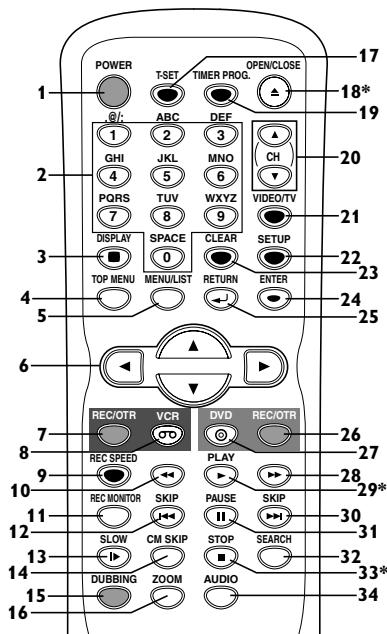

(*) In DVD mode, the unit can also be turned on by pressing these buttons.

1. **POWER button (DVD/VCR)**
Press to turn on and off the unit.
2. **Number buttons (DVD/VCR)**
Press to select channel numbers.
Press to select a title / chapter / track on display.
Also press to enter values for the settings in the Setting menu.
Also press to start the index/time search in VCR mode.
3. **DISPLAY button (DVD/VCR)**
Press to display the on-screen menu.
4. **TOP MENU button (DVD)**
Press to display the top menu.
5. **MENU/LIST button (DVD)**
Press to display the Disc menu.
Press to change ORIGINAL and PLAYLIST on the TV screen.
(VR mode only)
6. **Cursor \blacktriangle / \blacktriangledown / \blacktriangleleft / \blacktriangleright buttons (DVD/VCR)**
Press to select items or settings.
7. **REC/OTR button (VCR)**
Press to activate the remote control in VCR mode (refer to page 10).
Press once to start a recording.
Press repeatedly to start a One-Touch Timer Recording.
8. **VCR ∞ button**
Press to activate the remote control in VCR mode (refer to page 10).
Press to select the VCR output mode.
9. **REC SPEED button (DVD/VCR)**
Press to change the recording speed.
10. **$\blacktriangleleft\blacktriangleleft$ button (DVD/VCR)**
• DVD mode
During playback, press to play back in fast reverse.
Or when playback is paused, press to play back in slow reverse.
• VCR mode
Press to rewind the videotape or to view the picture rapidly in reverse during the playback mode.
11. **REC MONITOR button (DVD)**
Press to check the video and audio signals for recording.
12. **SKIP $\blacktriangleleft\blacktriangleleft$ button (DVD)**
During playback, press to skip to the previous chapter or track.
Or when playback is paused, press to play back in reverse step by step.
13. **SLOW \blacktriangleright button (VCR)**
During playback, press to view the videotape in slow motion.
14. **CM SKIP button (DVD)**
During playback, press to skip to the 30 second advanced point.
15. **DUBBING button (DVD/VCR)**
Press to start VCR to DVD (DVD to VCR) duplication which you set in the Setting menu.
16. **ZOOM button (DVD)**
During playback, press to enlarge the picture on the screen.
17. **T-SET button (DVD/VCR)**
Press to set the unit in the timer standby mode. In the timer standby mode, press to cancel the mode and to turn the unit on.
18. **OPEN/CLOSE \blacktriangle button (DVD)***
Press to open or close the disc tray.
19. **TIMER PROG. button (DVD/VCR)**
Press to display the timer program setting menu.
20. **CH \blacktriangle / \blacktriangledown buttons (DVD/VCR)**
• DVD mode
Press to change the channel up and down.
• VCR mode
Press to change the channel up and down.
Press to adjust the tracking during playback or in slow motion of the videotape.
Also while playback is in still mode, you can adjust the picture blurred vertically.
21. **VIDEO/TV button (DVD/VCR)**
Press to select VIDEO or TV position.
22. **SETUP button (DVD/VCR)**
Press to display the Setting menu.
23. **CLEAR button (DVD/VCR)**
• DVD mode
Press to clear the password entered, to cancel the programming for CD, to clear the highlighted marker number in the marker setup mode or to clear the program once entered in the Timer Recording setting mode, etc.
• VCR mode
Press to reset the tape counter.
24. **ENTER button (DVD/VCR)**
Press to confirm or select menu items.
25. **RETURN \blacktriangleleft button (DVD/VCR)**
Press to return to the previously displayed menu screen.
26. **REC/OTR button (DVD)**
Press to activate the remote control in DVD mode (refer to page 10).
Press once to start a recording.
Press repeatedly to start a One-Touch Timer Recording.
27. **DVD \odot button**
Press to activate the remote control in DVD mode (refer to page 10).
Press to select the DVD output mode.
28. **$\blacktriangleright\blacktriangleright$ button (DVD/VCR)**
• DVD mode
During playback, press to play back in fast forward.
Or when playback is paused, press to play back in slow forward.
• VCR mode
Press to rapidly advance the videotape or view the picture rapidly in forward during playback.
29. **PLAY \blacktriangleright button* (DVD/VCR)**
Press to start or resume playback.
30. **SKIP $\blacktriangleright\blacktriangleright$ button (DVD)**
During playback, press to skip to the next chapter or track.
Or when playback is paused, press to play back in forward step by step.
31. **PAUSE \parallel button (DVD/VCR)**
Press to pause playback or recording.
32. **SEARCH button (VCR)**
Press to call up the index or time search menu.
33. **STOP \blacksquare button* (DVD/VCR)**
Press to stop playback or recording.
34. **AUDIO button (VCR)**
During playback a HiFi videotape, press to change the AUDIO OUT setting "HIFI" and "MONO".

Before you start

Functional overview (cont'd)

Installing batteries in the remote control

Install two "AA" size batteries (supplied), matching their polarity to those indicated inside battery compartment of the remote control.

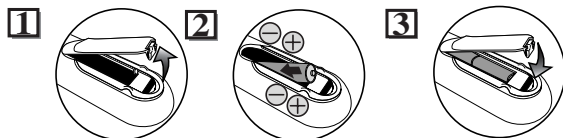

Note:

Incorrect use of batteries can result in hazards such as leakage and bursting. Please follow the instruction below:

- Do not mix new and old batteries together.
- Do not use different kinds of batteries together. Although they may look similar, different batteries may have different voltages.
- Make sure that the plus and minus ends of each battery match the indications in the battery compartment.
- Remove batteries from equipment that is not going to be used for a month or more.
- When disposing used batteries, please comply with governmental regulations or public rules for environmental protection that apply in your country or area.
- Do not recharge, short-circuit, heat, burn or disassemble batteries.

Using a remote control

Keep in mind the following when using the remote control:

- Make sure that there is no obstacle between the remote control and the remote sensor of the unit.
- Remote operation may become unreliable if strong sunlight or fluorescent light is on the remote sensor of the unit.
- Remote control for different devices can interfere with each other. Avoid using remote control for other equipment located close to the unit.
- Replace the batteries when you notice a fall-off of the operating range of the remote control.
- The maximum operable ranges from the unit are as follows.
 - **Beeline:** approx. 23 feet (7m)
 - **Either side of the center:** approx. 16 feet (5m) within 30°
 - **Above:** approx. 16 feet (5m) within 15°
 - **Below:** approx. 10 feet (3m) within 30°

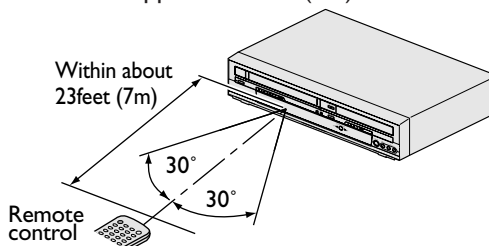

The VCR/DVD recorder Switching

Because this product is a combination of a VCR and a DVD recorder, you must select first which component you wish to operate with **[OUTPUT SELECT]**.

VCR MODE

Press **[VCR]** on the remote control.
(Verify that the VCR indicator is lit.)

DVD MODE

Press **[DVD]** on the remote control.
(Verify that the DVD indicator is lit.)

Notes:

- Pressing only **[OUTPUT SELECT]** on the front panel DOES NOT switch the mode of the remote control. You MUST select the correct mode on the remote control.
- You cannot switch to another mode (DVD or VCR) during in the timer-standby mode.
- Pressing **[REC/OTR]** (DVD) or **[REC/OTR]** (VCR) on the remote control switches immediately its respective mode so that you can start recording directly on the appropriate media.

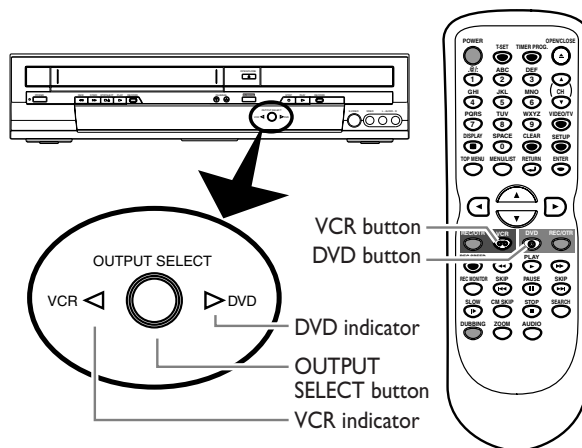

Guide to Displays on-screen menu

This unit uses the following on-screen menu for most operations: Easy Setting Menu, Advanced Setting Menu, Title list, Playlist, Original and Display menu. They allow you to change the playback status of the disc during playback.

The DISPLAY menu also gives you information on the playback status of the disc or a videotape.

Setting/DISC/CD menu

Press **[SETUP]** to display Easy Setting Menu or Advanced Setting Menu. Choose either Menu using **[▲ / ▼]**, then press **[ENTER]** to display it.

These menus allow you to perform all main functions and change setting for them.

Easy Setting Menu and Advanced Setting Menu are available. Easy Setting Menu consists of those frequently needed. You can make all required setting using Advanced Setting Menu. Items with  mark can be set in both menus.

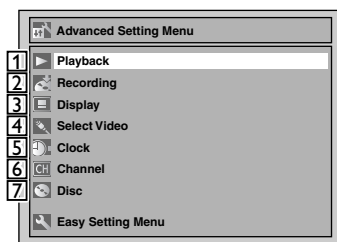
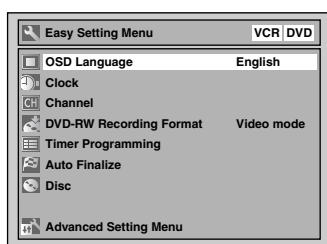

1. Playback:

To set up the unit to play back discs as you prefer.

2. Recording:

To set up the unit to record on discs or tapes as you prefer.

3. Display:

To set up the OSD screen and the front display of the unit as you prefer.

4. Select Video:

To choose a line input to record on DVD discs or tapes from other video equipment.

5. Clock:

To set up the clock of the unit.

6. Channel:

To adjust the channel setting of the unit as you prefer.

7. Disc / CD Playback Mode:

“Disc” is available only when a DVD-RW/R disc is inserted into the unit. When a DVD-Video disc (commercially available), a new DVD-R disc or a finalized DVD-R disc is inserted into the unit, you cannot select “Disc”.

“CD Playback Mode” is available only when an Audio CD disc or a CD-RW/R disc with MP3 files is inserted into the unit.

<DVD-R, DVD-RW (Video mode)>

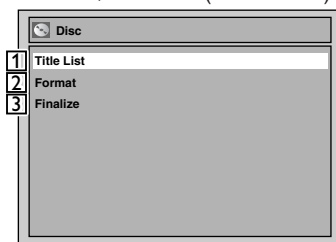

<DVD-RW (VR mode)>

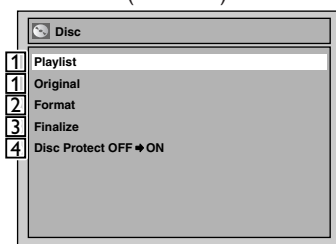

<CD, MP3>

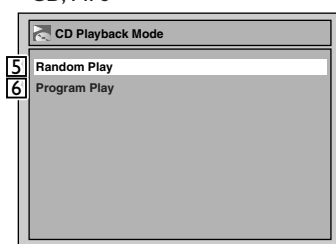

1. Title List / Playlist / Original:

Turns on a title list, playlist or Original, which shows the recorded titles on the disc.

2. Format (DVD-RW only):

Allows you to erase all of the recorded content on the disc.

The disc will be completely blank.

• Erased content cannot be retrieved.
• A DVD-RW disc formatted with this unit cannot be used on other DVD recorders for recording.

• If you want to use a disc formatted with this unit on another DVD recorder, you have to re-format the disc on that recorder.

3. Finalize:

Allows you to finalize a disc with titles recorded on this unit only.

• **4. Disc Protect (VR mode only):** Allows you to protect a disc from accidental editing or recording.

5. Random Play:

To activate the random playback.

6. Program Play (Audio CD only):

To activate the programmed playback.

Before you start

Functional overview (cont'd)

DISPLAY menu

DVD mode





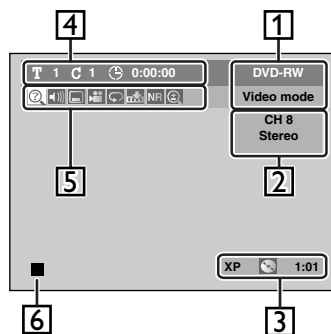

First: 

Press **[DISPLAY]** to call up the display menu. This menu will give you the information on the disc. Some operations are available while disc is played back.



1. Indicates a disc type and a format mode.
Note: In some descriptions on this manual, only one disc type is indicated as an example.
2. Indicates a current channel number and an audio status of the program.
3. Indicates a recording mode and possible recording time left.
4. Indicates a title number, chapter number and the time elapsed of disc play.

5. Each icon means:

-  : Search
-  : Audio
-  : Subtitle
-  : Angle (except VR mode)
-  : Repeat
-  : Marker
- NR** : Noise Reduction
-  : Zoom

6. Indicates current disc status.

Note:

- This is an example screen only for explanation. Displayed items will change depending on the actual mode.
- DISPLAY function is not available when no disc is inserted.

VCR mode

First: 

Press **[DISPLAY]** to display the onscreen display.

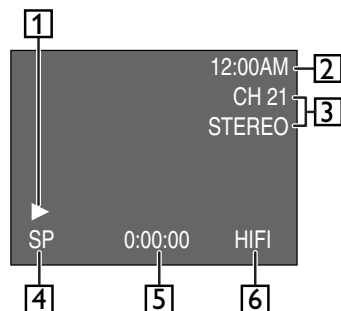

1. Indicates current video status.
2. Indicates the current time.
3. Indicates a current channel number and an audio status of the program.
4. Indicates a recording or playing speed.
5. Indicates a Tape Counter.
6. Audio status of the current videotape.

Note:

- This is an example screen only for explanation. Displayed items will change depending on the actual mode.

Front Panel Display Guide

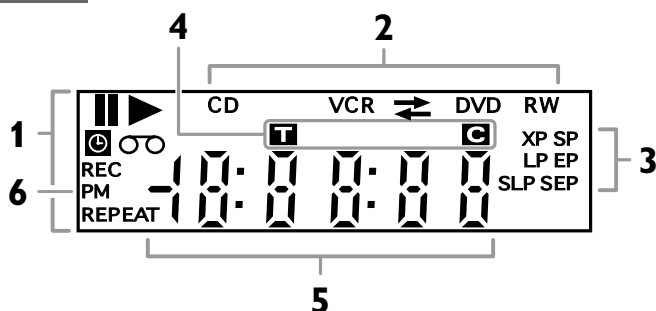

1. Current status of the unit

|| : Appears when a disc or a videotape play is paused.

▶ : Appears when playing back a disc or a videotape.

⌚ : Appears when the timer programming or OTR has been set and is proceeding. Flashes when all Timer Recordings have been finished.

REC : Appears during recording process. Flashes when a recording pauses.

REPEAT : Appears during repeat playback (disc playback only).

⊙ : Appears when a videotape is in the unit.

2. Disc type and Current status of the unit

CD : Appears when an audio CD or a disc with MP3 files is on the disc tray.

DVD : Appears when a DVD disc is on the disc tray. Appears when the Timer Recording is proceeding in DVD.

Appears when DVD is in the Timer Recording standby mode.

Flashes when a program cannot be performed with some reasons.

DVD R : Appears when a DVD-R disc is on the disc tray.

DVD RW : Appears when a DVD-RW disc is on the disc tray.

VCR : Appears when the Timer Recording is proceeding in VCR.

Appears when VCR is in the Timer Recording standby mode.

Flashes when a program cannot be performed with some reasons.

VCR → DVD :

Appears during VCR to DVD duplication process.

VCR ← DVD :

Appears during DVD to VCR duplication process.

3. Recording speed

Indicates the recording speed of the disc or a videotape.

4. Title/Track and Chapter mark

T : Appears when indicating a title/track number.

C : Appears when indicating a chapter number.

5. Displays the following

- Played-back time / remaining time
- Current title / chapter / track number
- Recording time
- Clock
- Channel number
- VCR tape counter
- Remaining time for a one-touch Timer Recording

6. PM : Appears in the afternoon with the clock display.

Display message



Appears when the disc tray is opening.



Appears when a disc is loaded on the disc tray.



Appears when the disc tray is closing.



Appears when data is being recorded on a disc.

Connections

Connection to a TV

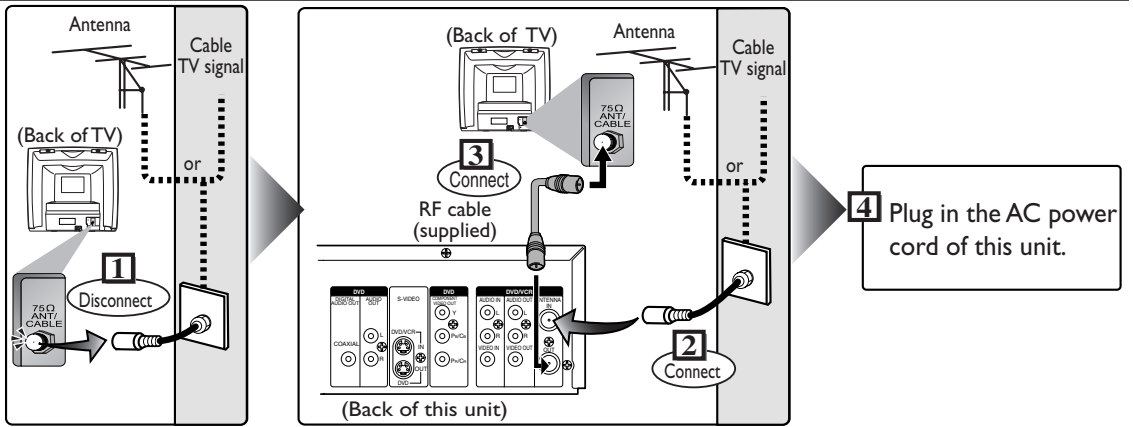

Choose one of the following connections, depending on the capabilities of the equipment you possess.

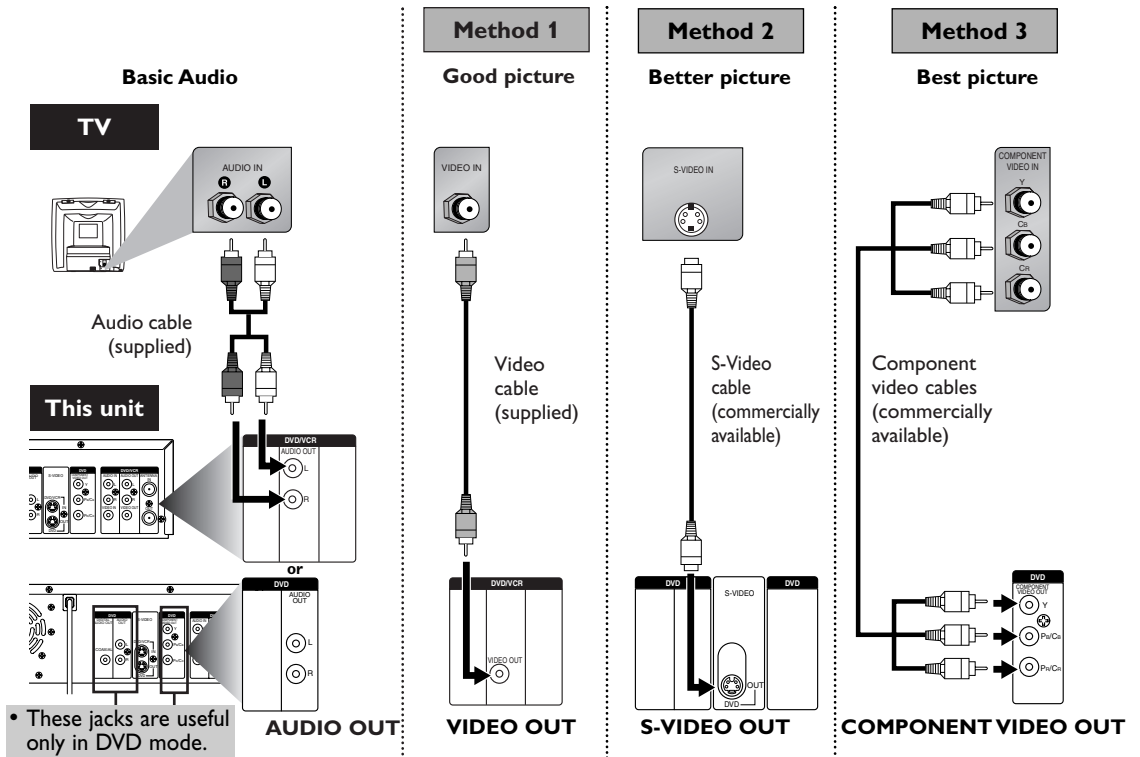

Note

- Connect this unit directly to the TV. If the A/V cables are connected to a VCR, pictures may be distorted due to the copy protection system.
- Method 2 and method 3 are only useful in DVD mode.

Connections

After you have completed connections

- Switch the input selector on your TV to an appropriate external input channel (usually near channel 0). Press a button on the TV's original remote control that selects an external input channel until the DVD recorder's picture appears. Check your TV owner's manual for details.

Input Mode Names for Common TV Brands (Example)

Admiral	AUX	Panasonic	TV/VIDEO
Curtis Mathis	LINE1, LINE2, 00, 90, 91, 92, 93	RCA	INPUT, TV/VCR, 00, 90, 91, 92, 93
GE	INPUT, TV/VCR, 00, 90, 91, 92, 93	Samsung	TV/VIDEO
Hitachi	INPUT, AUX	Sanyo	VIDEO
JVC	A/V CHANNEL, INPUT1, SVIDEO, INPUT2	Sharp	00
Kenwood	AUX	Sony	VIDEO1, VIDEO2, VIDEO3
LXI-Series	00	Toshiba	TV/GAME
Magnavox	AUX CHANNEL	Zenith	00

Connection to a cable box or satellite box

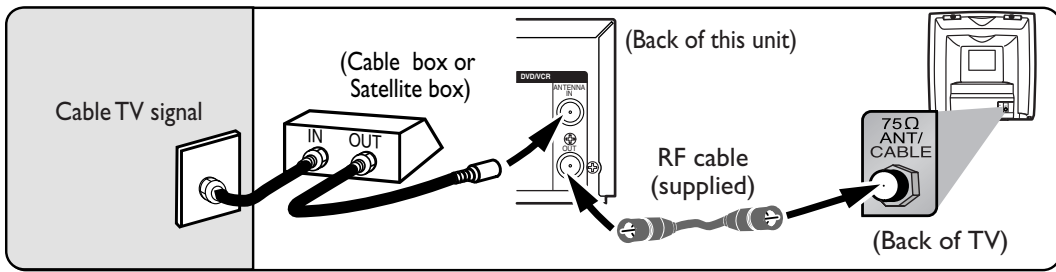

This connection allows you to view or record a scrambled channel. With this connection, channels cannot be changed on this unit. You can view or record **ONLY** the channels you have selected on the cable box or the satellite box.

- While you are recording, only the recorded channel can be viewed.

To select channels of the cable box or satellite box

- 1) Turn on this unit by pressing [**POWER**]. The "POWER" indicator on the front panel will appear. Then, press [**CHANNEL ▼ / ▲**] to select channel 3 or 4 (the same channel as the output channel of the cable box or satellite box).
 - If noise appears on the TV screen, press [**VIDEO/TV**] on the remote control.
 - If you use the channel 4, you will need to change this unit's RF output to channel 4. Refer to "RF output switch" on page 81.
- 2) At the TV, select channel 3 or 4 (the same channel as you have selected at step 1).
- 3) At the cable box or satellite box, select the channel you want to view or record.

Note to the Cable TV System Installer :

This reminder is provided to call the Cable TV system installer's attention to Article 820-40 of the National Electrical Code, which provides guidelines for proper grounding - in particular, specifying that the cable ground shall be connected to the grounding system of the building, as close to the point of cable entry as possible.

Connections

Connection to an Audio System

- When you change the connections, all devices should be turned off.
- Refer to the operation manual accompanying external devices for more information.

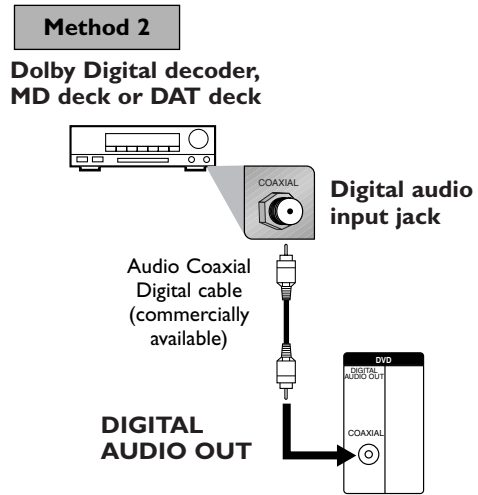
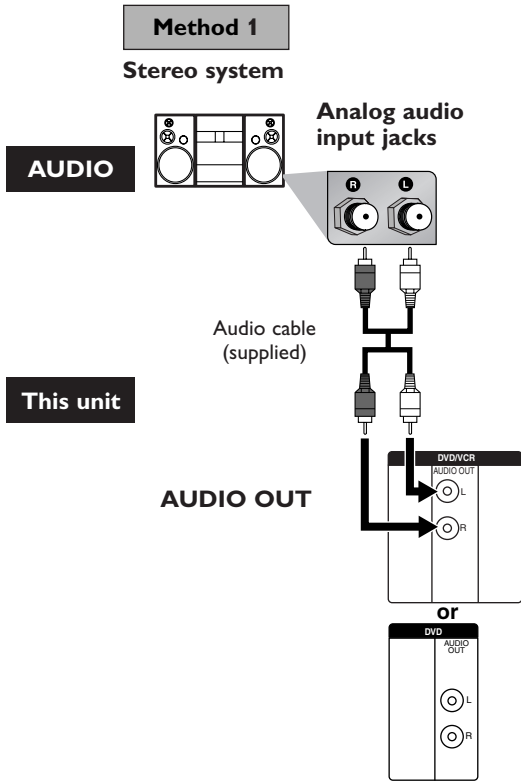

Connection	Setting	Setting >Playback >Digital Out >	
		PCM	Dolby Digital
If output is Dolby Digital encoded audio, connect to a Dolby Digital decoder.		-	Stream
Unless connected to a Dolby Digital decoder.		-	PCM
Connecting to an MD deck or DAT deck.		-	PCM

* To complete these settings, refer to pages 71-73.

Note

- By connecting this unit to a Multi-channel Dolby Digital decoder, you can enjoy high-quality Dolby Digital 5.1 channel surround sound as heard in the movie theaters.
- The audio source on a disc in a Dolby Digital 5.1 channel surround format cannot be recorded as digital sound by an MD or DAT deck.
- Playing back a DVD using incorrect settings may generate noise distortion and may also damage the speakers.

Getting started

Easy DVD recording

The following will help you to understand easily how to record to DVD discs.

Note:

Make sure batteries are in the remote control and you have connected this unit and the TV correctly.

Step 1: Choose a disc type

There are several types of recordable DVD discs to choose from. Choose a recordable DVD disc type based on your playback/recording/editing needs. See "DVD disc types" at the bottom of this page for more information on the differences among various compatible media.

This DVD recorder can record on the following type of discs.

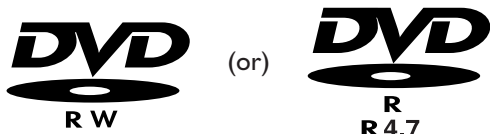

For example, when you want to record repeatedly on the same disc or when you want to edit the disc after recording, select the rewritable DVD-RW type disc.

When you want to save recordings without any alteration, a non-rewritable DVD-R can be your choice.

Step 2: Insert a blank disc

Remote Control

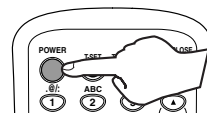

1 Turn on the unit

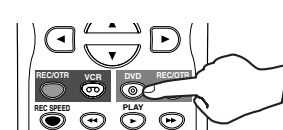

2 Select the DVD mode

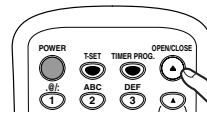

3 Open the disc tray

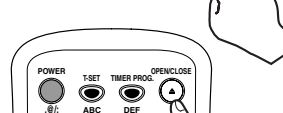

4 Open the disc tray

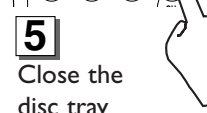

5 Close the disc tray

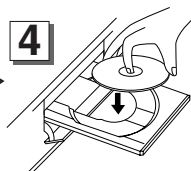

This operation may take a while to be recognized.

DVD disc types

☆☆☆ : Most suitable. ☆☆ : Can be used. ☆ : Some functions are limited. — : Cannot be used.

You want to	DVD-RW VR	DVD-RW Video	DVD-R
Record TV programs	☆☆☆	☆☆☆	☆☆
Reuse by deleting unwanted contents	☆☆☆	☆☆	—
Edit recorded contents	☆☆☆	☆	☆
Edit/Record from connected equipment	☆☆☆	☆☆☆	☆☆☆
Copy discs for distribution	☆☆ ^{*1}	☆☆☆	☆☆☆
Play on other DVD equipment	☆☆ ^{*1}	☆☆☆	☆☆☆

Features	DVD-RW VR	DVD-RW Video	DVD-R
Recording			
Rewritable?	Yes	Yes	No
Can create chapters at fixed intervals (auto.)	Yes	Yes	Yes
Can create chapters wherever you like (manual)	Yes	No	No
Can record 16:9 size pictures	Yes	Yes	Yes
Can record Copy-Once programs	Yes	No	No
Editing			
Can perform basic edit functions	Yes	Yes	Yes
Can perform advanced edit functions (Playlist edit)	Yes	No	No

^{*1} DVD-RW (VR mode) can only be played on DVD equipment that is VR compatible.

Note:
For details of the above functions and implied restrictions, see the explanations inside the manual.

Format the disc

When inserting a disc that has already been recorded on, you can delete those contents by formatting that disc.

Formatting is only necessary to prepare disc previously recorded on for recording.

Details are on pages 27-28.

When you format a disc, the entire contents on that disc will be erased.

- The unit automatically starts initializing when a brand new disc is inserted.

Getting started

Easy DVD recording (Cont'd)

Step 3: Select the Recording speed

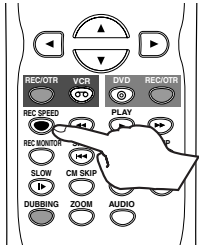

Step 4: Select the desired channel

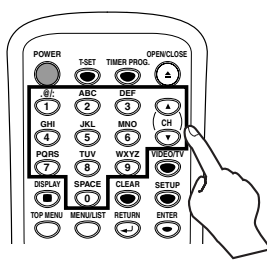

Step 5: Record to DVD discs

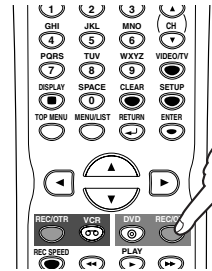

Hint 1: Play the recorded contents

You can select the title you want to play back from a displayed menu, and immediately start to play back. Recorded contents are easily accessible, with simple procedure of choosing a title on a chapter on the menu screen.

What are titles and chapters?

The contents of a DVD disc are generally divided into titles. Titles may be further divided into chapters.

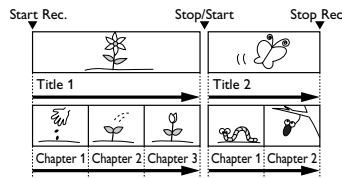

Hint 2: Edit the recorded disc

You will find editing discs is easy. This unit offers convenient editing functions which are possible only with DVD-RW/R discs.

Title list offers the following editing functions.

- Putting names on titles
- Setting pictures for thumbnails
- Setting/clearing chapter markers
- Deleting parts of titles or scenes

(Possible editing functions depend on the recording format and editing method.)

Original and Playlist (VR mode)

You can edit the contents on a Playlist without changing the original recordings. A Playlist does not take up much disc space.

What "Original" or "Playlist" is for?

Throughout this manual, you will find *Original* and *Playlist* to refer to the original content and the edited version.

- **Original** content refers to what's originally recorded on the disc.
- **Playlist** content refers to the edited version of the original content.

Finalizing a Disc

- You need to record in video mode and finalize the disc to play it back on other players.
- Once you finalize a disc recorded in video mode, you cannot record or edit any information on the disc.
- Discs recorded in VR mode can still be edited after finalization.

Step 6: Stop the Record

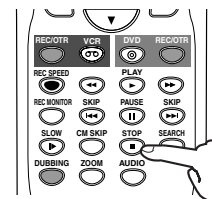

(Appears only in the VR mode)

This operation may take a while to be completed.

Getting started

Channel setting

Right after the purchase of the unit and whenever you move to a new area, we recommend to program available channels in your area using "Auto Preset" in the Channel Preset of the Setting menu.

Getting channels automatically

1
Press [POWER].

2
Turn on the TV. Select the input to which the unit is connected.

Refer to the table on page 15.

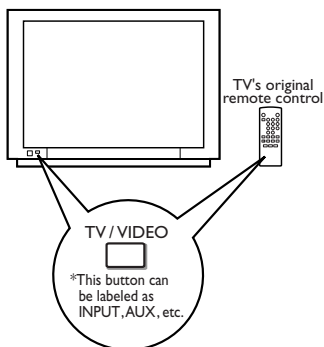

3
Press [SETUP].
Easy Setting Menu or Advanced Setting Menu will appear.

4
Using [▲ / ▼], select "Channel". Press [ENTER].
Channel menu will appear.

5
Using [▲ / ▼], select "Auto Preset". Press [ENTER].
The unit will start getting channels available in your area.

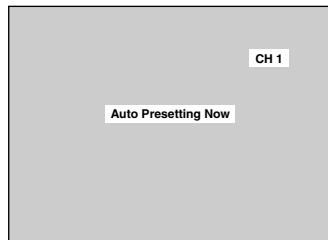

Wait for several minutes to finish channel scanning.

6
Press [SETUP] to exit.
• [CHANNEL ▼ / ▲] or [CH ▼ / ▲] will switch among the memorized channels.

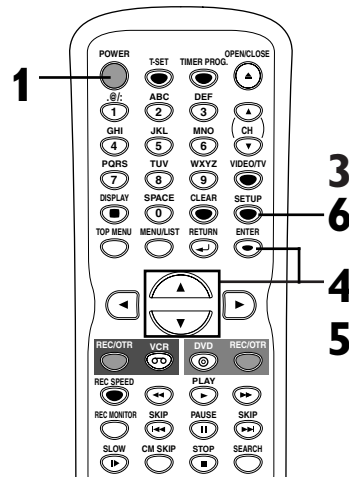

To select a channel

You can select a channel by directly entering channel number using the **Number buttons** on the remote control.

Notes for using the Number buttons:

- When selecting cable channels which are larger than 99, enter channel numbers as a three-digit number. (For example: 117, press [1], [1], [7].)
- You must precede single-digit channel numbers with a zero (For example: 02, 03, 04 and so on).
- You can select the line input mode ("L1" or "L2"). To select "L1" by pressing [0], [0], [1]. To select "L2" by pressing [0], [0], [2]. Details are on page 35.

Note

- You cannot change the channel while one of the functions on the unit (VCR or DVD) is in the recording, OTR or Timer Recording mode.
- **If the auto presetting is cancelled during presetting, some of the channels not yet preset may not be received.**
- The selection will depend on how you receive the TV channels.

To cancel the auto presetting during scanning:

Press [RETURN ↵] or [SETUP] to cancel.

Getting started

Channel setting (cont'd)

Adding/deleting channels

The channels you no longer receive or seldom watch can be deleted from the memory. You can also add channels manually into memory.

1

Press [SETUP].

Easy Setting Menu or Advanced Setting Menu will appear.

2

Using [▲ / ▼], select "Channel". Press [ENTER].

Channel menu will appear.

3

Using [▲ / ▼], select "Manual Preset". Press [ENTER].

Manual Preset menu will appear.

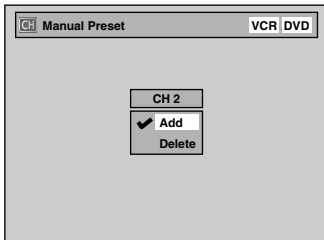

4

Select the channel number to add or delete.

Press [◀] or CH [▼] to move to a smaller channel number.

Press [▶] or CH [▲] to move to a larger channel number.

- Use [◀ / ▶] to move through the channels one by one, including the ones not in the channel memory, while use [CH ▲ / ▼] to move through the channels only in the channel memory.

Press the **Number buttons** to select a channel number directly.

5

Using [▲ / ▼], select "Add" or "Delete". Press [ENTER].

The channel number will be added or deleted from the channel memory. Then, the next channel number will appear so that you can continue adding or deleting channels.

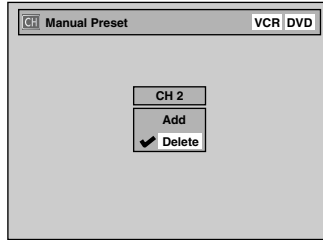

6

Press [SETUP] to exit.

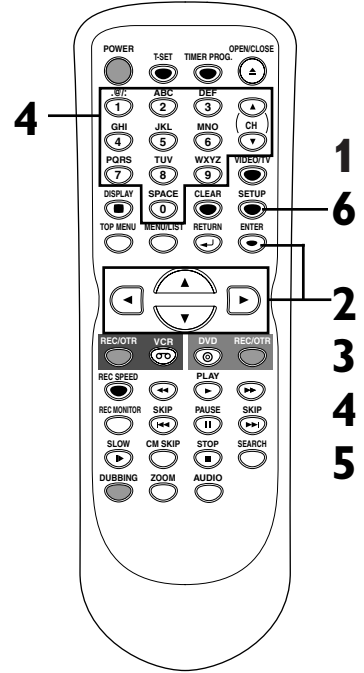

Getting started

Selecting the TV stereo or SAP

You can select an audio channel to output from TV.

1

Press **[SETUP]**.

Easy Setting Menu or Advanced Setting Menu will appear.

If Advanced Setting Menu is displayed, proceed to step 3.

2

Using **[▲ / ▼]**, select “Advanced Setting Menu”.

Press **[ENTER]**.

Advanced Setting Menu will appear.

3

Using **[▲ / ▼]**, select “Channel”. Press **[ENTER]**.

Channel menu will appear.

4

Using **[▲ / ▼]**, select “TV Audio Select”. Press **[ENTER]**.

Option window will appear.

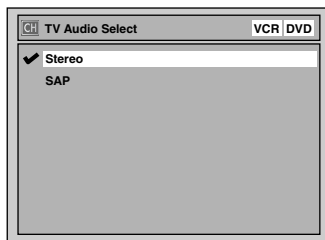

The default is set as “Stereo”.

5

Using **[▲ / ▼]**, select “Stereo” or “SAP”. Press **[ENTER]**.

Stereo:

Outputs main-audio.

SAP (Secondary Audio Program):

Outputs sub-audio.

Refer to the item in “Glossary” on page 82 for more information.

6

Press **[SETUP]** to exit.

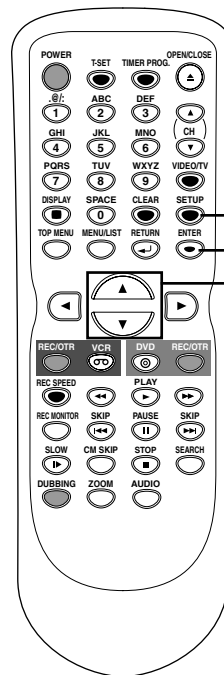

Notes on TV channel audio

- If you want to record a TV program available in second audio or stereo on a DVD-RW/R or videotape, you have to select either Stereo or SAP in the Channel Preset screen beforehand. Refer to the following table to check an appropriate setting.

Selected audio	Broadcast audio	Disc (Videotape) recording	Audio output
Stereo	STEREO+SAP	STEREO	STEREO
	STEREO	STEREO	STEREO
	MONO+SAP	MONO	MONO
	MONO	MONO	MONO
SAP	STEREO+SAP	SAP	SAP
	STEREO	STEREO	STEREO
	MONO+SAP	SAP	SAP
	MONO	MONO	MONO

- You can only play back the disc in second audio if a TV program is available in second audio and you set “TV Audio Select” to “SAP”.

Getting started

Setting the clock

Set the clock before you try the Timer Recording. If Public Broadcasting Service (PBS) is available in your area, follow the Auto Clock Setting below. If not, follow the Manual Clock Setting on page 23.

Auto Clock Setting

Make sure:

- The antenna/cable TV connections are correct.
- If this unit is connected to a Cable Box or Satellite Box, select the local PBS station to set the clock automatically.

1

Press [SETUP].

Easy Setting Menu or Advanced Setting Menu will appear. If Advanced Setting Menu is displayed, proceed to step 3.

2

Using [▲ / ▼], select "Advanced Setting Menu". Press [ENTER].

Advanced Setting Menu will appear.

3

Using [▲ / ▼], select "Clock". Press [ENTER].

Clock menu will appear.

4

Using [▲ / ▼], select "Auto Clock Setting". Press [ENTER].

Option window will appear.

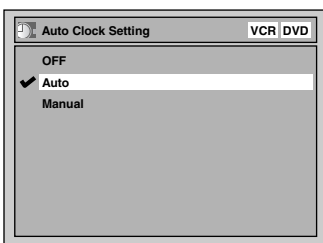

The default setting is "Auto".

5

• If you do not know the PBS channel number in your area:

Using [▲ / ▼], select "Auto". Press [ENTER].

The setting will be activated.

• If you know the PBS channel number in your area:

Using [▲ / ▼], select "Manual". Press [ENTER].

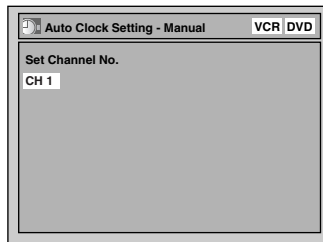

Using the Number buttons or [▲ / ▼], enter the PBS channel number. Press [ENTER].

The setting will be activated.

• If you want to set the clock manually and cancel the auto clock setting:

Using [▲ / ▼], select "OFF". Press [ENTER].

The auto clock setting will be canceled.

6

Press [SETUP] to exit.

7

Press [POWER] to turn off the unit.

This unit will search for the clock time only when the power is off. Leave it off for several minutes to give this unit time to set the clock on the display of the front panel.

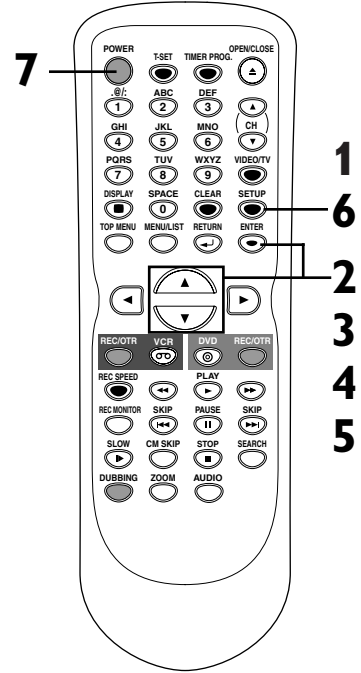

Note

- The clock may set itself automatically after you connect the antenna/cable signal to this unit and plug in the power cord. In this case, the current time will appear on the front panel display.
- If the current time is not displayed or the displayed clock time is not correct, set the clock manually.

Getting started

Setting the clock (cont'd)

Manual Clock Setting

1

Press [SETUP].

Easy Setting Menu or Advanced Setting Menu will appear.

2

Using [▲ / ▼], select "Clock". Press [ENTER].

When entering from Advanced Setting Menu, Clock menu will appear.

3

When entering from Advanced Setting Menu, using [▲ / ▼], select "Clock Setting". Press [ENTER]. A clock setting window will appear.

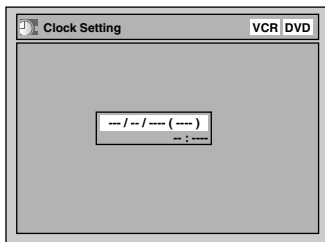

Press [ENTER] again.
Default date will appear.

4

Using [▲ / ▼], enter the date (month / day / year).

Use [◀ / ▶] to move the cursor.

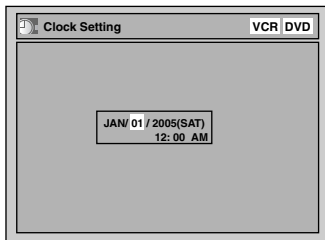

5

Using [▲ / ▼], enter the time (hour / minute).

Use [◀ / ▶] to move the cursor.

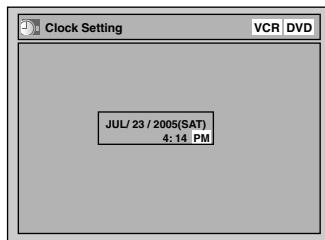

6

Use [▲ / ▼] to select AM or PM. Press [ENTER].

Clock menu will appear, then the settings will be activated. Although seconds are not displayed, they will be counted from zero.

7

Press [SETUP] to exit.

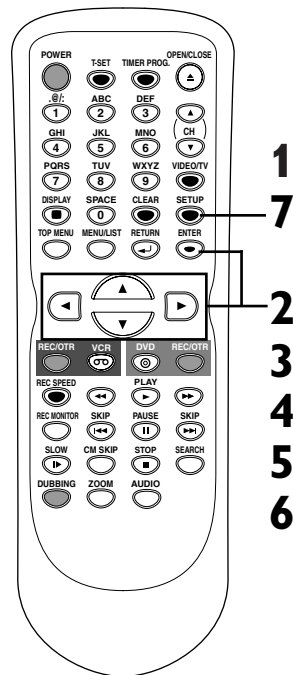

Note

- Your clock setting will be lost if either there is a power failure or this unit has been unplugged for more than 30 seconds.

Getting started

Setting the clock (cont'd)

Setting the daylight saving time

When Daylight Saving Time is ON, the clock will automatically move forward one hour on the first Sunday in April and move back one hour on the last Sunday in October.

1

Press [SETUP].

Easy Setting Menu or Advanced Setting Menu will appear. If Advanced Setting Menu is displayed, proceed to step 3.

2

Using [▲ / ▼], select "Advanced Setting Menu".

Press [ENTER].

Advanced Setting Menu will appear.

3

Using [▲ / ▼], select "Clock". Press [ENTER].

Clock menu will appear.

4

Using [▲ / ▼], select "Daylight Saving Time". Press [ENTER].

Option window will appear.

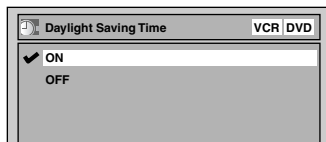

5

Using [▲ / ▼], select "ON" or "OFF". Press [ENTER].

Choose "ON" if you are currently observing the daylight saving time.

6

Press [SETUP] to exit.

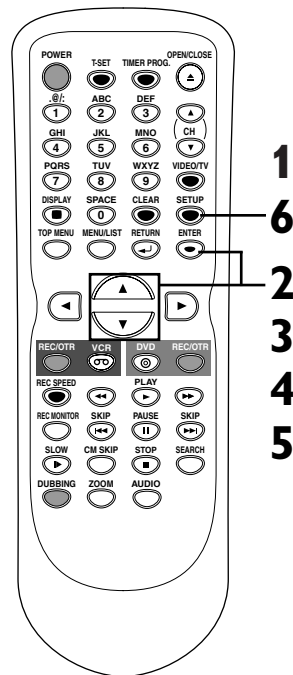

Selecting the TV aspect ratio

You can select the TV aspect ratio to match the formats of what you are playing back on the unit and your TV screen (4:3 standard or 16:9 widescreen TV).

The default is set as "4:3 Letter Box".

1

Press [SETUP].

Easy Setting Menu or Advanced Setting Menu will appear. If Advanced Setting Menu is displayed, proceed to step 3.

2

Using [▲ / ▼], select "Advanced Setting Menu".

Press [ENTER].

Advanced Setting Menu will appear.

3

Using [▲ / ▼], select "Playback". Press [ENTER].

Playback menu will appear.

4

Using [▲ / ▼], select "TV Aspect". Press [ENTER].

Option window will appear.

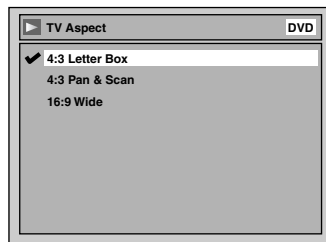

Refer to the Note on this page.

5

Using [▲ / ▼], select a desired option. Press [ENTER].

6

Press [SETUP] to exit.

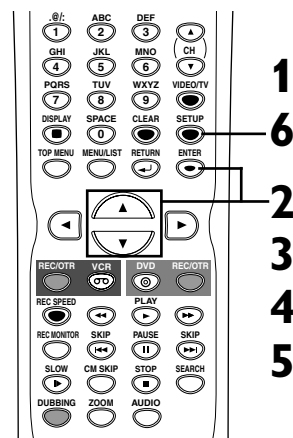

Note

If you have a standard TV:

Select "4:3 Letter Box" for full length picture with black bars on the top and bottom of the screen. Select "4:3 Pan & Scan" for a full height picture with both sides trimmed.

If you have a widescreen TV:



Select "16:9 Wide".

Recording

Information on DVD recording

Information

This unit can record on DVD-R and DVD-RW discs. DVD-R discs allow you to record programs only once, and the recorded contents cannot be erased. DVD-RW discs allow you to record programs repeatedly, and the recorded contents can be erased. You can record programs on DVD-R discs only in Video mode, while recording format for DVD-RW discs can be either Video mode or VR mode.

Logo	Attributes
	8cm/12cm, single-sided, single layer disc Approx. max. recording time (SEP mode): 600 minutes (4.7GB) (for 12cm) 180 minutes (1.4GB) (for 8cm)
	8cm/12cm, single-sided, single layer disc Approx. max. recording time (SEP mode): 600 minutes (4.7GB) (for 12cm) 180 minutes (1.4GB) (for 8cm)

Recordable disc







- Discs which can be used with this recorder:
DVD-R: up to 16x (4x or 8x disc is recommended)
DVD-RW: 2x and 4x (2x disc is recommended)
- Discs tested and proven to be compatible with this recorder:
MAXELL DVD-R TDK DVD-RW 2x
JVC DVD-RW 4x MITSUBISHI DVD-R 8x
- About Video mode and VR (Video Recording) mode

Video mode is the same recording format as DVD-Video discs purchased locally and played back on most DVD players.

To play back the disc on other DVD players, you will need to finalize the disc (see page 36). Before finalization, you can record additionally or edit disc with this unit.

VR (Video Recording) mode is a basic recording format for DVD-RW. You can edit, record and delete repeatedly.

DVD players with  are capable of playing DVD-RW recorded in VR mode.

Disc type	Disc format	Functions
	Video mode 	Playback, limited recording, limited editing
	VR mode 	Playback, recording, Original/Playlist editing
	Video mode 	Playback, limited recording, limited editing

Recording speed

You can select a recording speed among 6 options, and the recording time will depend on the recording speed you select as follows.

Disc Size	Recording speed	Recording time *	Video/Sound Quality
8cm Disc	XP (1H)	18 min	☆☆☆☆☆☆
	SP (2H)	36 min	☆☆☆☆☆☆
	LP (4H)	72 min	☆☆☆☆
	EP (6H)	108 min	☆☆☆
	SLP (8H)	144 min	☆☆
	SEP (10H)	180 min	☆
12 cm Disc	XP (1H)	60 min	☆☆☆☆☆☆
	SP (2H)	120 min	☆☆☆☆☆☆
	LP (4H)	240 min	☆☆☆☆
	EP (6H)	360 min	☆☆☆
	SLP (8H)	480 min	☆☆
	SEP (10H)	600 min	☆

* The recording time are estimates and actual recording time may differ.

* The audio and video quality is getting poorer as the recording time becomes longer.

* Each time [REC SPEED] is press, allowed recording time will be displayed.

Note

- This recorder cannot record on CD-RW or CD-R discs.
- DVD-RW/R and CD-RW/R discs recorded on a personal computer or a DVD or CD recorder may not be played back if the disc is damaged or dirty or if there is dirt or condensation on the player's lens.
- If you record on a disc using a personal computer, there are cases in which it may not be played back because of the settings of the application software used to create the disc, even if it is recorded in a compatible format. (Check with the software publisher for more detailed information.)
- Discs recorded in Video mode on this unit cannot record additionally using other DVD recorders.
- A DVD-RW disc formatted with this unit cannot be used on other DVD recorders.
- Since the recording is made by the variable bit rate (VBR) method, the actual remaining time for recording may be a little bit shorter than the remaining time displayed on the OSD, depending on the picture you are recording.

Recording

Information on DVD recording (cont'd)

Restrictions on recording

You cannot record copy-protected discs or tapes using this unit. Copy-protected material includes DVD-Video discs and some satellite broadcasts. If copy-protected material is encountered during a recording, recording will be paused or stop automatically and an error message will be displayed onscreen.

Material that is “copy-once only” can only be recorded using a DVD-RW disc in VR mode with CPRM (see below).



When recording a TV broadcast or through an external input, you can display copy control information on screen.

What is “CPRM”?

This is a format used to record copy-once programs. By recording coded data on the area of DVD discs that ordinary writing software cannot write, it prevents copy-once programs from being recorded repeatedly on different media. This unit is CPRM compatible, which means that you can record copy-once broadcast programs, but then you cannot make a copy of those recordings. CPRM recordings can only be made on DVD-RW discs formatted in VR mode, and CPRM recordings can only be played back on DVD players that are compatible with CPRM.

Information on copy control

Some satellite broadcasts include copy-protected information. For their recording, refer to the following.

Disc type / format	Copy-free	Copy-once	Copy-prohibited
 ver.1.1,1.2 ver.1.1,1.2 CPRM compatible	☆	—	—
	☆	☆	—
 ver.1.1,1.2 ver.1.1,1.2 CPRM compatible	☆	—	—
	☆	—	—
 ver.2.0	☆	—	—

☆ Recordable

— Not Recordable

Making discs playable on other DVD player (Finalize)

After recording, you must finalize the disc in order to play on other units. (Refer to page 36.)

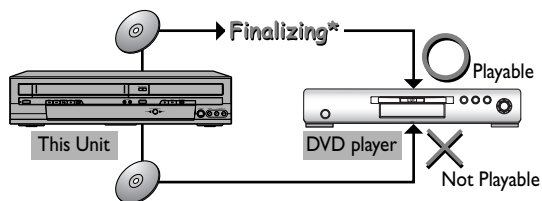

* You cannot finalize discs recorded in other DVD recorders.

After finalizing:

- After DVD-R discs are finalized :
 - A title menu is created automatically.
 - Undo finalizing is not possible.
 - Additional recording or editing is not possible.
- After DVD-RW (Video mode) discs are finalized :
 - A title menu is created automatically.
 - Undo finalizing is possible. (Refer to page 36.)
 - Additional recording or editing is possible if you undo finalize. (Refer to page 36.)
- After DVD-RW (VR mode) is finalized :
 - A title menu is not created.
 - Undo finalizing is possible. (Refer to page 36.)
 - Additional recording or editing is possible even without undo finalizing.

Recording

Formatting a disc

Choosing the recording format of a blank disc



When inserting a blank disc, the unit starts to initialize it automatically.

After that, you can record on the disc with a recording format selected in the Setting menu. You can set specific time interval for chapter marks.

1

Press **[SETUP]**.

Easy Setting Menu or Advanced Setting Menu will appear.

If Easy Setting Menu is displayed, proceed to step 3.

2

(Advanced Setting Menu only)

Using **[▲ / ▼]**, select **“Recording”**. Press **[ENTER]**.

Recording menu will appear.

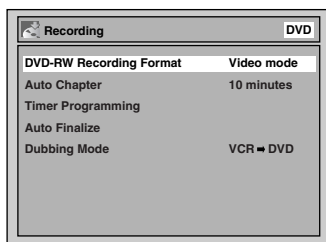

3

Using **[▲ / ▼]**, select **“DVD-RW Recording Format”**.

Press **[ENTER]**.

Option window will appear.

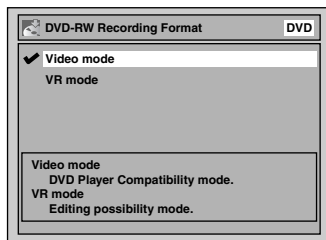

The default is set as “Video mode”.

4

Using **[▲ / ▼]**, select **“Video mode”** or **“VR mode”**. Press **[ENTER]**.

The recording format will be set.

5

(Advanced Setting Menu only)

Using **[▲ / ▼]**, select **“Auto Chapter”**. Press **[ENTER]**.

Option window will appear.

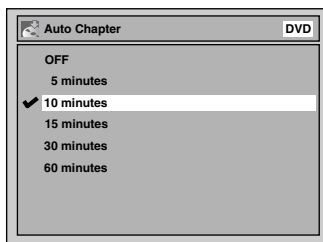

The default is set as “10 minutes”.

6

(Advanced Setting Menu only)

Using **[▲ / ▼]**, select a desired time option. Press **[ENTER]**.

Chapter marks will be put as you specified.

7

Press **[SETUP]** to exit.

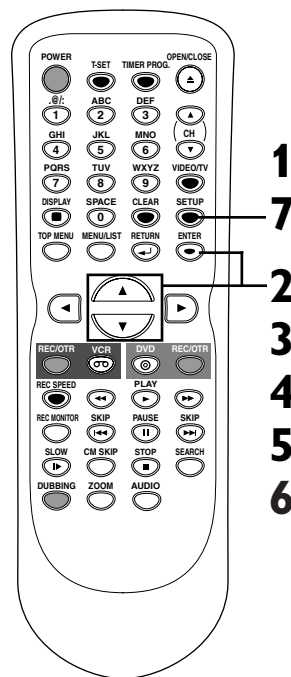

Note

- The recording format setting is effective only for DVD-RW discs. You cannot change the recording format for a DVD-R disc. DVD-R discs will always be in Video mode.
- You cannot mix two formats on one DVD-RW disc. When you load a disc once recorded before, the recording format cannot be changed even if you change it in the Setting menu.
- When inserting a blank DVD+RW or DVD+R disc, the error message (“Disc Error”) will appear. You cannot record on a DVD+RW/R. On this unit, DVD+RW and DVD+R are for playback only.
- Playlist will be created automatically when recording on DVD-RW in VR mode.
- In Video mode, Auto Chapter may not show up as you specified.
- A blank chapter may be created depending on the remaining time of the disc.

Recording

Formatting a disc (cont'd)

Reformatting a disc



Video mode is the default recording format for DVD-RW. You can change it to VR mode from the Setting Menu.

1

Press [SETUP].

Easy Setting Menu or Advanced Setting Menu will appear.

2

Using [▲ / ▼], select “Disc”. Press [ENTER].

Disc menu will appear.

3

Using [▲ / ▼], select “Format”. Press [ENTER].

Confirmation window will appear.

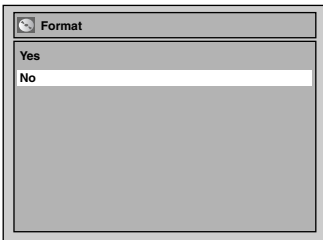

4

Using [▲ / ▼], select “Yes”. Press [ENTER].

Final confirmation window will appear.

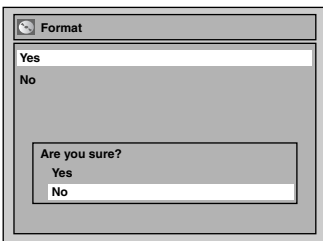

5

Using [▲ / ▼], select “Yes”. Press [ENTER].

Formatting will start.

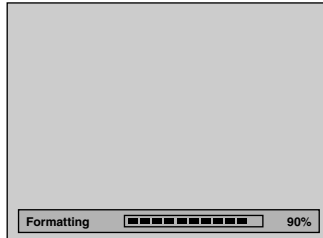

6

Formatting is complete.

100% will be indicated.

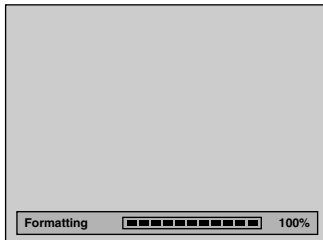

This operation may take a while to be completed.

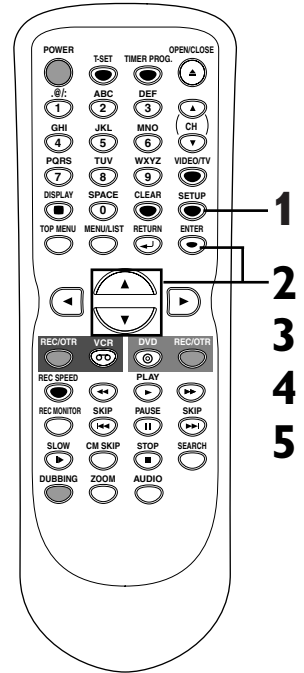

Note

- When you reformat the disc, all contents of the disc will be erased.
- If you want to cancel formatting at step 3 or 4, select “No”.
- A disc once formatted with this unit cannot be used on other DVD recorders.

Recording

Basic recording



Follow steps below to record TV programs.

First:

1

Turn on the unit. Load a recordable disc.

Make sure that the TV input is set on the unit.

This operation may take a while to be recognized.

2

Using [REC SPEED], select a recording speed.



Refer to "Recording speed" on page 25.

3

Make sure that the recording format is set to the desired mode.

Refer to "Formatting a disc" on pages 27-28.

When a DVD-RW disc is loaded:
You can choose Video mode or VR mode from the Setting menu.

"Video mode" has been selected as the default. Refer to "Choosing the recording format of a blank disc" on page 27.

When a DVD-R disc is loaded:
DVD-R discs will be always in Video mode.

4

Using [CH ▲ / ▼] or the Number buttons, select a desired channel to record.



5

Press [REC/OTR] (DVD) to start recording.

● mark will be displayed for 5 seconds.



Press [PAUSE II] to pause.
Press [REC/OTR] (DVD) (or [PAUSE II]) to resume.

6

Press [STOP ■] to stop recording.

This operation may take a while to be completed.

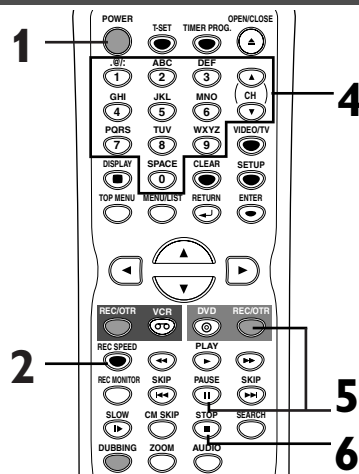

Note

- Recording starts immediately after you press [REC/OTR] (DVD) and continues until the disc is full or you stop recording.
- When the clock setting has not been made, the space for a date and time of title names in the Original or Playlist will be blank.
- When you record a TV program broadcasted in both Stereo and SAP-audio on a DVD-RW/R, you have to select the TV channel audio (Stereo or SAP) beforehand. Only the selected channel audio will be recorded. Refer to "Selecting the TV stereo or SAP" on page 21 for more details.
- You cannot change the recording speed during the REC pause mode.
- You can change channels during the REC pause mode.

Checking the recording picture and sound quality



You can confirm the recording picture and sound quality with the recording speed you have selected before attempting to record to a DVD disc.

First:

1

While in the stop or recording mode, press [REC MONITOR].

The TV program will be on the screen in the recording picture quality and the sound will be output in the recording sound quality with the recording speed you have selected.

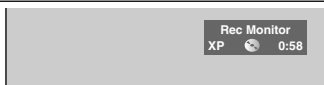

Press [REC SPEED] repeatedly to change the recording speed.

The recording speed will be changed as you press the button as shown below. Refer to "Recording speed" on page 25.

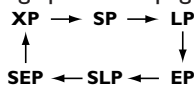

You cannot change the recording speed during recording.

2

Press [REC MONITOR] again to exit.

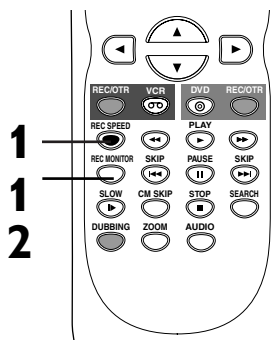

Note

- If you press [REC MONITOR] while receiving the bilingual broadcast, the sound to be recorded is output.

Recording

One-touch Timer Recording



This is a simple way to set the recording time in blocks of 30 minutes. Check that the disc has enough recordable space for the time you set.

After finishing the recording, the recorder automatically goes into standby.

First:

1
Turn on the unit and load a recordable disc.

Make sure that the TV input is set on the unit.

This operation may take a while to be recognized.

2
Using [REC SPEED], select a recording speed.

Refer to "Recording speed" on page 25.

3
Make sure that the recording format is set to the desired mode.

Refer to "Formatting a disc" on pages 27-28.

When a DVD-RW disc is loaded:

You can choose Video mode or VR mode from the Setting menu. "Video mode" has been selected as the default. Refer to page 27 "Choosing the recording format of a blank disc."

When a DVD-R disc is loaded:
DVD-R discs will always be in Video mode.

4
Using [CH ▲ / ▼] or the Number buttons, select a desired channel to record.

5
Press [REC/OTR] (DVD) repeatedly to select a desired recording time.

Recording time appears on the TV screen (30 minutes to 8 hours).
Recording will start.

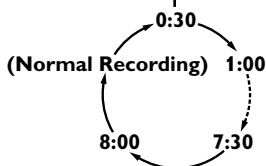
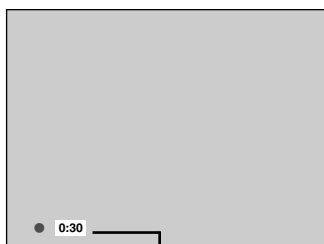

When the unit reaches the specified time, it will turn off automatically.

To change the recording time during the one-touch Timer Recording, press [REC/OTR] (DVD) repeatedly until the desired time appear.

To cancel the one-touch Timer Recording within the specified time, press [STOP ■].

This operation may take a while to be completed.

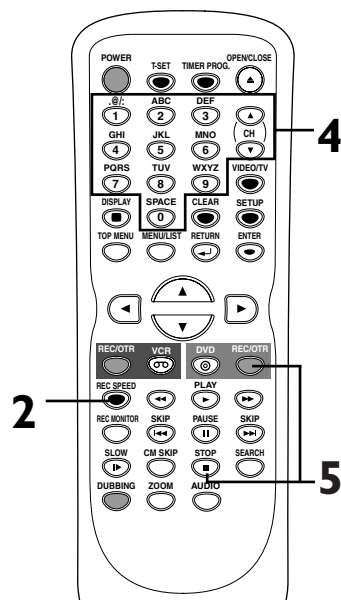

Note

- The remaining recording time will appear on the display panel during an one-touch Timer Recording. Press [DISPLAY] to see it on the TV screen.
- You cannot pause a one-touch Timer Recording.
- Unlike a Timer Recording, you can perform the following operations during a one-touch Timer Recording.
 - Turning off the power.
 - Using [REC/OTR] (DVD) and [STOP ■].
- The unit will be turned off automatically under the following conditions.
 - No space remained on the disc.
 - When a power failure occurs.
- If OTR is finished in DVD during playback or REC mode in VCR, the DVD will be in STOP mode and the VCR keeps the current mode.
- When OTR is finished and the power is turned off, the unit will switch to the standby mode automatically if a Timer Recording has been programmed. Press [T-SET] to cancel the standby mode for using the unit continuously.

Recording

Timer Recording



You can program the unit to record up to 8 programs within a month in advance. Daily or weekly program recordings are also available.

- Be sure to set the clock before programming a timer recording.
- Insert a recordable disc or a videotape with a record tab.

1

Press **[SETUP]**.

Easy Setting Menu or Advanced Setting Menu will appear. If Easy Setting Menu is displayed, proceed to step 3.

2 (Advanced Setting Menu only)

Using **[▲ / ▼]**, select “Recording”. Press **[ENTER]**. Recording menu will appear.

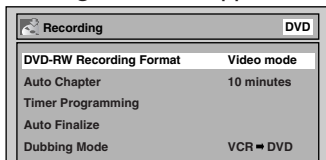

3

Using **[▲ / ▼]**, select “Timer Programming”. Press **[ENTER]**. Timer Programming list will appear.

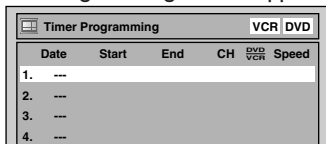

4

Using **[▲ / ▼]**, select a program number. Press **[ENTER]**.

5

Using **[▲ / ▼]**, enter the date. Press **[▶]**.

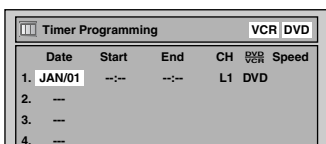

When pressing **[▼]** at the current date, Timer Recording mode will change as follows.

e.g. January 1st

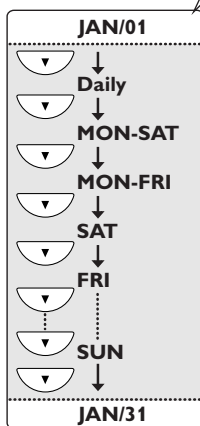

6

Using **[▲ / ▼]**, enter start and end time. Press **[▶]**.

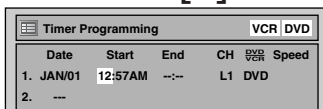

7

Using **[▲ / ▼]**, select the channel number. Press **[▶]**.

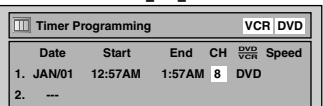

To record from external input, select L1 or L2.

8

Using **[▲ / ▼]**, select a recording media. Press **[▶]**.

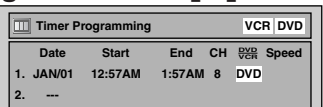

- To record on to a videotape, select VCR.
- To record on to a disc, select DVD.

9

Using **[▲ / ▼]**, select a recording speed.

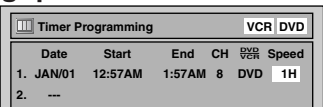

Refer to “Recording speed” on page 25 for DVD or page 75 for VCR.

You can choose the timer programming menu by pressing **[TIMER PROG.]**. In this case, continue with step 4.

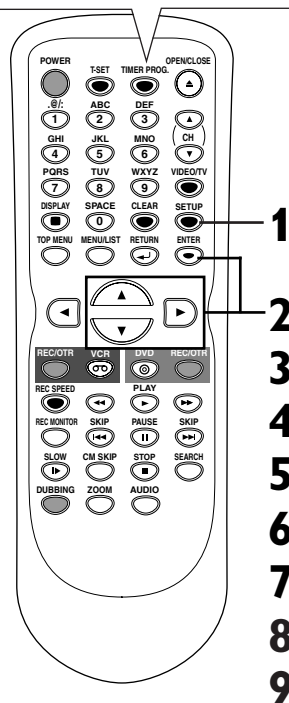

Note

- **If you have not set the clock yet:** A clock setting window will appear after step 3. Continue with step 4 in “Auto Clock Setting” on page 22 or “Manual Clock Setting” on page 23 before setting a timer programming.
- Use **[◀ / ▶]** to move the cursor to the left and the right on the timer programming menu.
- After step 11, you can use the other component (VCR or DVD) which is not currently programmed by turning the power on. Note that the programmed device will start to capture the selected channel 2 minutes before the start time and at the moment, if the other device still stays in recording, recording pause or OTR mode turning a different channel, the current mode will be canceled and you cannot change the channel. When both devices capture the same channel, the current mode continues to function.

Recording

Timer Recording (cont'd)

10

Press [ENTER] when information is entered.

Your program setting will be stored.

- To set another program, repeat steps 4 to 10.
- To exit, press [SETUP].
- When programs are overlapped, "Overlap" and the overlapped program numbers will appear on the display.

11

Press [T-SET].

The unit will be set in the timer standby mode.

Ⓢ indicator will appear on the front display.

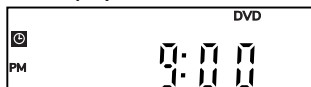

- "VCR" will appear if VCR Timer Recordings have been set.

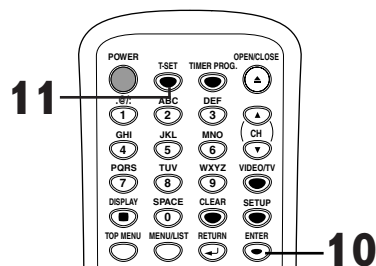

Checking, canceling or correcting the timer programming information

1

Press [T-SET].

Ⓢ indicator disappears from the front display.

2

Press [TIMER PROG.].

Timer Programming list will appear.

Timer Programming						VCR DVD
Date	Start	End	CH		Speed	
1.	---					
2.	---					
3.	---					
4.	---					

3

Check the information on the list you will need.

4

To clear the timer programming: Using [▲ / ▼], select the program. Press [CLEAR].

To correct the timer programming:

Using [▲ / ▼], select the program. Press [ENTER].

Next, correct the timer programming using [▲ / ▼ / ◀ / ▶]. Finally, press [ENTER] again.

5

Press [TIMER PROG.] to exit.

6

Press [T-SET] to return to the timer standby mode.

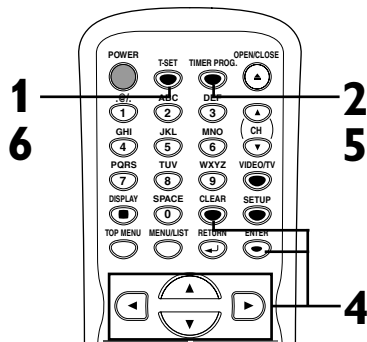

Note

- Press [TIMER PROG.] to confirm the timer programming.
- When the Timer Recording is in progress, that program will be highlighted in red. In this case, you cannot select any other program for correction or add any new programs.
- You cannot select any programs for correction or add new programs while the unit is in timer standby mode.
- The unit will be turned on automatically before the recording time.

To stop the Timer Recording in progress

Press [STOP ■] to stop the disc recording or [STOP ■ / EJECT ▲] to stop the videotape recording on the front panel of the main unit. [STOP ■] on the remote control is not effective.

If the timer program did not complete correctly, the error number appears on the timer programming list.

Timer Programming						VCR DVD
Date	Start	End	CH		Speed	
* JAN/01	12:57AM	1:57AM	8	DVD	E22	
2.	---					
3.	---					
4.	---					
5.	---					
6.	---					
7.	---					
8.	---					

Each error number means:

- E1-22, E37-39 Recording error other than below
- E23-24 Unrecordable disc
- E25-28 Copy prohibited program
- E29 Disc protected
- E30 Disc full
- E31-32 Already 99 titles recorded
- E33 Already 999 chapters recorded
- E34 No space for Control information
- E35 PCA full

- E36 Already finalized Video format disc
- E40 Some portion has not been recorded because of program overlapping. Recording did not start at the start time. No Videotape is inserted. Videotape ran out during recording.
- E41 Power failed
- E42 No disc when recording

Press [CLEAR] to erase the selected program.

- A program with the error number is grayed out and asterisked on the timer programming list.
- Once the timer programming list with error indication is displayed, the program line(s) with error will be cleared only after the programs are cancelled and reset to the timer standby mode.

Recording

Timer Recording (cont'd)

Hints for Timer Recording

- If there is a power failure or this unit has been unplugged for more than 30 seconds, the clock setting and all timer settings will be lost.
- If a recordable disc is not on the tray or an unrecordable disc is on the tray, the DVD indicator on the front panel flashes and Timer recording cannot be performed. In some cases, the DVD indicator appears momentarily around the Timer starting time as the unit attempts to record. Please insert a recordable disc.
- If a videotape with a record tab is not in the cassette compartment or there is no videotape in the compartment, the VCR indicator on the front panel flashes and timer recording cannot be performed. Please insert a recordable videotape.
- If you press **[POWER]** and turn on the unit while either DVD or VCR is in timer standby mode, the  indicator lights off. In this case, you cannot change the mode between DVD and VCR. You cannot change any settings using **[SETUP]** or edit discs.
- After step 11 on page 32, you can turn on the power to use the side of the unit that is free from Timer Recording (either DVD or VCR) for another recording by pressing **[POWER]** during timer standby. During Timer Recording, press **[OUTPUT SELECT]** on the front panel, or **[DVD]** or **[VCR]** on the remote control. Note that you cannot change channels after Timer Recording started. You can use all recording/recording pause/OTR functions. However, the unit will begin receiving channel signals for Timer Recording 2 minutes before the programmed starting time. Unless the program that you are currently recording using the Timer Recording free side of the unit is on the same channel with the one programmed for Timer Recording, the unit prioritizes Timer Recording and the current recording will be automatically stopped. If the channels set for Timer recording and the current recording are same, the current recording will continue without interruption.
- If both DVD and VCR are timer programmed, you cannot use any functions for either unit during timer standby or Timer Recording. If you want to use functions other than recording under such condition, cancel Timer Recording by pressing **[T-SET]** during timer standby or stop recording by pressing **[STOP]** on the front panel during Timer Recording.
- When the starting and ending time are same, the recording will be set for 24 hours. When the disc reaches the end during the recording, the unit turns itself off. If you want to continue the recording, cancel timer standby by pressing **[T-SET]**, insert a new disc, and then press **[T-SET]** again. If you are recording on a tape, the unit automatically ejects the tape when it reaches the end. You can continue the recording by inserting a new tape.
- When the programmed starting and ending time are earlier than the current time, the setting will not be accepted and be cleared for redoing.
- If the starting time is earlier and the ending time is later than the current time, the recording will start right after you press **[T-SET]**.
- The Timer Recording cannot be performed in DVD and VCR at the same time. If you set two programming with the same channel and time in both units, the program with a lower program number will be recorded.

The priority of overlapped settings

This unit prioritizes recording as follows if the timer programmings are overlapped.
A Timer Recording of lower priority will be canceled, start from the middle or stop on the way.
Check the overlapped timer programmings and change the priority if necessary.

■ **A programming with a lower program number has priority**

When the starting time is same:

A program with a lower program number (PROG. 1) has priority.

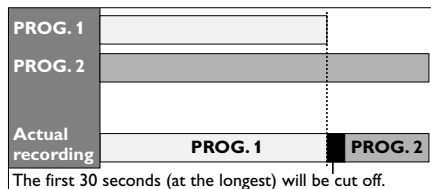

When some programming have been made around the end time of the program currently being recorded:

A program with a lower program number (PROG. 2) has priority.

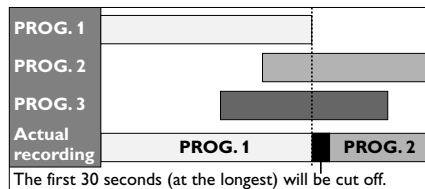

■ **When the recording time is partially overlapped:**
PROG. 1 will start after PROG. 2 recording is completed.

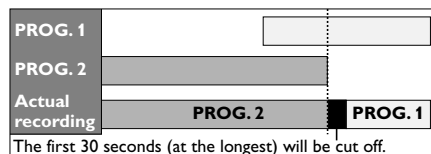

■ **When the recording time is entirely overlapped:**
PROG. 1 will not be recorded at all.

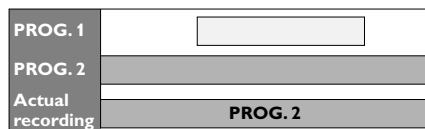

Note for DVD recording

- When the recording time of two programs are overlapped, or the End time of a program and the Start time of another are the same, the first 30 seconds (at the longest) of the subsequent program will be cut off.
- If the cut-off portion reaches one minute or more, this program will be displayed with error number E40 on the timer programming list.

- **When the End time of the programming currently being recorded and the Start time of the subsequent program are same:**
If PROG. 1 is recorded on a DVD, the beginning of the PROG. 2 may be cut off. The amount of time cut off differs depending on the recording media. For example, if both PROG. 1 and PROG. 2 are recorded on DVD, the first 30 seconds (at the longest) of PROG. 2 will be cut off.

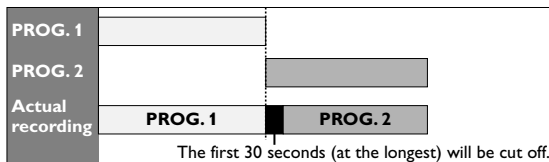

Recording

Settings for an external source

Connection to an external source



Connect the external source properly to the unit by using input jacks either LINE2 (Front) or LINE1 (Rear). When connecting an external equipment of monaural output to this unit, use AUDIO L jack of LINE 1 (Rear) or LINE 2 (Front).

Use commercially available S-Video or Video cable and an Audio cable for this type of connection.

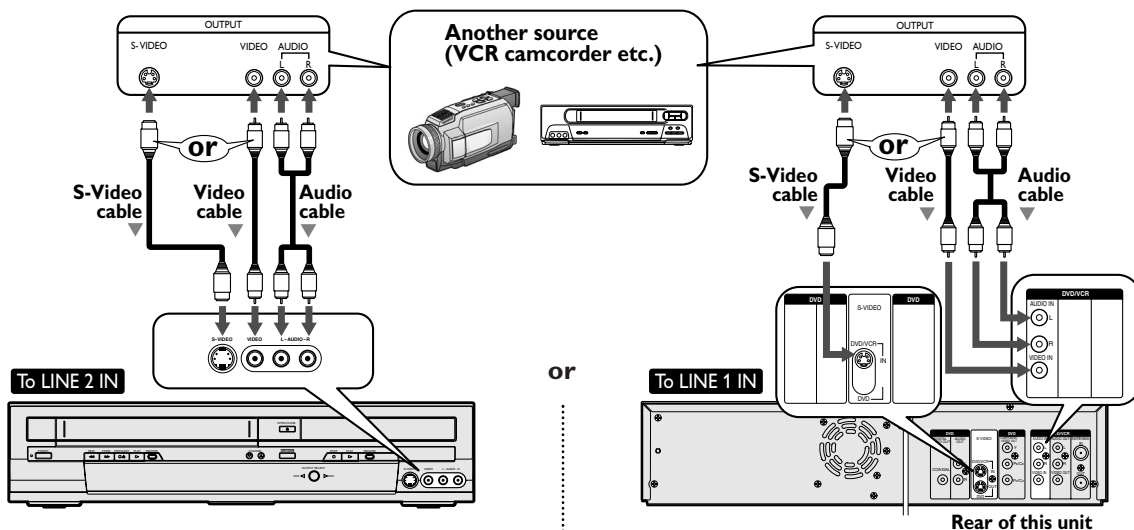

1. Press [SETUP] to display Easy Setting Menu or Advanced Setting Menu.
If Advanced Setting Menu is displayed, proceed to step 3.
2. Using [▲ / ▼], select “Advanced Setting Menu”. Press [ENTER].
3. Using [▲ / ▼], select “Select Video”. Press [ENTER].

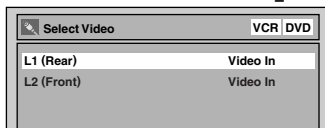

4. Using [▲ / ▼], select “L2 (Front)”. Press [ENTER].

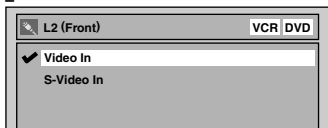

5. Using [▲ / ▼], select the input jack type to connect. Press [ENTER].
If you want to use S-VIDEO input, select “S-Video In”.
If you want to use VIDEO input (Composite), select “Video In”.

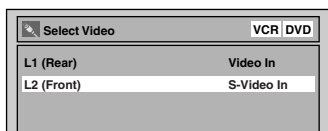

4. Using [▲ / ▼], select “L1 (Rear)”. Press [ENTER].

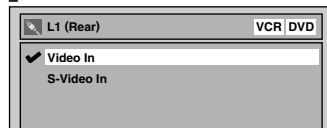

5. Using [▲ / ▼], select the input jack type to connect. Press [ENTER].
If you want to use S-VIDEO IN, select “S-Video In”.
If you want to use VIDEO IN (Composite), select “Video In”.

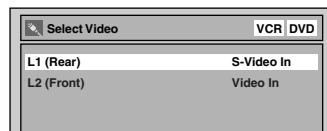

Recording

Settings for an external source (cont'd)

Recording from an external source



Before recording from an external source, see the instructions for the connection on page 34.

1. Turn on the TV and the unit and be sure to select the input of the TV to which the unit is connected.

Refer to the table on page 15.

2. When you want to record to the disc: Press: Press [OPEN/CLOSE ▲] to open the disc tray. Place the disc to record.

3. Press [OPEN/CLOSE ▲] to close the disc tray.

This operation may take a while to be recognized.

When you want to record to a videotape: Press: Insert the videotape with a record tab into the cassette compartment.

4. Select the input of the unit which the external equipment is connected. (L2 or L1)

- To use the input jacks on the back of this unit, select “L1” position by pressing **0,0,1** on the remote control or [CHANNEL ▲ / ▼].

- To use the input jacks on the front of this unit, select “L2” position by pressing **0,0,2** on the remote control or [CHANNEL ▲ / ▼].

5. Select a recording speed by pressing [REC SPEED].

Refer to “Recording speed” on page 25 for DVD or page 75 for VCR.

6. Press [RECORD] (VCR/DVD) on the unit to start recording.

7. Press “Play” on the external source to record from.

8. For disc:

Press [STOP ■] on the unit to stop recording.

This operation may take a while to be completed.

For videotape:

Press [STOP ■ / EJECT ▲] on the unit to stop recording.

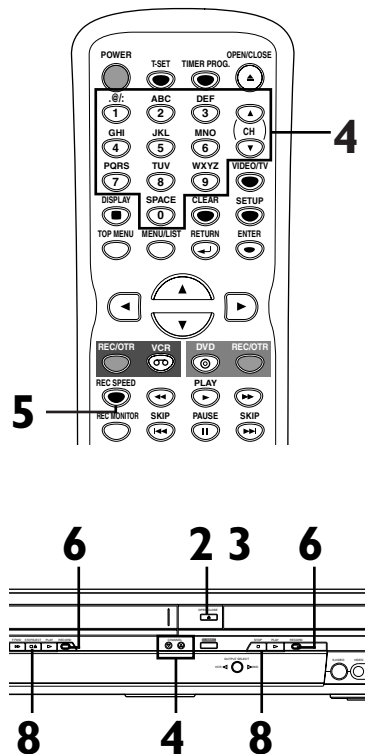

Setting a disc to protect



To prevent accidental recording, editing or erasing of the titles, you can protect them from the Setting menu.

1 Press [SETUP].

Easy Setting Menu or Advanced Setting Menu will appear.

2 Using [▲ / ▼], select “Disc”. Press [ENTER].

Disc menu will appear.

3 Using [▲ / ▼], select “Disc Protect OFF → ON”. Press [ENTER].

Confirm window will appear.

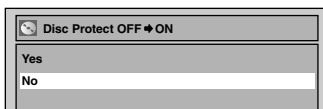

4 Using [▲ / ▼], select “Yes”. Press [ENTER].

A disc will be protected.



This operation may take a while to be completed.

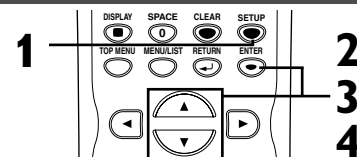

Note

- The Disc Protect setting is available only for a DVD-RW disc recorded in VR mode.
- You can select only Disc Protect off when a protected disc is inserted.

To cancel the disc protect:

- When you insert a disc protected in this unit, “Disc Protect ON → OFF” will appear .

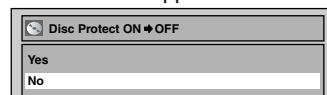

To cancel the protection setting for the disc, select “Disc Protect ON → OFF” at step 3, then select “Yes”.

Recording

Finalizing the discs



You will need to finalize discs recorded in Video mode to play them back on other DVD players. Finalizing may take several minutes up to an hour. (It can take up to 15 minutes for a disc recorded in Video mode and 60 minutes for a disc recorded in VR mode.)

A shorter recording period on the disc will require a longer time period for finalization. Do not unplug the power cord during finalization. Details are on pages 25-26.

1

Press **[SETUP]**.

Easy Setting Menu or Advanced Setting Menu will appear.

2

Using **[▲ / ▼]**, select "Disc". Press **[ENTER]**.

Disc menu will appear.

3

Using **[▲ / ▼]**, select "Finalize". Press **[ENTER]**.

Confirmation window will appear.

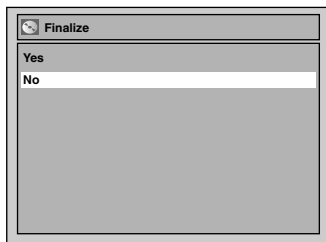

4

Using **[▲ / ▼]**, select "Yes". Press **[ENTER]**.

Finalizing will start.



To cancel finalizing... (DVD-RW only)

- To cancel finalizing at step 4, press **[STOP ■]**, select "Yes", then press **[ENTER]**. Finalizing is cancelled and the DVD recorder will be in stop mode.

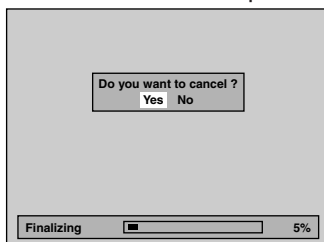

- If  appear when pressing **[STOP ■]**, you cannot cancel finalizing because the finalizing has progressed a certain point.
- When selecting "No", press **[ENTER]** or **[RETURN ←]**, finalizing will be continued.
- You cannot cancel finalizing the DVD-R disc once it has started.

This operation may take a while to be completed.

5

Finalizing is complete.

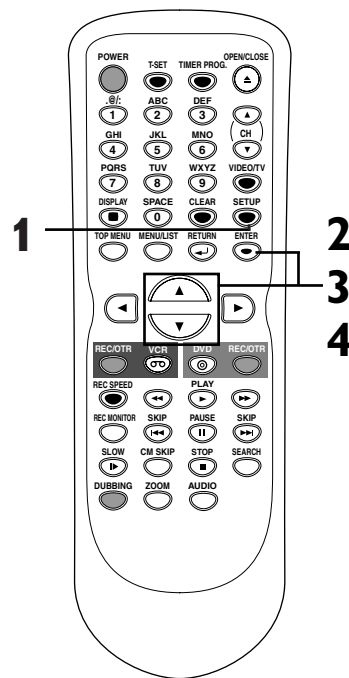

Note

- Finalizing discs in Video mode automatically creates title menus.
- Once you have finalized a disc recorded in Video mode, you cannot edit or record anything else on that disc. Discs recorded in VR mode can still be recorded and edited on this unit even after finalization.
- When you insert a DVD-RW disc finalized with this unit, "Undo Finalize" will appear instead of "Finalize".

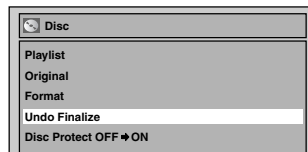

To reverse the finalization of the disc, select "Undo Finalize" at step 3.

*DO NOT power off during finalization. This will result in malfunction.

Recording

Finalizing the discs (cont'd)

Auto finalize



This function automatically finalizes discs after all Timer Recordings are completed and when the disc space runs out.

1

Press [SETUP].

Easy Setting Menu or Advanced Setting Menu will appear. If Easy Setting Menu is displayed, proceed to step 3.

2 (Advanced Setting Menu only)

Using [▲ / ▼], select "Recording". Press [ENTER].

Option window will appear.

3

Using [▲ / ▼], select "Auto Finalize". Press [ENTER].

Option window will appear.

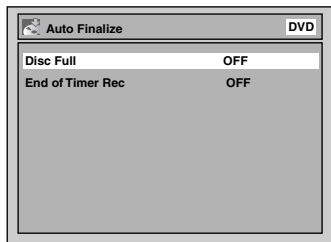

4

Using [▲ / ▼], select "Disc Full" or "End of Timer Rec".

Press [ENTER].

Option window will appear.

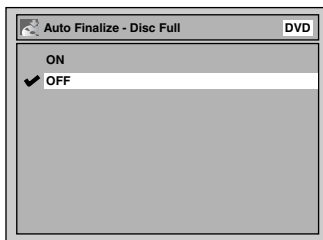

<Example: Disc Full>

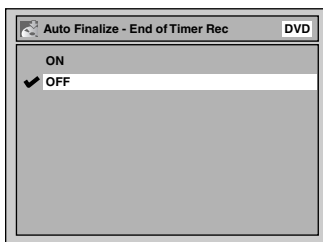

<Example: End of Timer Rec>

5

Using [▲ / ▼], select "ON".

Press [ENTER].

Your setting will be activated.

6

Press [SETUP] to exit.

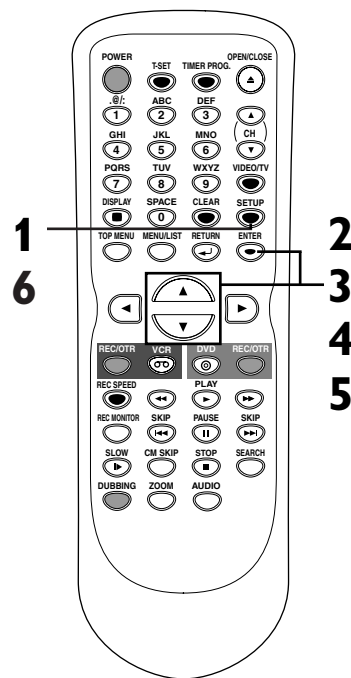

Note

- Auto Finalize is not available for discs recorded in VR mode.

Recording

Dubbing Mode



You can copy a DVD disc to a videotape or copy a videotape to a DVD disc. This function will be possible only if the DVD disc or the videotape is not copy protected. Before starting this function, prepare for the recording on the DVD-RW/R disc or the videotape. Refer to pages 29 and 75.

Make sure:

- Insert a recordable disc and a videotape with a record tab.

Note for recording to a videotape:

- The videotape's record tab is intact.
- The remaining time of the videotape is long enough.

Note for recording to a disc:

- Make sure that the disc is recordable. Refer to pages 25 and 26.

1

Press **[SETUP]**.

Easy Setting Menu or Advanced Setting Menu will appear.

If Advanced Setting Menu is displayed, proceed to step 3.

2

Using **[▲ / ▼]**, select “Advanced Setting Menu”.

Press **[ENTER]**.

Advanced Setting Menu will appear.

3

Using **[▲ / ▼]**, select “Recording”. Press **[ENTER]**.

Recording menu will appear.

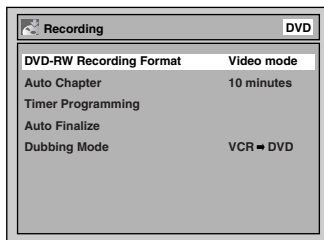

4

Using **[▲ / ▼]**, select “Dubbing Mode”. Press **[ENTER]**.

Option window will appear.

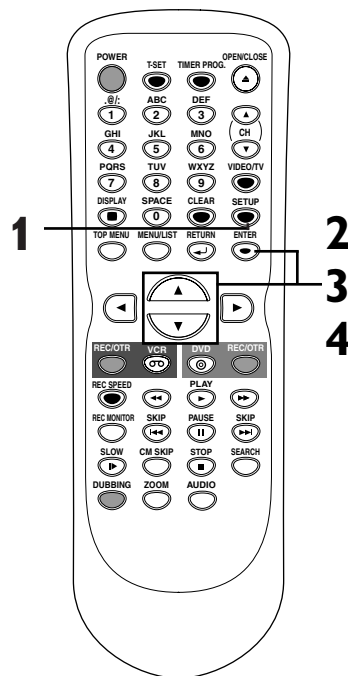
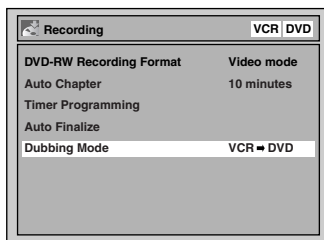

Note

For VCR to DVD duplication:

- After starting VCR to DVD duplication, the picture may be distorted because of the auto tracking function. This is not a malfunction. Be advised to playback the videotape until the picture is stabilized, then set the starting point which you wish to start recording, and start VCR to DVD duplication.

Recording

Dubbing Mode (cont'd)

VCR to DVD

5

Using [**▲** / **▼**], select “VCR → DVD”. Press [**ENTER**].

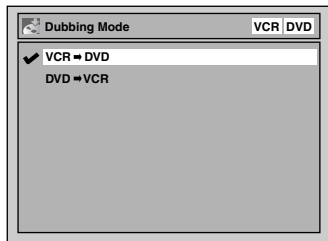

6

Press [**SETUP**] to exit.

Press:

Make sure to select a recording speed using [**REC SPEED**].

Press:

7

Press [**PLAY ►**]. Then press [**PAUSE II**] at the point you wish to start recording.

- Since it takes about a few seconds before the actual dubbing begins, please allow extra 5 seconds when selecting the starting point.

8

Press [**DUBBING**].

VCR to DVD duplication will start.

9

Press [**STOP ■**] to stop the recording.

DVD to VCR

5

Using [**▲** / **▼**], select “DVD → VCR”. Press [**ENTER**].

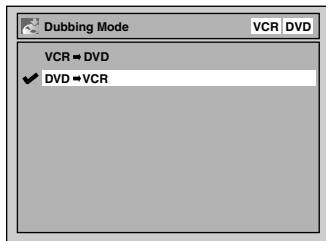

6

Press [**SETUP**] to exit.

Press:

Make sure to select a recording speed using [**REC SPEED**].

Press:

7

Press [**PLAY ►**]. Then press [**PAUSE II**] at the point you wish to start recording.

8

Press [**DUBBING**].

DVD to VCR duplication will start.

9

Press [**STOP ■**] to stop the recording.

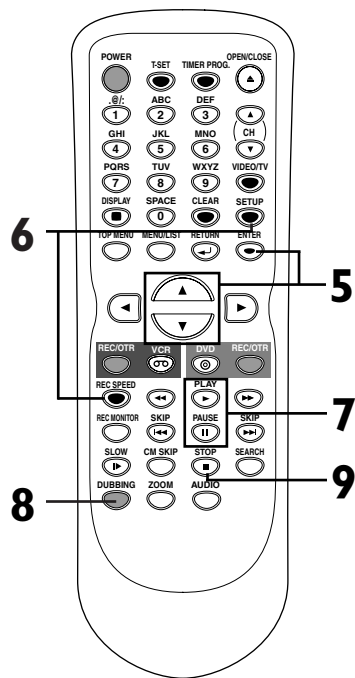

Note

- When you turn off the unit after setting the Dubbing Mode to **DVD → VCR**, the setting will be set to **VCR → DVD** automatically.
- Dubbing Mode is available only if the videotape or disc is not copy protected.
- You cannot change the output mode during VCR to DVD or DVD to VCR duplication.

For DVD to VCR duplication:

- While Audio CDs can be copied to videotapes, MP3 cannot be.

For VCR to DVD duplication:

- The playback sound mode is followed by the setting of VCR playback sound mode on page 77. Set the playback sound mode to which you wish to record to the DVD.

Disc Playback

Information on DVD playback

Before you play back DVD discs, read the following information.

Playable discs

This unit is compatible with the following discs. To play back a DVD, make sure that it meets the requirements for Region Codes and Color Systems as described below. Discs with the following logos can be played back on the unit. Other Disc types are not guaranteed to be played back.

Disc	Logo
DVD-VIDEO	
DVD-RW (VIDEO/VR mode)	
DVD-R (VIDEO mode)	
CD-DA (AUDIO CD)	
CD-RW (CD-DA FORMAT, MP3 files)	 
CD-R (CD-DA FORMAT, MP3 files)	 

DVD is a trademark of DVD Format/Logo Licensing Corporation.

Color systems

DVDs are recorded in different color systems throughout the world. The most common color system is NTSC (which are used primarily in the United States and Canada).

This unit uses NTSC, you must use DVDs recorded in the NTSC system. You cannot play back DVDs recorded in other color systems.

Region codes

This unit has been designed to play back DVD discs with Region One (1). DVDs must be labeled for ALL regions or for Region 1. You cannot play back DVDs labeled for other regions. Look for the symbols below on your DVDs. If these region symbols are not on your DVD, you cannot play back the DVD on this unit.



The number inside the globe refers to region of the world. A DVD labeled for a specific region can only be played back on the unit with the same region code.

Hint for DVD playback

The contents of DVD disc are generally divided into titles. Titles may be further subdivided into chapters.

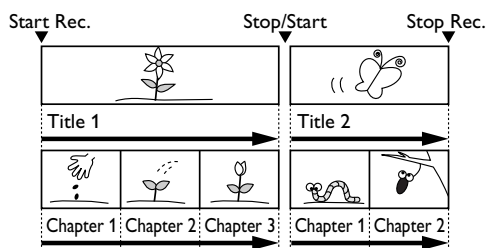

Disc Playback

Basic playback

Playback



1

Press **[POWER]**. Press **[DVD]**.

When you are playing back a DVD, turn on the TV and be sure to select the input to which the unit is connected.

2

Press **[OPEN/CLOSE ▲]**. The disc tray will open.

3

Insert your disc with its label facing up. Align the disc to the disc tray guide.

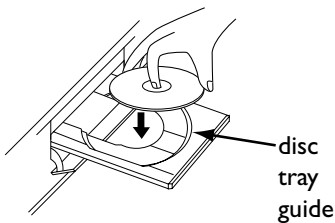

4

Press **[OPEN/CLOSE ▲]** to close the disc tray.

This operation may take a while to be recognized.

5

Press **[TOP MENU]** to display the title menu. You can change "Original" or "Playlist" of VR mode using **[MENU/LIST]**.

Video mode:

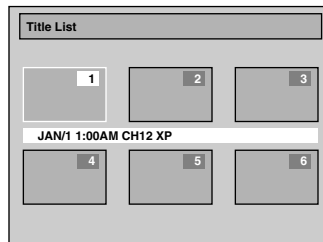

VR mode:

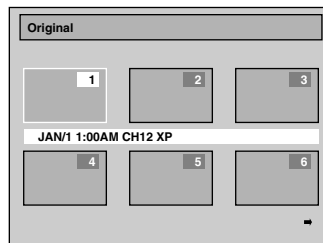

[MENU/LIST]

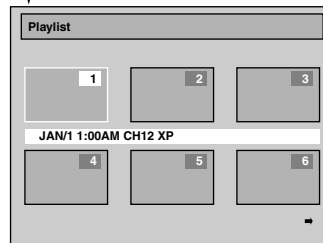

To exit the title menu, press **[TOP MENU]** again.

6

Using **[▲ / ▼ / ◀ / ▶]**, select a desired title. Press **[ENTER]**. Playback will start.

7

Press **[STOP ■]** to stop playback.

To eject the disc, press **[OPEN/CLOSE ▲]** to open the disc tray, then remove the disc before turning off the unit.

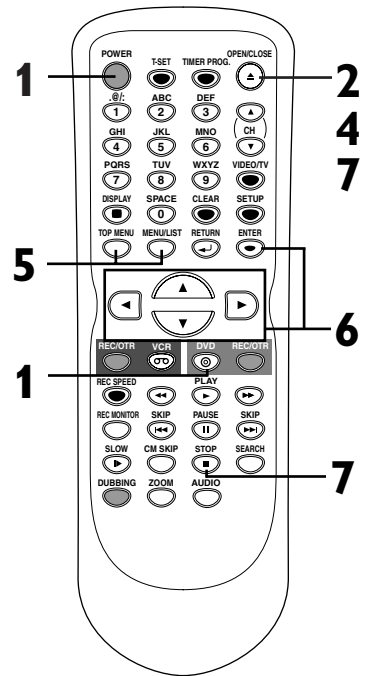

Note

- For DVD-R (Video mode) and DVD-RW (Video mode) discs which are already finalized, a title list will be displayed instead of thumbnails.

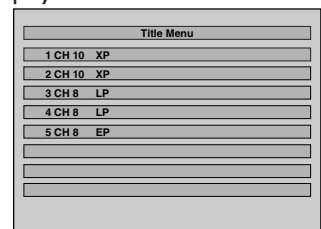

- You can resume playback from the point you stopped playback. (Resume playback) Refer to page 44 for details about resume playback.
- Some discs may start playback automatically.

Disc Playback

Basic playback (cont'd)



1
Press **[POWER]**. Press **[DVD]**.

When you are playing back a DVD or an audio CD, turn on the TV and be sure to select the input to which the unit is connected.

2
Press **[OPEN/CLOSE ▲]** to open the disc tray.
The disc tray will open.

3
Insert your disc with its label facing up. Align the disc to the disc tray guide.

4
Press **[PLAY ►]** to start playback.
Playback will start.

If you are playing back a DVD-Video disc, a menu may appear. Refer to page 43 for details about a disc menu.

5
Press **[STOP ■]** to stop playback.

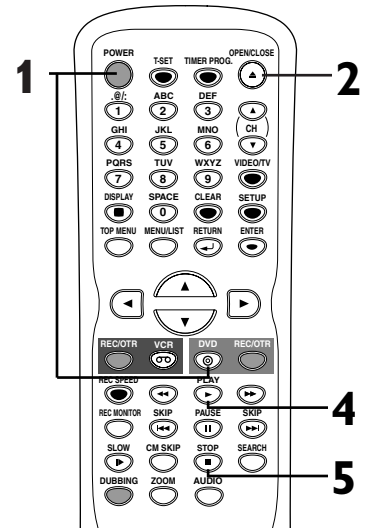

Note
• Some discs may start playback automatically.

Playing back MP3 disc



1
In stop mode, press **[TOP MENU]** to call up the MP3 menu.

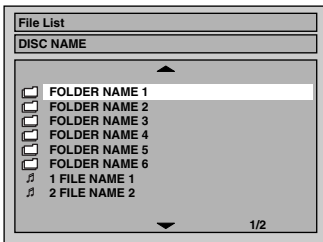

• To exit the menu, press **[TOP MENU]** again.

2
Press **[▲ / ▼]** to select a desired folder (group) or track. Press **[ENTER]**.

When selecting track:
Playback will start.

When selecting the folder:
The files in the folder will appear. Use **[▲ / ▼]** to select the track or folder you want, then press **[ENTER]**.

- Press **[PLAY ►]**, **[ENTER]** or **[►]** to move to the lower hierarchies.
- Press **[◀]** or **[RETURN ↵]** to go to the previous hierarchy.
- Press **[STOP ■]** to return to the first item.

Hints for MP3 files:

- Folders are known as Groups, files are known as Tracks.
 - Folders are accompanied by icon.
 - MP3 files are accompanied by icon.
- Reproduction will start from the selected track and go to the next one in turn.
- The system can recognize up to 255 groups (or folders) and up to 255 tracks.
 - The name of the group and track can be displayed in up to 29 characters. Unrecognizable characters will be replaced with asterisks.
 - If there are no files in the folder, "No Files" will be displayed.

This unit recommends the files recorded under the following circumstances:

- Sampling frequency: 44.1kHz or 48kHz.
- Constant bit rate: 112kbps - 320kbps.

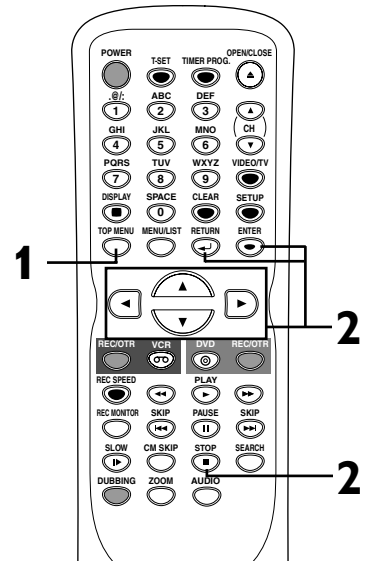

Note
• The audio source of MP3 files cannot be recorded as digital sound by an MD or DAT deck.
• Files whose extension other than ".mp3 (MP3)" will not appear in the MP3 menu.
• Some unplayable folders or tracks may appear in the MP3 menu due to the recording status.

Disc Playback

Basic playback (cont'd)

Playing back discs using the disc menu



A DVD disc contains a disc menu that describes the contents or allows you to customize the playback. For example, the menu may offer choices for subtitle languages, special features, or chapter selection. Some discs display them automatically when you start playback. For others, they only appear when you press **[MENU / LIST]**.



1

Press **[MENU/LIST]**.

The disc menu will appear.

If the feature is not available, may appear on the TV screen.

2

Using **[▲ / ▼ / ◀ / ▶]**, select an item. Press **[ENTER]** to confirm.

Continue this step to set up all the features you want or to start playing back the disc from the menu.

MENU/LIST button:

Displays a DVD disc menu. It may be the same with the 'Title menu.'

Cursor ▲ / ▼ / ◀ / ▶ buttons:

Moves the cursor on the screen.

ENTER button:

Selects the currently highlighted menu option.

Number buttons:

Selects a numbered menu option (some discs only). Press **[ENTER]** after.

3

Press **[MENU/LIST]** to exit the disc menu.

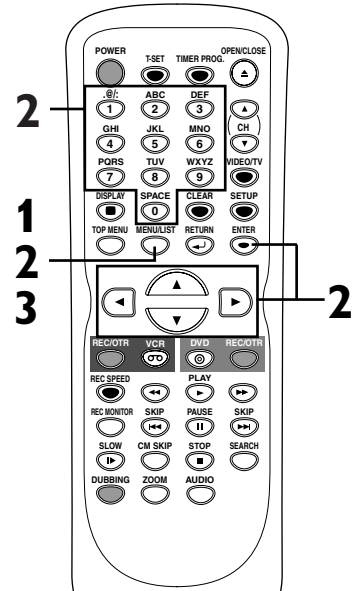

Note

- Menus vary among discs. Refer to the information accompanying the disc for details.

Playing back discs using the title menu



Some DVDs have a title menu, which lists the titles available on them. It helps you to start playback at a specific title.



1

Press **[TOP MENU]**.

The title menu will appear.

If the feature is not available, may appear on the TV screen.

2

Using the **[▲ / ▼ / ◀ / ▶]**, select a title to play. Press **[ENTER]**.

Playback will begin at the title you selected.

TOP MENU button:

Displays the 'Title menu' of a DVD disc.

Cursor ▲ / ▼ / ◀ / ▶ buttons:

Moves the cursor on the screen.

ENTER button:

Selects the current highlighted menu option.

Number buttons:

Selects a numbered menu option (some discs only). Press **[ENTER]** after.

3

Press **[TOP MENU]** to exit the title menu.

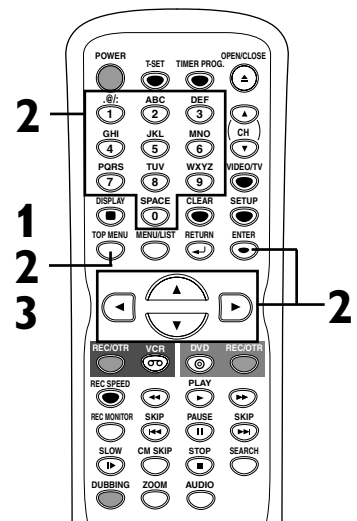

Note

- **[TOP MENU]** will not always be active with all DVDs.
- Menus vary among discs. Refer to the information accompanying the disc for details.

Disc Playback

Special playback

Resume playback



You can resume playback from where you stopped it last time.

1

During playback, press **[STOP ■]**.

The resume message will appear.



2

Press **[PLAY ►]**.

Within a few seconds, playback will resume from the point at which it stopped last. You can resume playback at the same point even if you turn off the unit.

To cancel resuming and start disc playback from the beginning, press **[STOP ■]** again while the play is stopped.

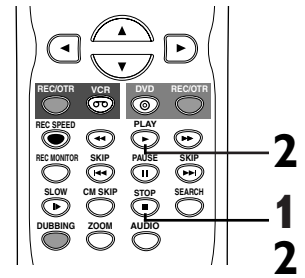

Note

- For MP3 files, playback will resume from the beginning of the track which you stopped playing back.

Fast forward / Fast reverse



1

During playback, press **[▶▶▶]** or **[◀◀◀]**.

Every time you press **[▶▶▶]** or **[◀◀◀]**, approximate speed will be changed as follows. For DVD discs, sound will be output during x1.5 fast forward only if you set “Fast Forward with Audio” to “ON” at the “Playback” setting in the Setting menu.

Fast forward or fast reverse playback across titles (for DVD discs) or tracks (for MP3) is not possible.

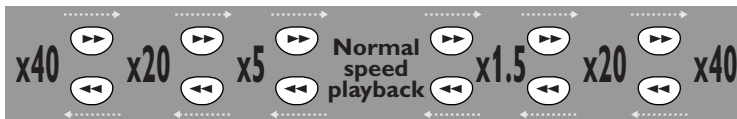

For Audio CDs, approximate speed is fixed at x8 with sound.

For MP3 files, approximate speed is fixed at x16.

To return to the normal playback, press **[PLAY ►]**.

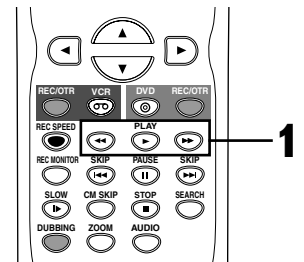

Note

- Forward/reverse speed will be indicated with icons as follows.
Forward (Approx. Speed)
x1.5: ▶▶▶
x20: ▶▶▶▶
x40: ▶▶▶▶▶
Reverse (Approx. Speed)
x5: ◀◀◀
x20: ◀◀◀◀
x40: ◀◀◀◀◀

Skipping TV commercials during playback



You can skip TV commercials by pressing **[CM SKIP]**, in order to enjoy the recorded programs without interruption.

1

During playback, press **[CM SKIP]**.

Normal playback will start at 30-seconds advanced from where you press **[CM SKIP]**.

Every time you press **[CM SKIP]**, the playback starting point will be extended by 30 seconds ahead.

You can press up to 6 times (180 seconds).

e.g. Press **[CM SKIP]** once



(forwarding 30 seconds.)



Playback will restart automatically.

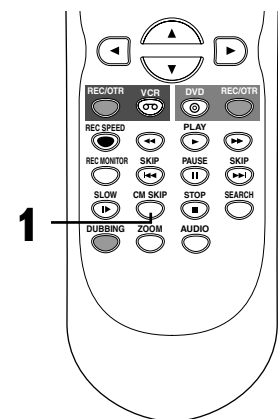

Disc Playback

Special playback (cont'd)

Pause



1

During playback, press [PAUSE II].

Playback will pause and sound will be muted.

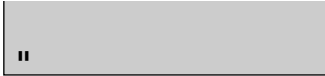

2

Press [PLAY ►] to resume play.

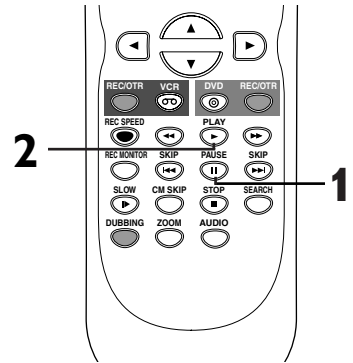

Step by step playback



1

During playback, press [PAUSE II].

Playback will be paused and sound will be muted.



To playback step by step backward:

Press [SKIP ◀◀] repeatedly. Every time you press the button, the playback will go backward by one frame at a time.

- Press and hold [SKIP ◀◀ / ▶▶] to advance/reverse continuously.

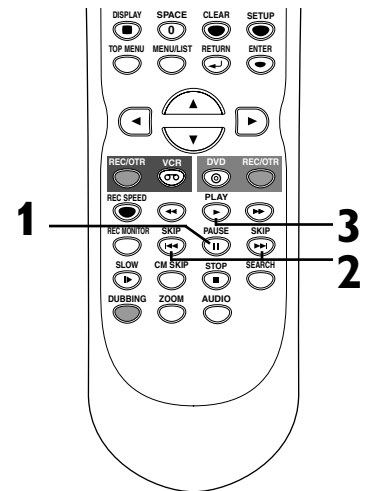

2

Press [SKIP ▶▶] repeatedly. The playback will advance one frame (or step) at a time when you press [SKIP ▶▶]. The sound will be muted.

3

Press [PLAY ►] to resume playback.

Slow forward / Slow reverse playback



1

During playback, press [PAUSE II]. Press [▶▶] or [◀◀].

Every time you press [▶▶] or [◀◀], approximate speed will change as follows. (The sound will remain muted.)



To return to the normal playback, press [PLAY ►].

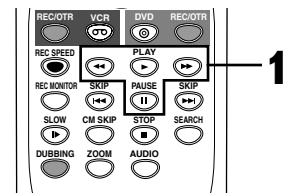

Note

- Forward/reverse speed will be indicated with icons as follows.
- Forward (Approx. Speed)
- x1/16: ▶▶▶▶
 - x1/8: ▶▶▶▶▶
 - x1/2: ▶▶▶▶▶▶▶▶
- Reverse (Approx. Speed)
- x1/16: ◀◀◀◀
 - x1/8: ◀◀◀◀◀
 - x1/4: ◀◀◀◀◀◀

Disc Playback

Special playback (cont'd)

Zoom



1

During playback, press [ZOOM].

Zoom menu will appear.



There are four options (x1.0, x1.2, x1.5 and x2.0), which will be displayed excluding the current zoom rate.

2

Using [▲ / ▼], select a desired zoom factor to zoom. Press [ENTER].

The zoom area will be displayed.

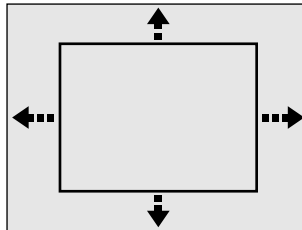

3

Using [▲ / ▼ / ◀ / ▶], select a desired zoom position. Press [ENTER].

The zoom play will start.

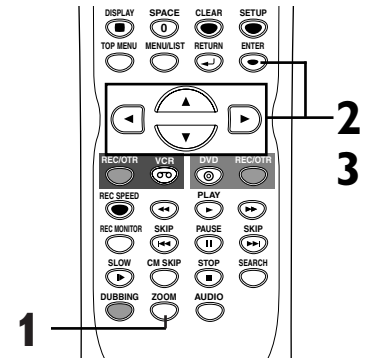

Note

- When selecting a smaller factor than the current one, the zoom area will not be displayed.
- To remove the zoom menu, press [ZOOM] again at step 1.
- To cancel the zoom, select x1.0 using [▲ / ▼], then press [ENTER].

Marker Setup



This function allows you to assign a specific point on a disc to be called back later.

1

During playback, press [DISPLAY].

The display menu will appear.

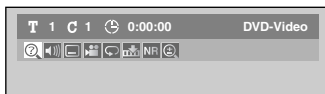

2

Using [◀ / ▶], select  icon. Press [ENTER].

Marker setup menu will appear.

Screen for DVD:

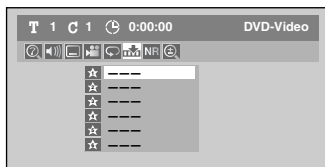

Screen for CD:

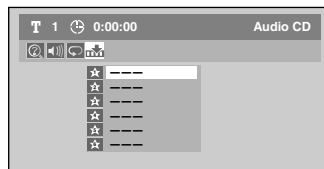

3

Using [▲ / ▼], select a desired marker number. When it reaches the desired point, press [ENTER].

The title (track) number and the time will be displayed.

4

To return to the marker later:

Using [▲ / ▼], select the desired marker number. Press [ENTER].

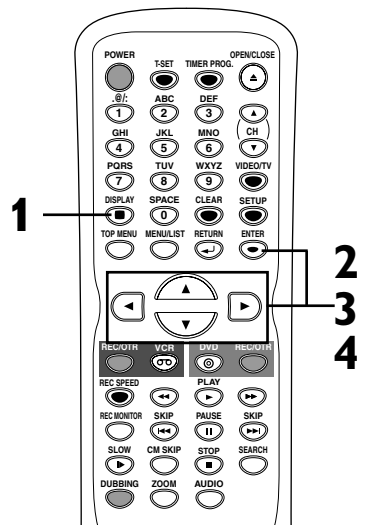

Note

- To clear a marker, select the marker number to be cleared, then press [CLEAR].
- All markers will be erased when you operate these operations listed below.
 - Opening the disc tray.
 - Turning off the power.
 - Recording to a recordable disc.
 - Changing the mode between Original and Playlist. (VR mode)
- You can mark up to 6 points.

Disc Playback

Search

Title/Chapter search



Using [SKIP << / >>]

1

During playback, press [SKIP >>] to skip the current title or chapter and move to the next.

To go back to the beginning of the current title or chapter, press [SKIP <<]. Press it repeatedly to go to the previous titles or chapters.

Using [DISPLAY]

1

During playback, press [DISPLAY].

The display menu will appear.

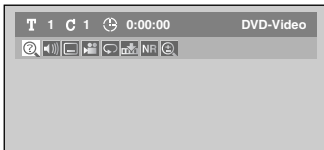

2

Using [◀ / ▶], select icon. Press [ENTER].

The title number next to **T** will be highlighted.

Title:

Using [▲ / ▼] or the Number buttons, enter a desired title number to search. Press [ENTER].

Title search will start.

Chapter:

To move to **C** for chapter, press [▶].

Using [▲ / ▼] or the Number buttons, enter a desired chapter number to search. Press [ENTER].

Chapter search will start.

Note

- In search mode display, total numbers of each search contents (title/chapter/time) are shown as a denominator.

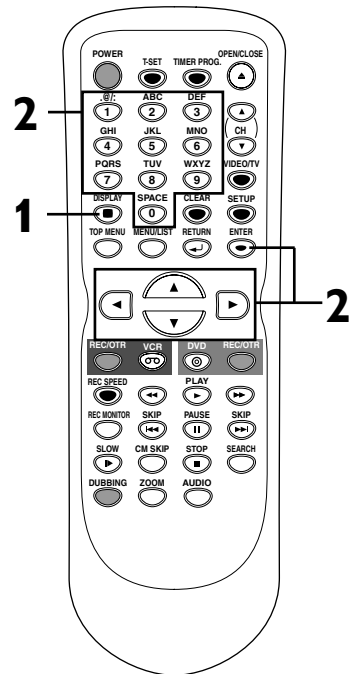
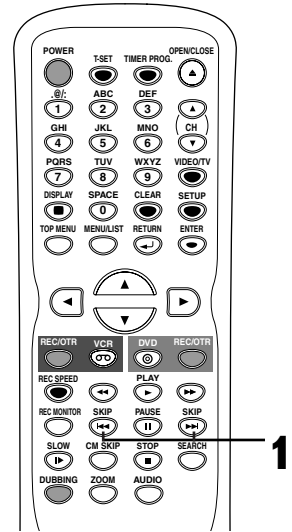
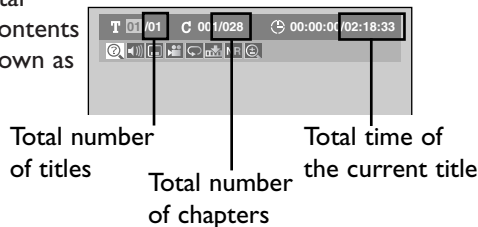

Disc Playback

Search (cont'd)

Track search



Using [SKIP ◀◀/▶▶]

1

During playback, press [SKIP ▶▶] to skip the current track and move to the next.

To go back to the beginning of the current track, press [SKIP ◀◀]. Press it repeatedly to go to the previous tracks.

Using [DISPLAY]

1

During playback, press [DISPLAY].

The display menu will appear.

Screen for CD:



Screen for MP3:

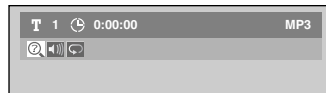

2

Using [◀/▶], select icon. Press [ENTER].

The track number next to **T** will be highlighted.

3

Using [▲/▼] or the Number buttons, enter a desired track number to search. Press [ENTER].

Track search will start.

Time search



1

During playback, press [DISPLAY].

The display menu will appear.

Screen for DVD:

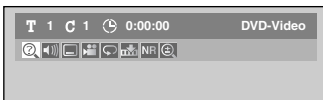

Screen for CD:

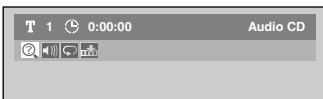

2

Using [◀/▶], select icon. Press [ENTER].

The number next to **T** will be highlighted.

To move to the clock icon , press [▶].

When time search is not available, “--:--:--/--:--:--” (“0:00:00/0:00:00” for CD) is displayed instead of time count.

3

Using [▲/▼] or the Number buttons, enter a desired time to search. Press [ENTER].

Time search will start.

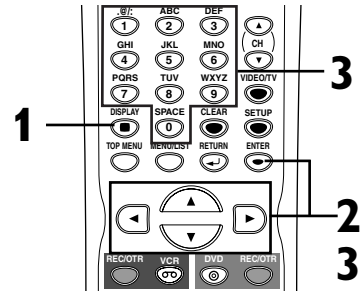
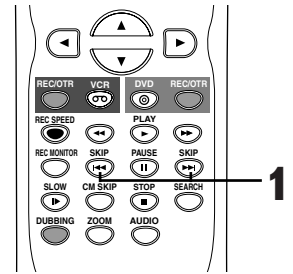

Note

- During CD playback you can enter a track number directly using the **Number buttons** for track search without displaying the menu (except during random and program playback).

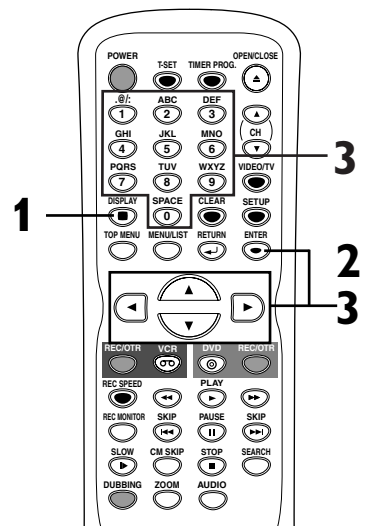

Note

- Time search is available only within the same track or title.

Disc Playback

Repeat/Random/Program playback

Repeat playback



1
During playback, press [DISPLAY].

The display menu will appear.

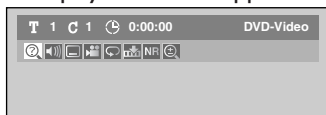

2
Using [◀/▶], select icon. Press [ENTER]. Repeat menu will appear.

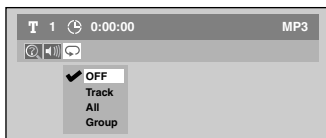
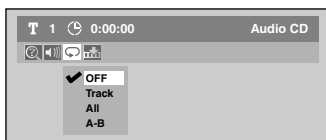
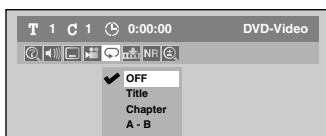

3
Using [▲ / ▼], select a desired option for repeat playback. Press [ENTER].

The selected repeat playback will start.

Title:

The current title will be played back repeatedly. (DVD only)

Chapter:

The current chapter will be played back repeatedly. (DVD only)

All:

The current disc will be played back repeatedly. (CD, MP3, DVD-RW (VR mode) only)

A-B:

The A-B point will be played back repeatedly.

When pressing [ENTER] while A-B is highlighted, the unit becomes ready for the input. Press [ENTER] again to decide the starting point (A). Press [ENTER] after setting point A to select the ending point (B).

Track:

The current track will be played back repeatedly. (CD, MP3 only)

Group:

The current group will be played back repeatedly. (MP3 only)

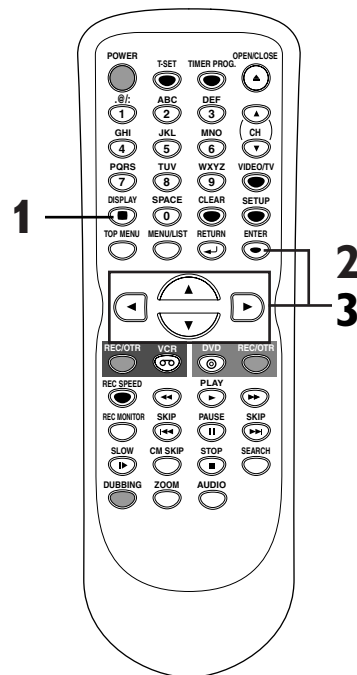

Note

- The A-B Repeat playback can only be set within the current title (for DVDs), or current track (for Audio CDs).
- To cancel the repeat playback, select “OFF” at step 2. The repeat setting will be also cleared when you stop playback.
- You cannot select “Group” for repeat playback during the random playback of MP3 files.

Random playback



You can play back a disc randomly instead of playing back in the original order.

First:

1
Press [SETUP].
Easy Setting Menu or Advanced Setting Menu will appear.

2
Using [▲ / ▼], select “CD Playback Mode”. Press [ENTER].

CD Playback Mode menu will appear.

3
Using [▲ / ▼], select “Random Play”. Press [ENTER].
Random playback will start.

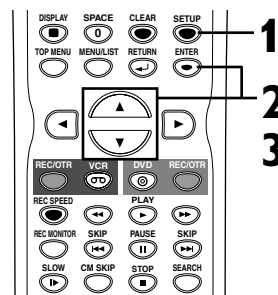

Note

- To cancel random playback, press [STOP ■] twice during random playback. “Playmode OFF” appears on the screen.

Disc Playback

Repeat/Random/Program playback (cont'd)

Program playback



You can program a playback sequence in your desired order.

First: 

1
Press **[SETUP]**.

Easy Setting Menu or Advanced Setting Menu will appear.

2
Using **[▲ / ▼]**, select “**CD Playback Mode**”. Press **[ENTER]**.

CD Playback Mode menu will appear.

3
Using **[▲ / ▼]**, select “**Program Play**”. Press **[ENTER]**.

Program play list will appear.

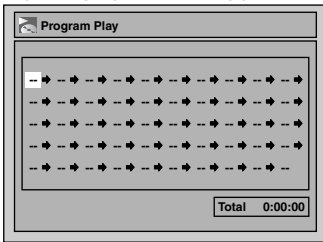

4
Using **[▲ / ▼]** or the **Number buttons**, select a desired track. Press **[ENTER]** or **[▶]**. A cursor will move to the next.

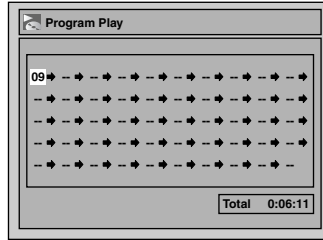

5
Press **[PLAY ▶]** to start program playback. Program playback will start.

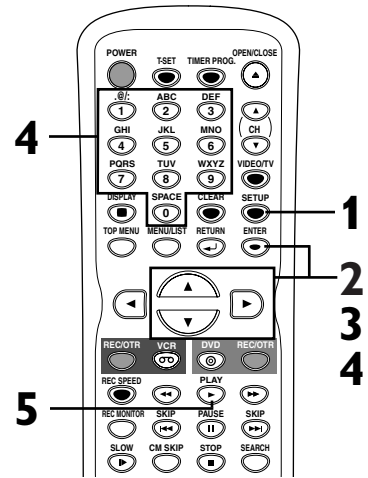

Note

- To erase tracks you selected, press **[CLEAR]**.
- You can make program settings up to 50.
- To cancel program playback, press **[STOP ■]** twice during program playback.
- “Playmode OFF” appears on the screen.
- You may also select a desired track using the **Number buttons** at step 4.

Selecting a format of audio and video

You can select a desired audio and video format. Selections depend on the contents of the disc you are playing back.

Switching subtitles



Many DVD-Video discs have subtitles in one or more languages – they usually tell you which subtitle languages are available. You can switch subtitle languages anytime during playback.

1
During playback, press **[DISPLAY]**. Display menu will appear.

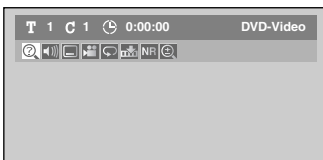

2
Using **[◀ / ▶]**, select  icon. Press **[ENTER]**. Subtitle menu will appear.

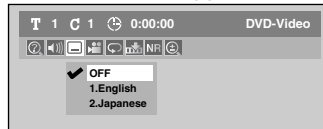

3
Using **[▲ / ▼]**, select a desired subtitle language. Press **[ENTER]**. Subtitles will be displayed in the selected language. When selecting “OFF,” subtitles will disappear.

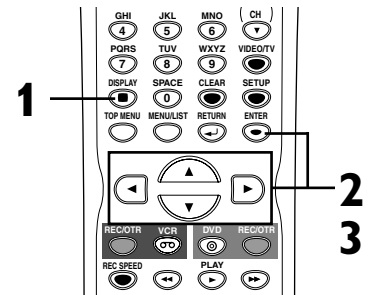

Note

- Some discs will only allow you to change subtitles from the disc’s menu. Press **[TOP MENU]** or **[MENU/LIST]** to display the disc menu.
- If a 4-digit language code appears in the subtitle menu at step 2, refer to the Language code on page 82.

Disc Playback

Selecting a format of audio and video (cont'd)

Switching audio soundtrack



When playing back a DVD-Video disc recorded with two or more soundtracks (these are often in different languages), you can switch among them during playback.

When playing back DVD-RW discs recorded in VR mode, you can switch to main audio (L), sub audio (R) or a combination of both (L/R). When playing back Audio CDs, you can switch among stereo, the left channel only and the right channel only.

1

During playback, press **[DISPLAY]**.

2

Using **[◀ / ▶]**, select  icon. Press **[ENTER]**. Audio menu will appear.

<DVD-Video>

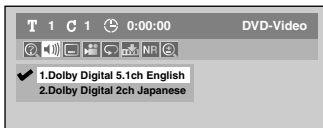

<DVD-RW VR mode>

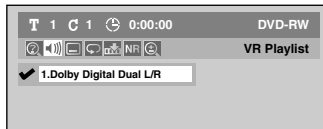

<Audio CD, MP3 files>

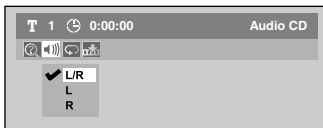

3

Using **[▲ / ▼]**, select a desired audio soundtrack or audio channel. Press **[ENTER]**.

<DVD-Video>

Audio soundtrack will change.

<DVD-RW VR mode>

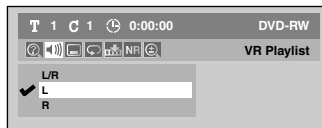

Audio channel menu will appear. Follow step 4.

<Audio CD, MP3 files>

Audio channel will change.

4

Using **[▲ / ▼]**, select a desired audio channel. Press **[ENTER]**.

Audio channel will change.

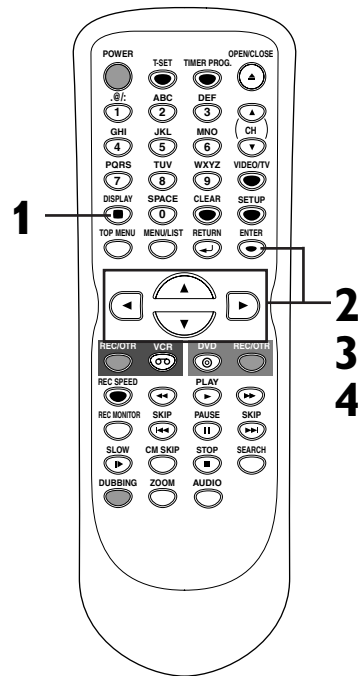

Note

- Some discs will only allow you to change the soundtrack from the disc menu. Press **[TOP MENU]** or **[MENU/LIST]** to display the disc menu.
- On DVD-RW discs recorded in VR mode with both main and sub audio, you can switch to main (L), sub audio (R) or a mix of both (L/R).
- This unit CANNOT record in both stereo and SAP (Secondary Audio Program) at the same time.

Disc Playback

Selecting a format of audio and video (cont'd)

Switching camera angles



Some DVD-Video discs feature scenes shot from two or more angles. The disc package should be marked with an angle icon if it contains multi-angle scenes.

1

During playback, press [DISPLAY].

Display menu will appear.

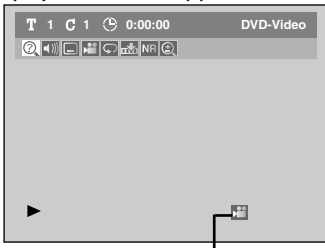

Angle icon appears when different camera angles are available.

2

Using [◀/▶], select  icon. Press [ENTER].

Angle will change each time you press [ENTER].

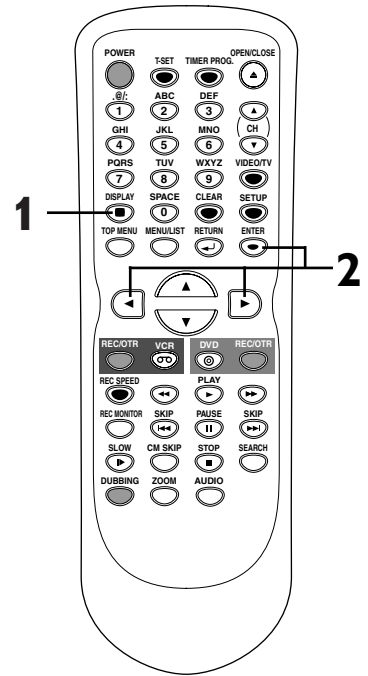

Visual Noise Reduction



1

During playback, press [DISPLAY].

Display menu will appear.

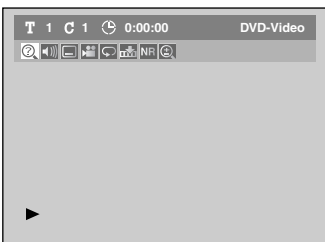

2

Using [▲/▼], select  icon. Press [ENTER].

Noise Reduction menu will appear.

3

Using [▲/▼], select a desired option. Press [ENTER].

Your setting will be activated.

This function reduces visual noise. When playing back discs recorded in long time mode such as SLP or SEP mode, select “Type 1” or “Type 2”. (“Type 2” is more effective.)

When playing back discs with a few noises such as DVD-Video discs, select “OFF”.

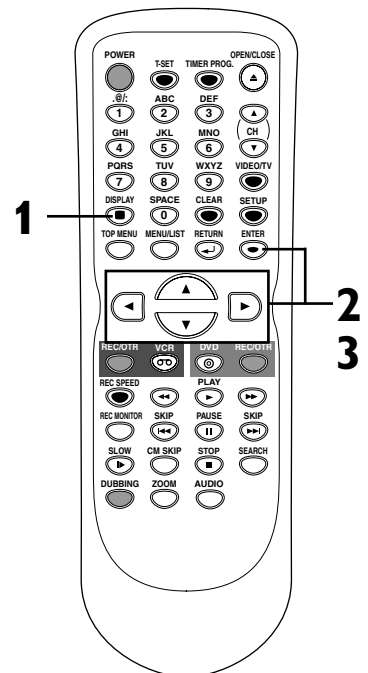

Information on disc editing

Guide to a title list

Title list allows you to check the titles recorded on the disc easily. You can choose a title to play it back from this screen and easily edit the titles as you prefer.

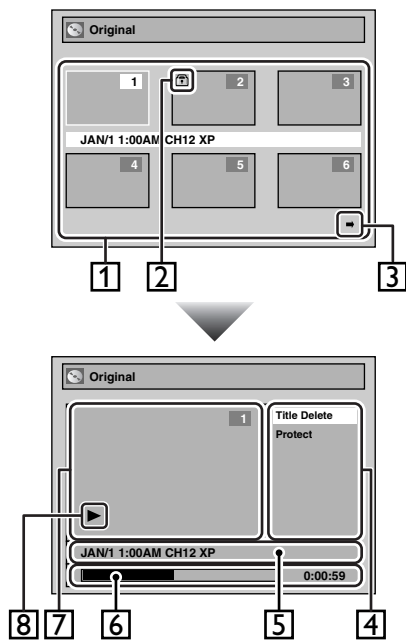

1. Titles recorded on the disc can be selected for editing by pressing **[ENTER]** with the cursor on the title.
2. Protect icon, which appears when the title has been protected (original titles only).
3. The arrow icon, which means the title list has a next or a previous page. Press **[◀ / ▶]** or **[SKIP ◀◀ / ▶▶]** by following direction of the icon.
4. Features for editing titles. The available menus depend on the disc type and the format type. An unavailable item is grayed out.
5. The details of the title. Title name can be changed on the Playlist.
6. Time status bar of the title.
After exiting the edit mode, you can resume playback from the point you stopped for editing.
7. The thumbnail of the title selected from the title list.
• The selected title will be played back automatically.
8. Playback status of the current disc.

Editing discs in Video mode

You can edit discs in Video mode for the following items. Be sure that once you edit titles, you cannot change them back to the original ones.

- Deleting titles (Refer to page 54)
- Putting names on titles (Refer to page 55)
- Setting or clearing chapter markers (Refer to page 56)

Note

- Once a disc is finalized, editing the disc or recording to the disc will not be available. (Except DVD-RW discs in VR mode.)
- A playlist is not available with the DVD-R discs and DVD-RW discs in Video mode.

Editing discs in VR mode

For discs in VR mode, you can use either “Original” menu or “Playlist” menu, which is created from the original, for editing.

Editing original titles

The following items are available for editing of the original titles.

- Deleting titles (Refer to page 57)
- Setting titles to protect (Refer to page 58)
- Releasing titles from protecting (Refer to page 59)

Editing playlists

You can create a playlist from original titles, in order to edit as you prefer without losing original titles.

The following items are available for editing on a playlist.

- Deleting titles (Refer to page 60)
- Deleting parts of titles (Refer to page 61)
- Putting names on titles (Refer to page 62)
- Setting or clearing chapter markers (Refer to page 63)
- Setting pictures for thumbnails (Refer to page 64)
- Dividing a title (Refer to page 65)
- Combining titles (Refer to page 66)
- Adding titles to a playlist (Refer to page 67)
- Deleting a playlist (Refer to page 67)

Note

- Once-edited original titles will not remain as recorded originally. When you want to leave the original as it is, edit the playlist.

After you finish all editing, press **[SETUP]** to exit the editing mode. “Writing to Disc” appears momentarily. If you open the disc tray, or press **[POWER]** to turn off the unit, or when a recording error occurs after editing, “Writing to Disc” also appears.

Deleting titles



You can delete titles which you do not need anymore.

Be advised that the titles once deleted cannot be recovered. In Video mode, recordable disc space of DVD-RW disc will increase when the last title on the title list is deleted. However, deleting the last title will not change recordable disc space of DVD-R discs.

For DVD-R or DVD-RW (in Video mode) discs once finalized, the title list cannot be selected for editing.

First: 

1
Press [SETUP]. Using [▲ / ▼], select "Disc". Press [ENTER]. Disc menu will appear.

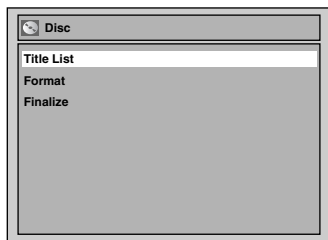

2
Using [▲ / ▼], select "Title List". Press [ENTER]. Title list will appear.

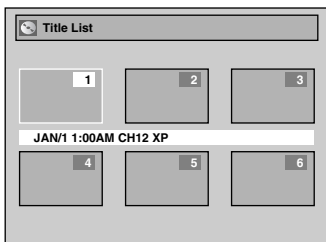

3
Using [▲ / ▼ / ◀ / ▶], select a desired title. Press [ENTER]. Edit menu will appear.

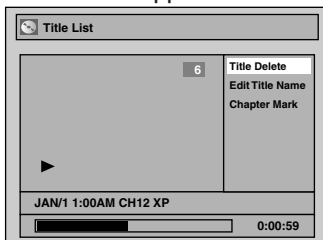

- You cannot select "Chapter Mark" when a DVD-R disc is inserted into the unit.

4
Using [▲ / ▼], select "Title Delete". Press [ENTER]. Confirmation window will appear.

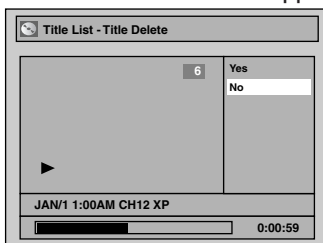

5
Using [▲ / ▼], select "Yes". Press [ENTER]. Title will be deleted.

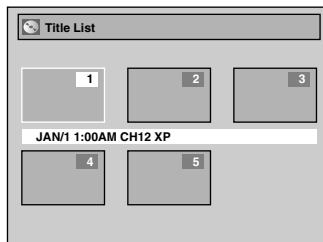

6
After this operation is completed, press [SETUP] to exit.

Writing the data on the disc will start momentarily.

This operation may take a while to be completed.

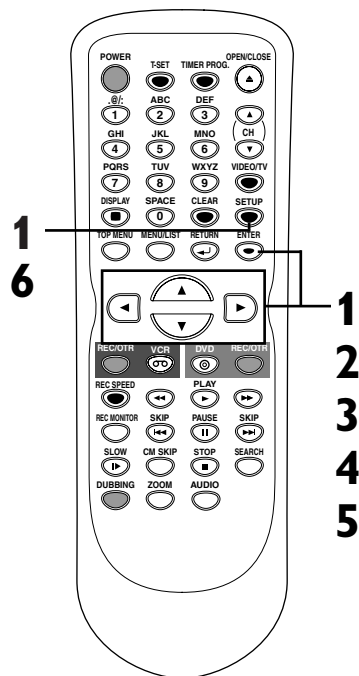

Editing discs in Video mode (cont'd)

Putting names on titles



You can name titles and change the names from this menu. The names you put on the titles will be displayed on a titlelist.

First: 

1

Follow steps 1 to 3 on page 54 to display the Edit menu.

Using **[▲ / ▼]**, select **"Edit Title Name"**. Press **[ENTER]**.

A window for entering a title name will appear.

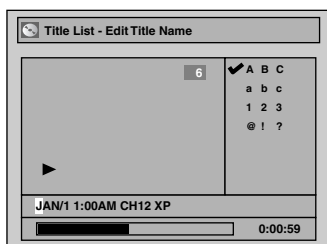

2

To enter a title name, follow the steps of **"Guide to edit title name"** on this page.

character set

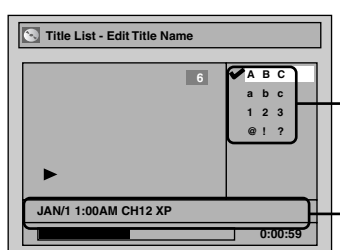

area for entering title names

When you finish entering a title name, press **[ENTER]**.

Confirmation window will appear.

3

Using **[▲ / ▼]**, select **"Yes"**. Press **[ENTER]**.

The name you entered will be activated.

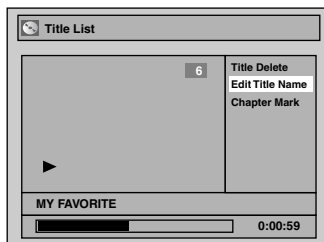

4

After this operation is completed, press **[SETUP]** to exit. Writing the data on the disc will start momentarily.

This operation may take a while to be completed.

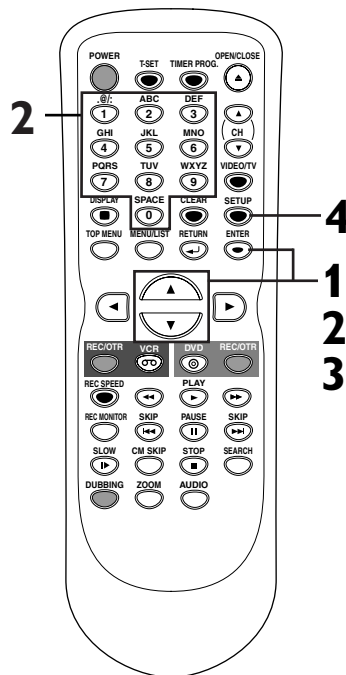

[Guide to edit title name]

[Step1]: Select a desired character set using **[▲/▼]**, then press **[ENTER]**.

A B C
a b c
1 2 3
@ ! ?

[Step2]: Follow the list below, press the **Number buttons** repeatedly until the desired letter appears. e.g. character set : A B C

Select Press	ABC	abc	123	@ ! ?
0	<space>	<space>	0	<space>
1	-	-	1	! " # \$ % & ' () * + , - . / : ; < = > ? @ [] ^ _ { }
2	A B C	a b c	2	-
3	D E F	d e f	3	-
4	G H I	g h i	4	-
5	J K L	j k l	5	-
6	M N O	m n o	6	-
7	P Q R S	p q r s	7	-
8	T U V	t u v	8	-
9	W X Y Z	w x y z	9	-

Note: Undefined letters in a title name are shown by "※". If you delete them, adjoining letters may change to "※" or other.

- Character set will be changed to the " @!?" automatically if you press **1** after you selected the "ABC" or "abc" mode.
- If you want to mix different character sets in one title, repeat Step [1] and [2] above.
- To delete letters, press **[CLEAR]** repeatedly. Hold **[CLEAR]** to delete all letters.
- To go on to the next entering area for letters, press **[▶]**.
- You can enter up to 30 letters.

Editing

Editing discs in Video mode (cont'd)

Setting or clearing chapter markers



You can put chapter markers on each title and use them for the chapter search.

You can specify time interval for chapter markers for titles last more than 5 minutes.

First: 

1

Follow steps 1 to 3 on page 54 to display the Edit menu.

Using [\blacktriangle / \blacktriangledown], select “Chapter Mark”. Press [ENTER].

Option window will appear.

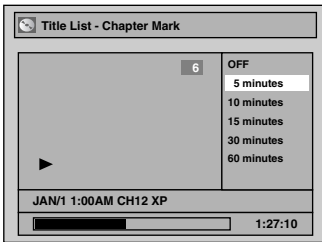

2

Using [\blacktriangle / \blacktriangledown], select a desired time. Press [ENTER].

Confirmation window will appear.

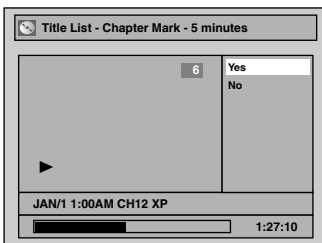

3

Using [\blacktriangle / \blacktriangledown], select “Yes”. Press [ENTER].

Chapter markers will be added. If you select “OFF” at step 2, all the chapter markers will be erased.

4

After this operation is completed, press [SETUP] to exit.

Writing the data on the disc will start momentarily.

This operation may take a while to be completed.

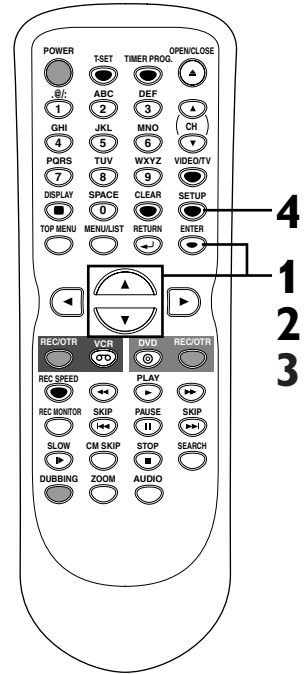

Note

- You cannot select a time interval for markers beyond a length of the title.
- The interval between markers may slightly deviate from the one specified at step 2.
- A chapter marker may be delayed according to the recording content.

Editing discs in VR mode (Original)

Deleting titles



When a title is deleted from an original list in VR mode, the recordable disc space will increase.

Be advised that the titles once deleted cannot be recovered.

First: 

1
Press [SETUP]. Using [▲ / ▼], select “Disc”. Press [ENTER]. Disc menu will appear.

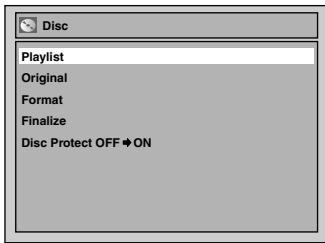

2
Using [▲ / ▼], select “Original”. Press [ENTER]. Original list will appear.

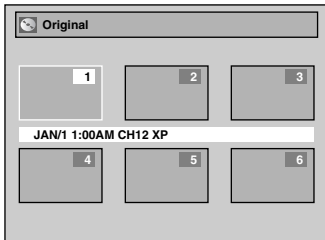

3
Using [▲ / ▼ / ◀ / ▶], select a desired title. Press [ENTER]. Original menu will appear.

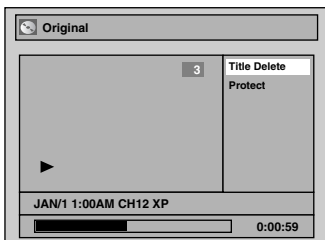

4
Using [▲ / ▼], select “Title Delete”. Press [ENTER]. Confirmation window will appear.

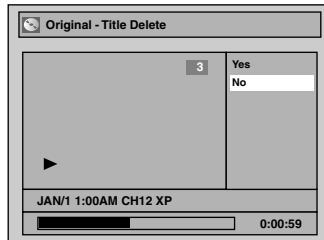

5
Using [▲ / ▼], select “Yes”. Press [ENTER]. Title will be deleted.

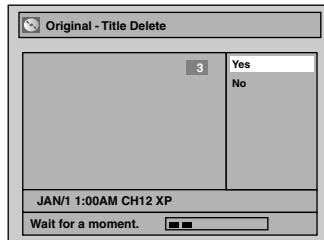

6
After this operation is completed, press [SETUP] to exit. Writing the data on the disc will start momentarily.

This operation may take a while to be completed.

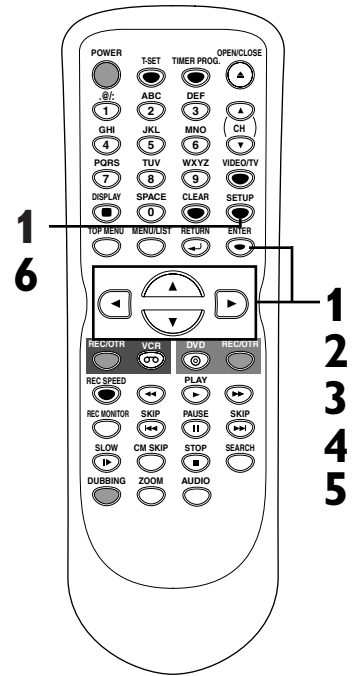

Note

- When a title is deleted from an original list, corresponding title on the Playlist(s) will be also deleted.

Editing

Editing discs in VR mode (Original) (cont'd)

Setting titles to protect



To prevent accidental editing or title erasing, you can protect the contents in the original menu.

First: 

1

Follow steps 1 to 3 on page 57 to display the Original menu.

Using [\blacktriangle / \blacktriangledown], select “Protect”. Press [ENTER].

Confirmation window will appear.

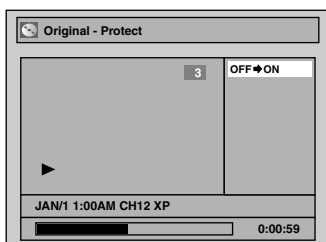

2

Confirm the indication “OFF → ON”. Press [ENTER].

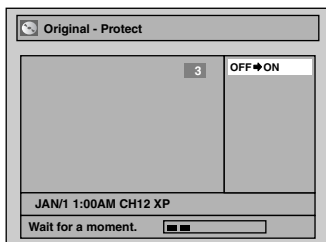

The key icon will appear on the title in the original list.

3

After this operation is completed, press [SETUP] to exit.

Writing the data on the disc will start momentarily.

This operation may take a while to be completed.

To protect a whole disc (DVD-RW VR mode Only) :

Select “Disc Protect” from Disc menu, then select “Yes”.

Refer to “Setting a disc to protect” on page 35.

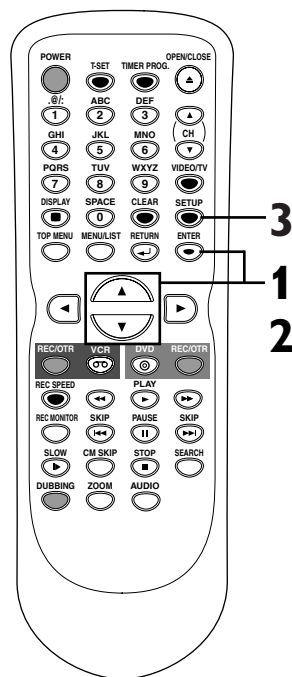

Note

- The protected title will be marked with a key icon on the original list.

Releasing titles from protecting



You can cancel the title-protecting.

First: 

1

Follow steps 1 to 3 on page 57 to display the Original menu.

A “” icon is shown on the protected titles.
“Protect” is already highlighted.

Press **[ENTER]**.

Confirmation window will appear.

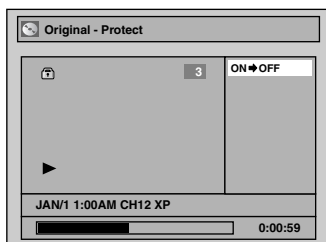

2

Confirm the indication “ON → OFF”. Press **[ENTER]**.

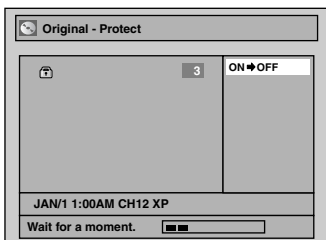

The key icon will disappear from the title in the original list.

3

After this operation is completed, press **[SETUP]** to exit.

Writing the data on the disc will start momentarily.

This operation may take a while to be completed.

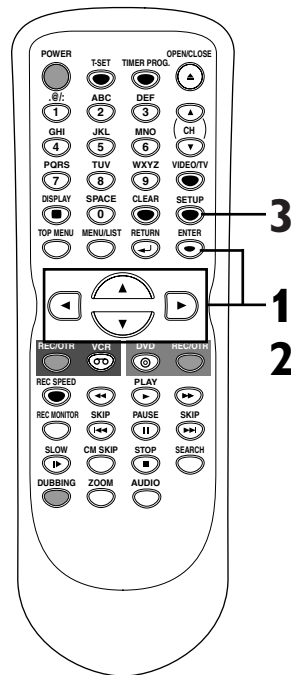

Editing discs in VR mode (Playlist)

Deleting titles



In VR mode, even if a title is deleted from a Playlist, the original title will remain on the Original list, and recordable disc space will not increase.

First: 

1

Press [SETUP]. Using [◀/▶], select “Disc”. Press [ENTER].

Disc menu will appear.

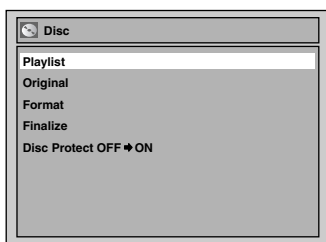

2

Using [▲/▼], select “Playlist”. Press [ENTER].

Playlist will appear.

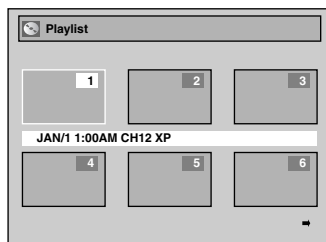

3

Using [▲/▼/◀/▶], select a desired title. Press [ENTER].

Playlist menu will appear.

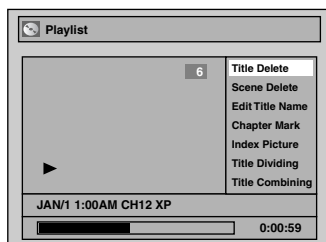

4

Using [▲/▼], select “Title Delete”. Press [ENTER].

Confirmation window will appear.

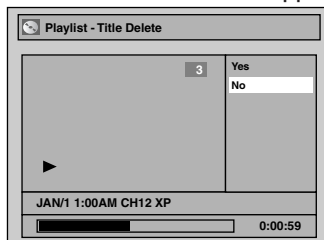

5

Using [▲/▼], select “Yes”. Press [ENTER].

Title will be deleted.

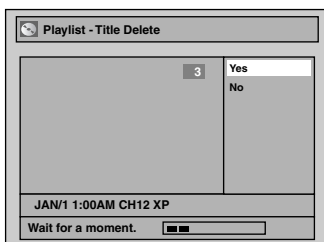

6

After this operation is completed, press [SETUP] to exit.

Writing the data on the disc will start momentarily.

This operation may take a while to be completed.

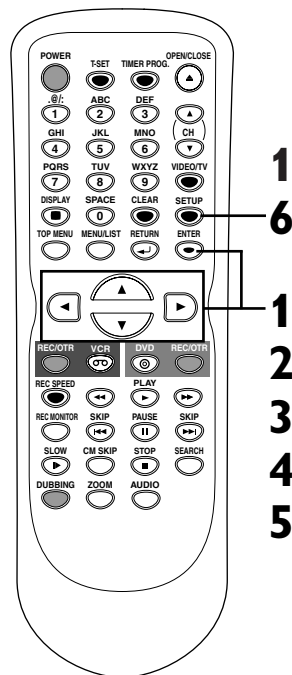

Editing discs in VR mode (Playlist) (cont'd)

Deleting parts of titles



You can delete a specific part of a title.

Even if a part of a title is deleted from the playlist, the original title will remain as it was, and recordable disc space will not increase.

First:

1 Follow steps 1 to 3 on page 60 to display the Playlist menu.

Using **[▲ / ▼]**, select “Scene Delete”. Press **[ENTER]**.

Option window will appear.

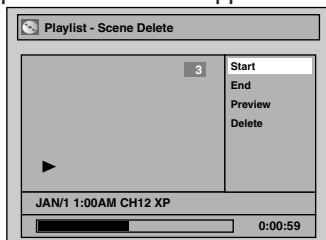

2

Use **[SKIP ◀◀ / ▶▶]**, **[◀◀]**, **[▶▶]** **[PLAY ▶]** and **[PAUSE ||]** to decide the start point, then press **[ENTER]**. Then use **[SKIP ◀◀ / ▶▶]**, **[◀◀]**, **[▶▶]**, **[PLAY ▶]** and **[PAUSE ||]** again to move to the end point and press **[ENTER]**.

The cursor will move to “Preview.”

The bar at the bottom of the screen indicates the total and the elapsed time of the title. The area selected for deletion will be indicated in red during the preview.

Press **[ENTER]** again to start the preview.

You can check the result of the deletion by preview.

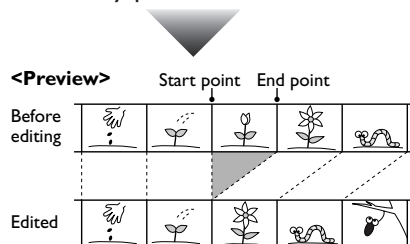

3

Using **[▲ / ▼]**, select “Delete”. Press **[ENTER]**.

Confirmation window will appear.

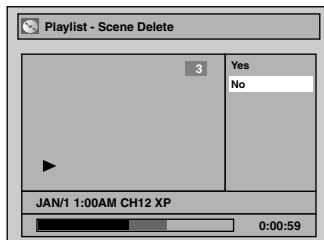

4

Using **[▲ / ▼]**, select “Yes”. Press **[ENTER]**.

Part of a title will be deleted.

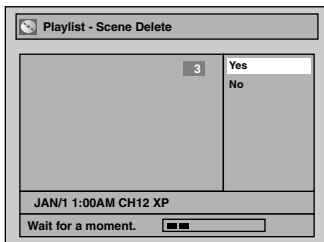

5

After this operation is completed, press **[SETUP]** to exit.

Data will be written onto the disc momentarily.

This operation may take a while to be completed.

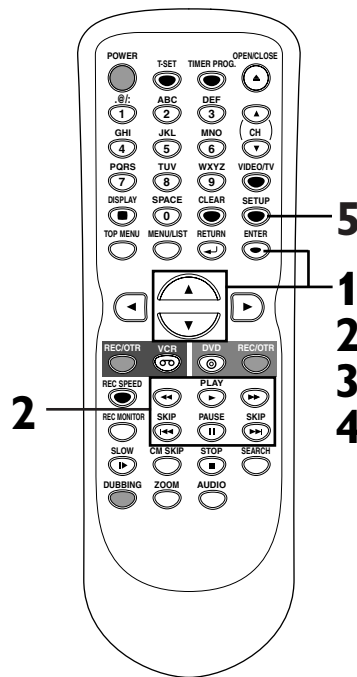

Note

- You cannot select “Scene Delete” when the number of chapter markers exceeds 900.

Editing

Editing discs in VR mode (Playlist) (cont'd)

Putting names on titles



You can name titles and change the names in this menu. The names you put on the titles will be displayed on a title list.

First: 

1
Follow steps 1 to 3 on page 60 to display the Playlist menu.

Using **[▲ / ▼]**, select **"Edit Title Name"**. Press **[ENTER]**. A window for entering a title name will appear.

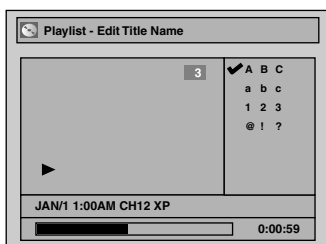

2
To enter a title name, follow the steps of **"Guide to edit title name"** on this page.

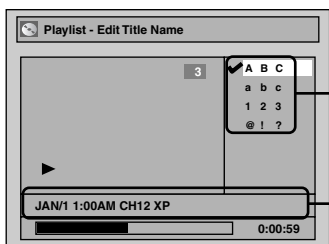

area for entering title names

When you finish entering a title name, press **[ENTER]**. Confirmation window will appear.

3
Using **[▲ / ▼]**, select **"Yes"**. Press **[ENTER]**.

The name you entered will be activated.

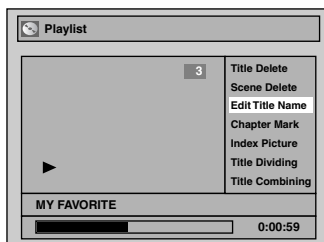

4
After this operation is completed, press **[SETUP]** to exit. Writing the data on the disc will start momentarily.

This operation may take a while to be completed.

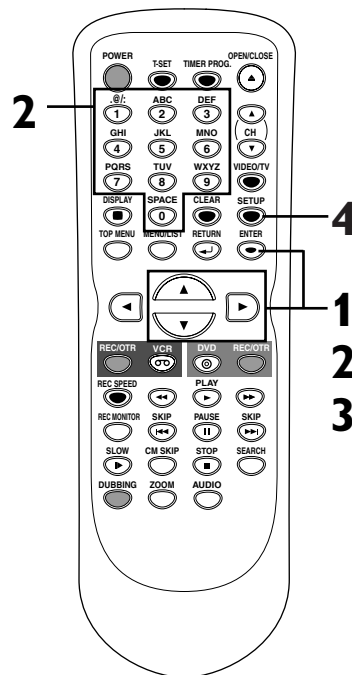

[Guide to edit title name]

[Step1]: Select a desired character set using **[▲/▼]**, then press **[ENTER]**.

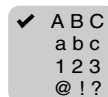

[Step2]: Follow the list below, press the **Number buttons** repeatedly until the desired letter appears.
e.g. character set : **A B C**

Select	ABC	abc	123	@!?
0	<space>	<space>	0	<space>
1	-	-	1	!"#\$%&'()* *+,-./:;<=> ?@[]^_{ }
2	ABC	abc	2	-
3	DEF	def	3	-
4	GHI	ghi	4	-
5	JKL	jkl	5	-
6	MNO	mno	6	-
7	PQRS	pqrs	7	-
8	TUV	tuv	8	-
9	WXYZ	wxyz	9	-

Note:
Undefined letters in a title name are shown by **"*"**. If you delete them, adjoining letters may change to **"*"** or other.

- Character set will be changed to the **"@!?"** automatically if you press **1** after you selected the **"ABC"** or **"abc"** mode.
- If you want to mix different character sets in one title, repeat Step [1] and [2] above.
- To delete letters, press **[CLEAR]** repeatedly. Hold **[CLEAR]** to delete all letters.
- To go on to the next entering area for letters, press **[▶]**.
- You can enter up to 30 letters.

Setting or clearing chapter markers



You can put chapter markers on each title and can use them for the chapter search.

You can put a chapter marker anywhere you want until the total number of the markers reaches 999.

First: 

1

Follow steps 1 to 3 on page 60 to display the Playlist menu.

Using **[▲ / ▼]**, select **“Chapter Mark”**. Press **[ENTER]**.

Option window will appear.

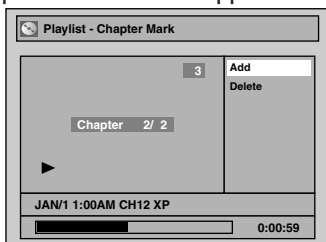

2

Use **[SKIP ◀◀ / ▶▶]**, **[◀◀]**, **[▶▶]**, **[PLAY ▶]** and **[PAUSE II]** to decide the point for a new chapter marker. Or, use **[SKIP ◀◀ / ▶▶]** to decide a chapter marker that you will delete. Select **“Add”** or **“Delete”** accordingly using **[▲ / ▼]**, then press **[ENTER]**.

Confirmation window will appear.

<Add>:

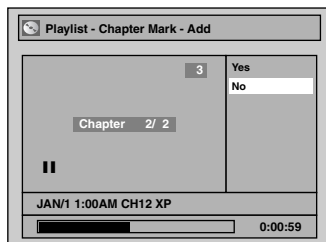

<Delete>:

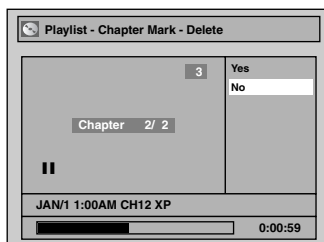

- You cannot delete the first chapter of each title.

3

Using **[▲ / ▼]**, select **“Yes”**.

Press **[ENTER]**.

When you select **“Add”** at step 2, a new chapter marker will be added at the point you have decided.

<Add>:

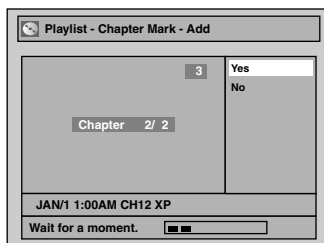

When you select **“Delete”** at step 2, the chapter marker you have selected will be deleted.

<Delete>:

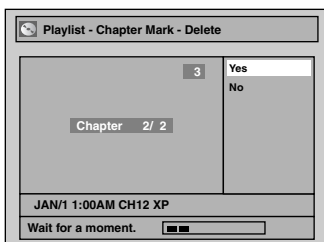

4

After this operation is completed, press **[SETUP]** to exit.

Writing the data on the disc will start momentarily.

This operation may take a while to be completed.

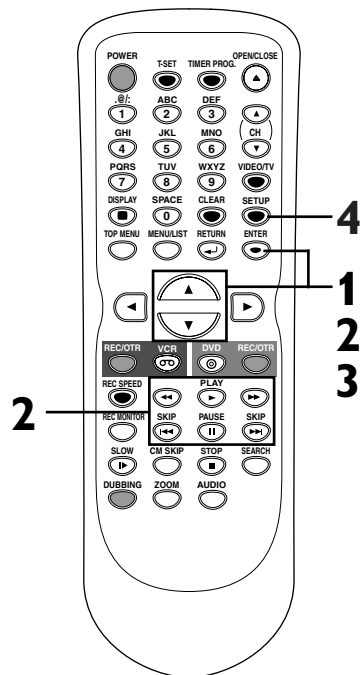

Editing discs in VR mode (Playlist) (cont'd)

Setting pictures for thumbnails



You can set an image picture for each title as a thumbnail. It helps you remember the contents of the title during playback. The default setting chooses the first scene of each title as the thumbnail.

First: 

1

Follow steps 1 to 3 on page 60 to display the Playlist menu.

Using [**▲** / **▼**], select “Index Picture Set”. Press [**ENTER**].

Use [**SKIP** **◀◀** / **▶▶**], [**◀◀**], [**▶▶**], [**PLAY** **▶**] and [**PAUSE** **||**] to decide the picture you want to select as thumbnail. Then press [**ENTER**].

Confirmation window will appear.

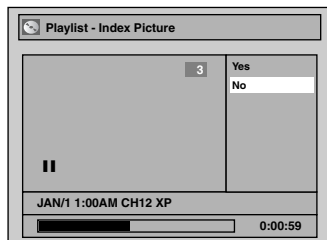

2

Using [**▲** / **▼**], select “Yes”. Press [**ENTER**].

A picture for thumbnail will be set.

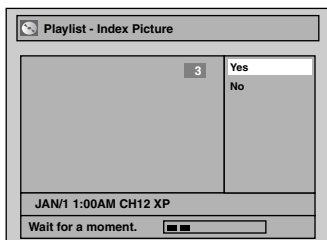

3

After this operation is completed, press [**SETUP**] to exit.

Writing the data on the disc will start momentarily.

This operation may take a while to be completed.

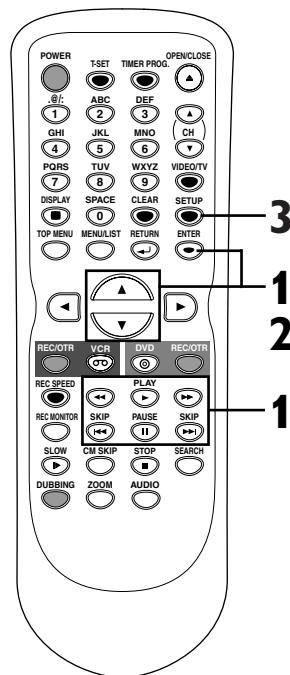

Note

- If a selected picture as thumbnail is deleted by deleting a part of a title, a default picture will automatically replace it.

Dividing a title



You can divide a title into two new titles.

First: 

1

Follow steps 1 to 3 on page 60 to display the Playlist menu.

Use [SKIP ◀◀ / ▶▶], [◀◀], [▶▶], [PLAY ▶] and [PAUSE II] to decide the point at which you will divide the title.

Using [▲ / ▼], select "Title Dividing". Press [ENTER].

Confirmation window will appear.

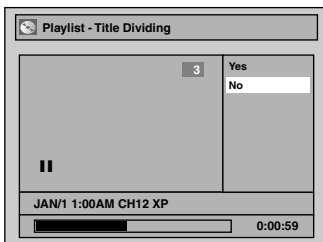

2

Using [▲ / ▼], select "Yes". Press [ENTER].

The title will be divided into two new titles.

Both title names are identical and index pictures are reset to the first scene of each title.

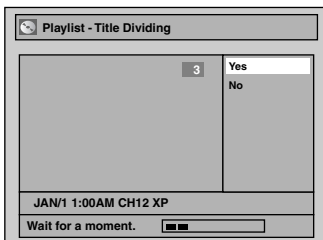

3

After this operation is completed, press [SETUP] to exit.

Writing the data on the disc will start momentarily.

This operation may take a while to be completed.

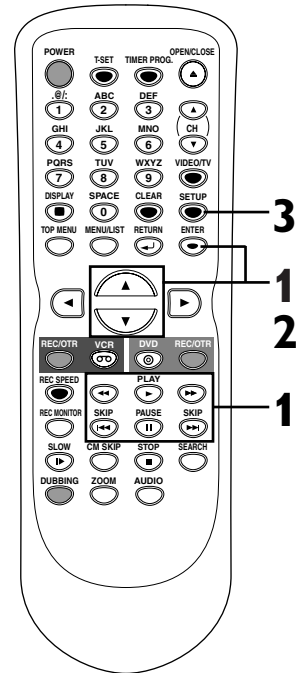

Note

- If a disc contains the maximum number of recordings (99), you cannot divide any titles.
- You cannot divide the titles if the total number of the chapters have already reached 999.

Editing

Editing discs in VR mode (Playlist) (cont'd)

Combining titles



You can combine two titles into a single title.

First: 

1

Follow steps 1 to 3 on page 60 to display the Playlist menu.

Using [\blacktriangle / \blacktriangledown], select “Title Combining”. Press [ENTER].

Title Combining setting window will appear.

The selected title will be grayed out, and the frame of the next title becomes yellow.

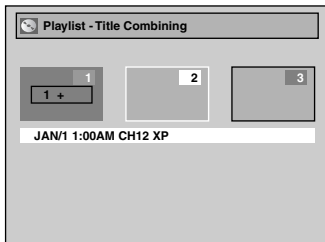

2

Using [\blacktriangle / \blacktriangledown / \blacktriangleleft / \blacktriangleright], select another title to combine.

Press [ENTER].

Confirmation window will appear.

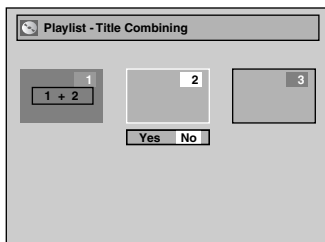

3

Using [\blacktriangle / \blacktriangledown], select “Yes”. Press [ENTER].

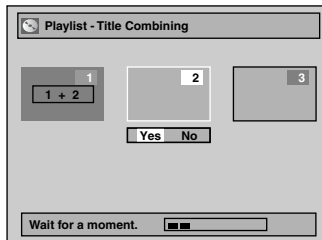

Two titles will be combined into a single title.

4

After this operation is completed, press [SETUP] to exit.

Writing the data on the disc will start momentarily.

This operation may take a while to be completed.

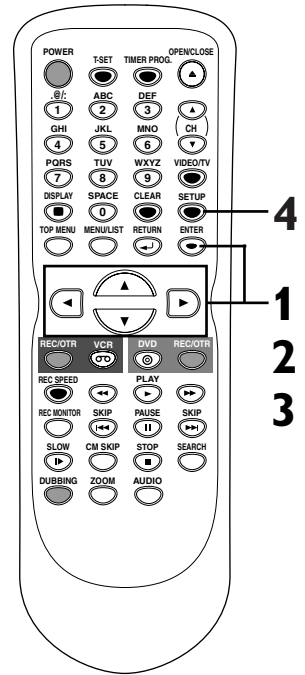

Note

- If the number of chapter markers in the combined title exceeds 999, the combination will be rejected.
- If one of two titles in the original is deleted, the combined new title will be deleted.
- The name of the title selected first will become the name of the combined title.
- The title selected first will be the first point of the combined title.

Editing

Editing discs in VR mode (Playlist) (cont'd)

Adding titles to a Playlist



You can add or delete a title on the playlist as you prefer. You can add up to 99 titles to a Playlist.



1

Follow steps 1 to 2 on page 60 to display the Playlist. "Add New Title" "Delete Playlist" menu will appear next to the last title.

Using [\blacktriangle / \blacktriangledown / \blacktriangleleft / \blacktriangleright], select "Add New Title". Press [ENTER].

Original list will appear.

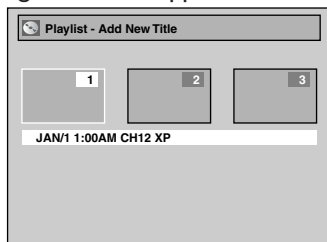

2

Using [\blacktriangle / \blacktriangledown / \blacktriangleleft / \blacktriangleright], select a desired title. Press [ENTER].



The selected title will appear to the Playlist.

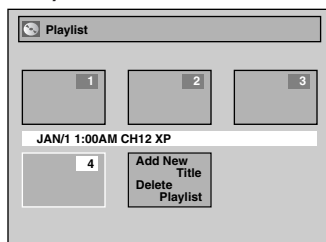

3

After this operation is completed, press [SETUP] to exit.

Writing the data on the disc will start momentarily.

This operation may take a while to be completed.

Deleting a Playlist



A Playlist can be deleted if it is no longer needed.



1

Follow steps 1 to 2 on page 60 to display the Playlist. "Add New Title" "Delete Playlist" menu will appear next to the last title.

Using [\blacktriangle / \blacktriangledown / \blacktriangleleft / \blacktriangleright], select "Delete Playlist". Press [ENTER].

Confirmation window will appear.

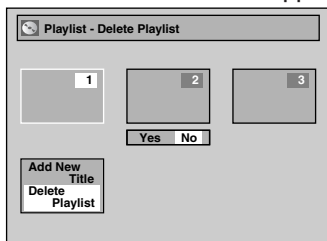

2

Using [\blacktriangleleft / \blacktriangleright], select "Yes". Press [ENTER].

A Playlist will be deleted.

3

After this operation is completed, press [SETUP] to exit.

Writing the data on the disc will start momentarily.

This operation may take a while to be completed.

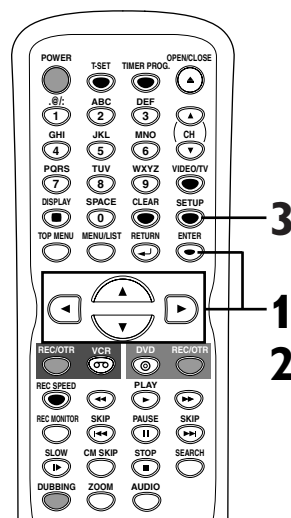

Note

- When a Playlist contains 99 titles or more or 999 chapters or more, "Add New Title" cannot be selected.
- To delete a title from Playlist, refer to "Deleting titles" on page 60.
- To delete a Playlist, refer to "Deleting a Playlist" on this page.

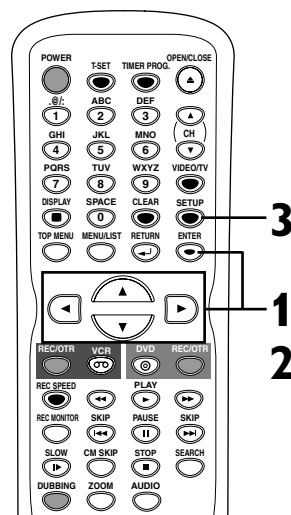

Note

- Deleting a Playlist will not increase the recordable disc space.

Changing the Setting menu

Tour of the Setting menu

The following table shows the items which you can change the setting and their default settings. Refer to the following table for your convenience.

Setting menu	Items (highlight is the default)	Contents	
1. Language setting ➡ Pages 69-70	Disc Menu Language	English French Spanish ⋮	Set the language for disc menu.
	Audio Language	Original English French ⋮	Set the language for audio.
	Subtitle Language	OFF English French ⋮	Set the language for subtitles.
2. Display setting ➡ Pages 70-71	OSD Language	English Français Español	Set the language for OSD (On-Screen Display).
	FL Dimmer	Auto Bright Dark	Set the brightness of front display.
	Screen Saver	OFF 5 minutes 10minutes ⋮	Set the idling time before the screen saver starts.
3. Audio setting ➡ Pages 71-73	Digital Out	Dolby Digital PCM Stream	Set the type of sound signal output from the digital audio output jack.
		PCM 48kHz 96kHz	Set whether the sound recorded in 96kHz will be down sampled in 48kHz.
	Dynamic Range Control	ON OFF	Compressing the range of sound volume.
	Fast Forward with Audio	ON OFF	Set whether or not to output sound during fast forward playback.
4. Parental setting ➡ Pages 73-74	Parental Lock	ALL level 8 to 1	Set the parental level for DVD disc playback.
	(Change password)	Enter the current four-digit password	Set and change the password.

Note

- If you change the settings in the Setting menu, the information of contents stays on even after the power is switched off or the disc tray is opened or closed.
- An item which is not currently available is grayed out in Setting menus.

Changing the Setting menu

Language setting

Press **[STOP ■]** if you are playing back a disc.

1

Press **[SETUP]**.

Easy Setting Menu or Advanced Setting Menu will appear.
If Advanced Setting Menu is displayed, proceed to step 3.

2

Using **[▲ / ▼]**, select “Advanced Setting Menu”. Press **[ENTER]**.

Advanced Setting Menu will appear.

3

Using **[▲ / ▼]**, select “Playback”. Press **[ENTER]**.

Option window will appear.

4

Using **[▲ / ▼]**, select a desired item. Press **[ENTER]**.

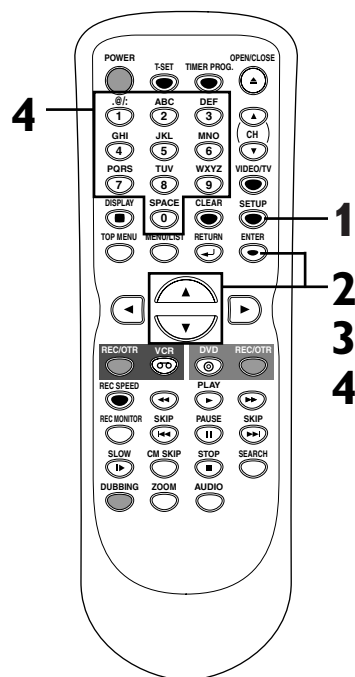

Disc Menu Language (Default : English)

Set the language for Disc Menu.

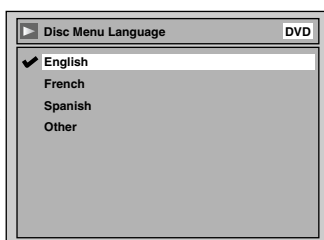
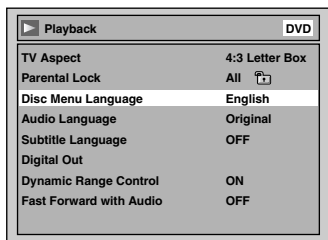

- Using **[▲ / ▼]**, select a language. Press **[ENTER]**.
Your setting will be activated.

Audio Language (Default : Original)

Set the Audio language.

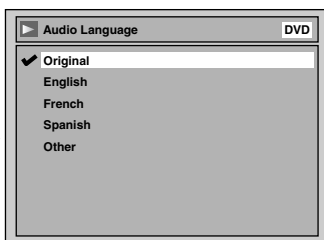
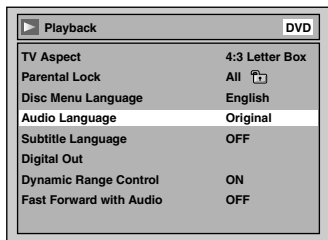

- Using **[▲ / ▼]**, select a setting. Press **[ENTER]**.
Your setting will be activated.
- When Original is selected, the audio language will be the disc's default language.

Instructions continue on the next page.

Changing the Setting menu

Language setting (cont'd)

Subtitle Language (Default : OFF)

Set the Subtitle language.

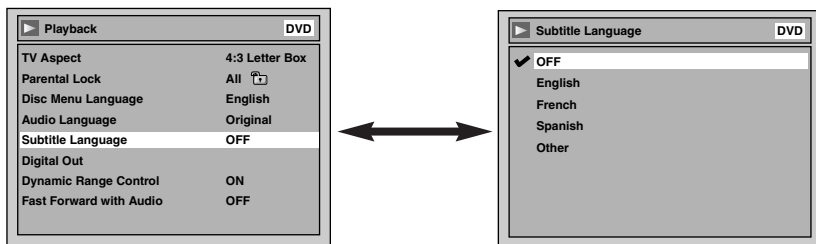

• Using [▲ / ▼], select a language. Press [ENTER].

Your setting will be activated.

If “Other” is selected, enter 4-digit code using the Number buttons.

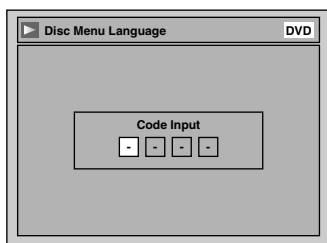

• When you finish entering the code, press [ENTER]. Refer to the language code table on page 82.

Note

- Only the languages supported by the disc can be selected.
- Audio Language setting may not be available on some discs.
- You can also change or switch off the subtitles on a DVD disc also from the disc menu if it is available.
- Press [CLEAR] or [◀] to erase numbers entered incorrectly.

5

Press [SETUP] to exit.

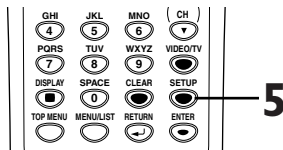

Display setting

Press [STOP ■] if you are playing back a disc.

1

Press [SETUP].

Easy Setting Menu or Advanced Setting Menu will appear. If Advanced Setting Menu is displayed, proceed to step 3.

2

Using [▲ / ▼], select “Advanced Setting Menu”. Press [ENTER].

Advanced Setting Menu will appear.

3

Using [▲ / ▼], select “Display”. Press [ENTER].

Option window will appear.

4

Using [▲ / ▼], select a desired item. Press [ENTER].

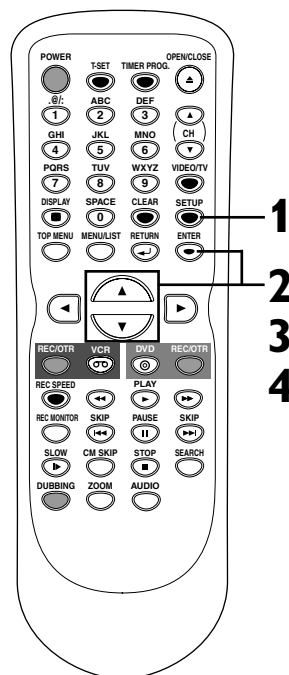

Changing the Setting menu

Display setting (cont'd)

OSD Language (Default : English)

Set the language for OSD.

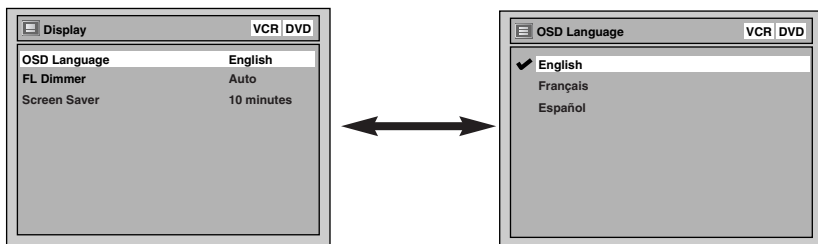

- Using [▲ / ▼], select a language. Press [ENTER].

Your setting will be activated.

FL Dimmer (Default : Bright)

Set the brightness of front display.

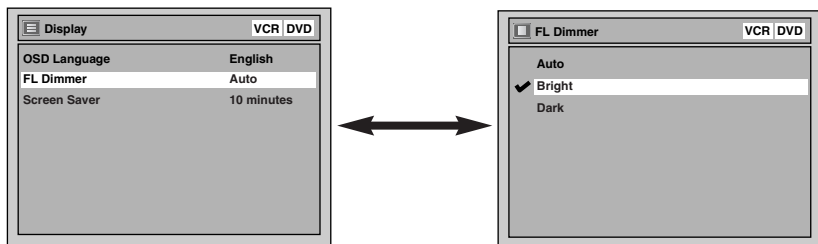

- Using [▲ / ▼], select a setting. Press [ENTER].

Your setting will be activated.

- You can choose one among "Auto", "Bright" and "Dark".

When "Auto" is selected, the display will be shown brighter when the power is on and darker when the power is off.

Screen Saver (Default : 10 minutes)

Set the the idling time before the screen saver starts.

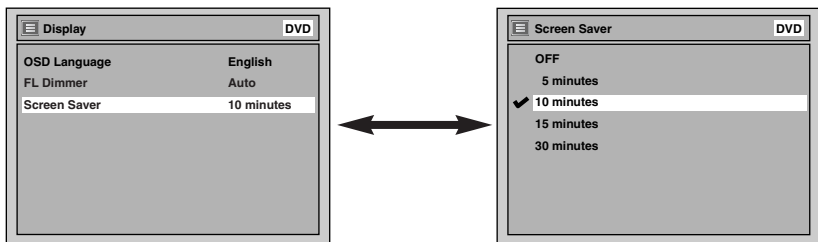

- Using [▲ / ▼], select a setting. Press [ENTER].

Your setting will be activated.

5

Press [SETUP] to exit.

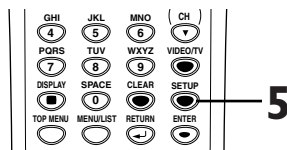

Audio setting

Choose the appropriate Audio settings for your equipment.

Press [STOP ■] if you are playing back a disc.

1

Press [SETUP].

Easy Setting Menu or Advanced Setting Menu will appear. If Advanced Setting Menu is displayed, proceed to step 3.

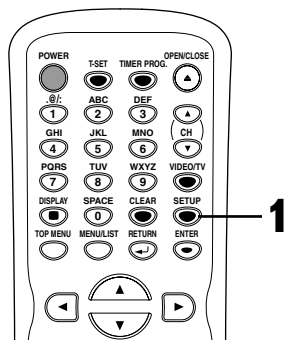

Instructions continue on the next page.

Changing the Setting menu

Audio setting (cont'd)

2

Using [▲ / ▼], select “Advanced Setting Menu”. Press [ENTER].

Advanced Setting Menu will appear.

3

Using [▲ / ▼], select “Playback”. Press [ENTER].

Option window will appear.

4

Using [▲ / ▼], select a desired item. Press [ENTER].

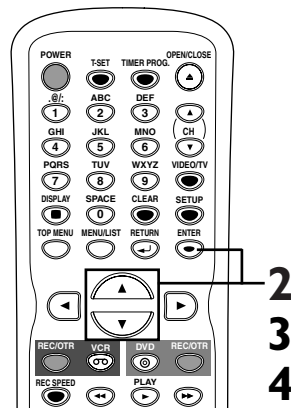

Note

- Dynamic Range Control is available only on the discs which are recorded in Dolby Digital format.

Digital Out

Set the digital audio output.

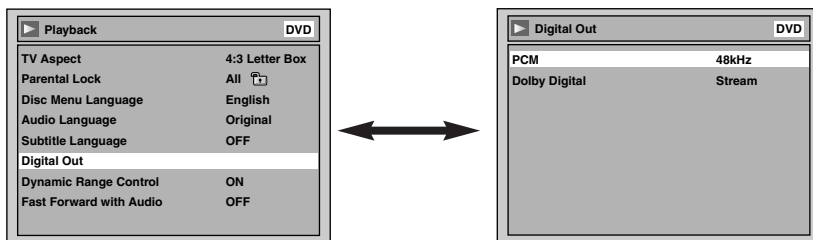

- Using [▲ / ▼], select a setting. Press [ENTER]. Option window will appear. Proceed to steps A or B.

A

Settings for PCM (Default : 48kHz)

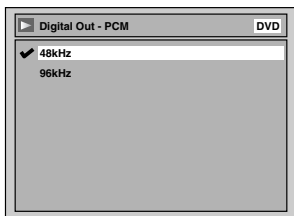

• Using [▲ / ▼], select a setting. Press [ENTER].

Your setting will be activated.

48kHz : If your amplifier/decoder is NOT compatible with 96kHz PCM, select “48kHz”. 96kHz sound will be output in 48kHz.

96kHz : If your amplifier/decoder is compatible with 96kHz PCM, select “96kHz”. 96kHz sound will be output.

Note

When playing back disc with copyright protection

- Even if you select “96kHz”, the sound will be down sampled at 48kHz.

B

Settings for Dolby Digital (Default : Stream)

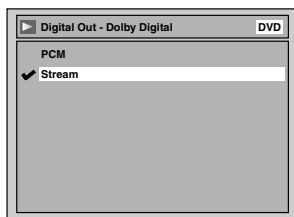

• Using [▲ / ▼], select a setting. Press [ENTER].

Your setting will be activated.

PCM : Convert the Dolby Digital into PCM (2 channel).

When your amplifier/decoder is NOT compatible with Dolby Digital, set to “PCM”.

Stream : Outputs Dolby Digital signals.

When your amplifier/decoder is compatible with Dolby Digital, set to “Stream”.

Note

When playing back a DVD-RW disc recorded in VR mode

- If the audio on a disc is recorded in Dolby Digital format, set “Dolby Digital” to “PCM” so that you can switch to main (L), sub audio (R), or a mix of both (L/R) with your amplifier/decoder.

Changing the Setting menu

Audio setting (cont'd)

Dynamic Range Control (Default : ON)

Set to "ON" to compress the range between soft and loud sounds.

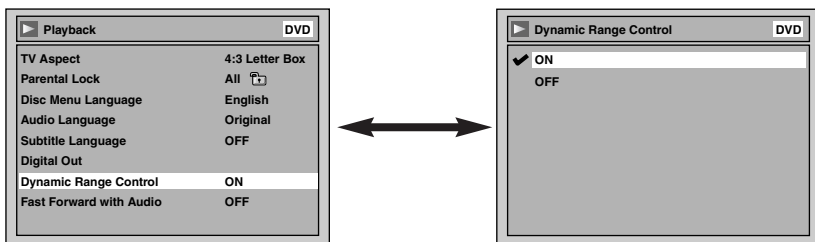

• Using [▲ / ▼], select a setting. Press [ENTER].
Your setting will be activated.

Fast Forward with Audio (Default : OFF)

Set to "ON" to output the sound during playback in x1.5 fast forward.

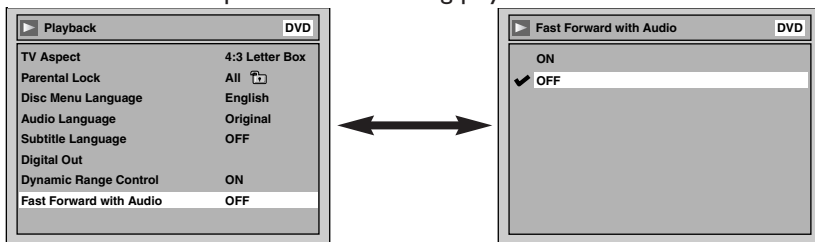

• Using [▲ / ▼], select a setting. Press [ENTER].
Your setting will be activated.

5

Press [SETUP] to exit.



Settings for Parental lock level

Some DVD-Video discs feature a Parental Lock level. Playback will stop if the disc's general rating exceeds the level you set. It will require you to enter a password before the disc will be played back. This function prevents your children from viewing inappropriate materials.

Press [STOP ■] if you are playing a disc.

1

Press [SETUP].

Easy Setting Menu or Advanced Setting Menu will appear. If Advanced Setting Menu is displayed, proceed to step 3.

2

Using [▲ / ▼], select "Advanced Setting Menu". Press [ENTER].

Advanced Setting Menu will appear.

3

Using [▲ / ▼], select "Playback". Press [ENTER].
Option window will appear.

4

Using [▲ / ▼], select "Parental Lock". Press [ENTER].

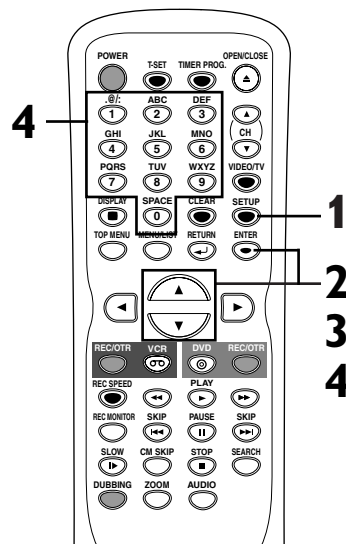

Note

- Parental lock may not be available on some discs.
- For some DVDs, it may be difficult to find if they are compatible with parental lock. Be sure to check if the parental lock operates in the way that you have set.
- Record the password in case you forget it.

Instructions continue on the next page.

Changing the Setting menu

Settings for Parental lock level (cont'd)

Parental Lock (Default :All)

Set the Parental Lock level.

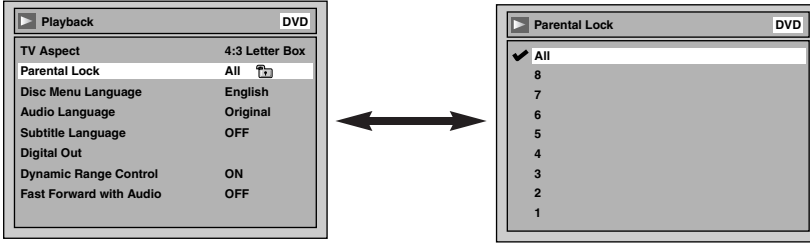

• Using [▲ / ▼], change the parental level. Press [ENTER].

Option window will appear. Proceed to step A or B.

A A password has not been set yet

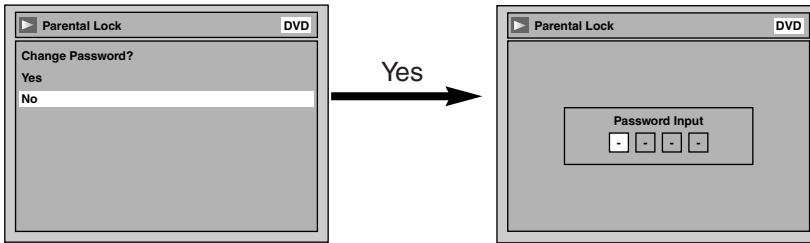

• Using [▲ / ▼], select “Yes”. Using the Number buttons, enter a new password. Press [ENTER].

Your setting will be activated.

• If you select “No”, proceed to step 5.

B A password has been set already

Change the password

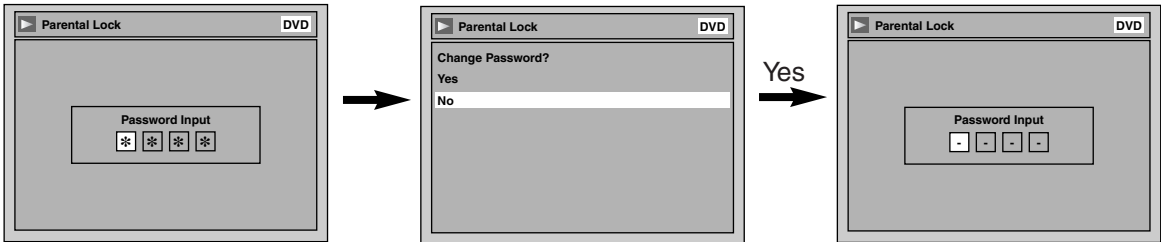

• Using the Number buttons, enter the current password.

• If you select “No”, proceed to step 5.

• Using [▲ / ▼], select “Yes”. Using the Number buttons, enter a new password. Press [ENTER].

Your setting will be activated.

5
Press [SETUP] to exit.

Note

- Press [CLEAR] to erase numbers entered incorrectly.
- Do not use 4, 7, 3, 7 as password.
- When you forget the password or you want to clear all settings in Parental lock, enter 4,7,3,7 using the **Number buttons** in input window at step B. Password will be cleared and parental levels will be set to All.

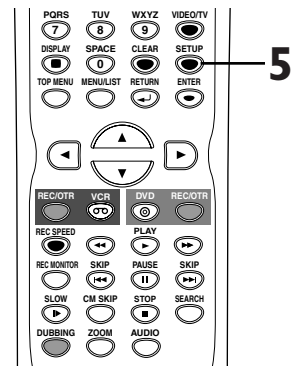

VCR functions

Playback



1

Press **[POWER]** on the remote control or the front panel of the unit.

When you are playing a videotape, turn the TV on and be sure to select the input to which the unit is connected.

Press:

2

Insert a prerecorded videotape. Press **[PLAY ▶]** to begin playback.

3

During playback, press **[PAUSE II]**.

Playback will pause and sound will be muted.

4

Press **[PLAY ▶]** to resume play.

5

Press **[STOP ■]** to stop playback.

6

Press **[STOP ■ / EJECT ▲]** on the front panel of the unit to eject the videotape.

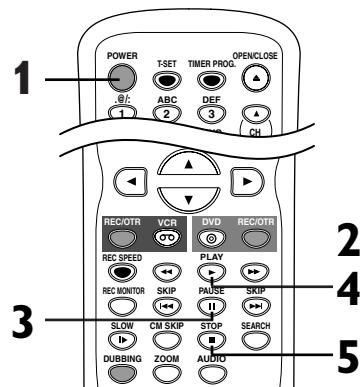

Note

- When a videotape without record tab is inserted, the unit will start playback automatically.
- Tracking will be automatically adjusted upon playback. To adjust the tracking manually, use **[CHANNEL ▲ / ▼]** on the front panel of the unit or **[CH ▲ / ▼]** on the remote control.

Recording and One-touch Timer Recording

Recording



Before recording, make sure:

- The desired channel is selected by using the **Number buttons** on the remote control or **[CHANNEL ▲ / ▼]** on the front panel of the unit.
- There is a videotape with a record tab in the unit.
- The desired recording speed is selected in SP (standard play) or SLP (super long play) mode by pressing **[REC SPEED]** on the remote control.

Recording speed:

Tape speed	Recording/Playback Time		
	Type of tape	T60	T120
SP mode	1hour	2hours	2-2/3hours
SLP mode	3hours	6hours	8hours

- Stereo or SAP is selected. Refer to page 21.
- Refer to page 31 for instructions on Timer Recording.

1

Press **[REC/OTR (VCR)]** to begin the recording.

To temporarily stop recording or to resume it, press **[PAUSE II]**. After the unit has been in Pause mode for 5 minutes, it will stop automatically to protect the videotape and the video head from damage.

2

Press **[STOP ■]** when the recording is completed.

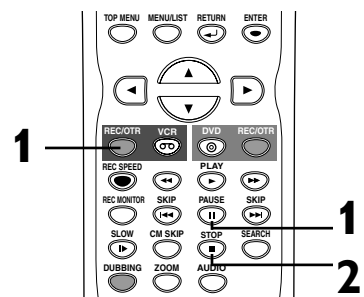

Note

- To view one channel while recording another
 - 1) While you are recording on the unit, press **[VIDEO/TV]**.
 - 2) At the cable box or satellite box, select the channel you want to view.
 If you have connected the unit to a cable box or satellite box, refer to "Connection to a cable box or satellite box" section on page 15.

Accidental erasure prevention

To prevent accidental recording on a recorded videotape, remove its record tab. To record on it later, cover the hole with cellophane tape.

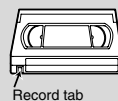

VCR functions

Recording and One-touch Timer Recording (cont'd)

One-touch Timer Recording



This function allows you to set the recording length simply by pressing **[REC/OTR]** (VCR) on the remote control or **[RECORD]** (VCR) on the front panel of the unit.

1

During normal recording, press **[REC/OTR]** (VCR) to begin one-touch Timer Recording.

You can select a fixed recording time by pressing **[REC/OTR]** (VCR) repeatedly.

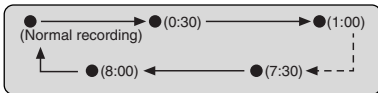

When one-touch Timer Recording is finished, the unit will turn off automatically.

To change the recording length during the one-touch Timer Recording, press **[REC/OTR]** (VCR) repeatedly until the desired length appear.

To cancel the one-touch Timer Recording within the specified time, press **[STOP ■]**.

Note

- The remaining recording time will appear on the display panel during an one-touch Timer Recording. Press **[DISPLAY]** to see it on the TV screen.
- You cannot pause a one-touch Timer Recording.
- If OTR is finished in VCR during playback or REC mode in DVD, the VCR will be in STOP mode and the DVD keeps the current mode.

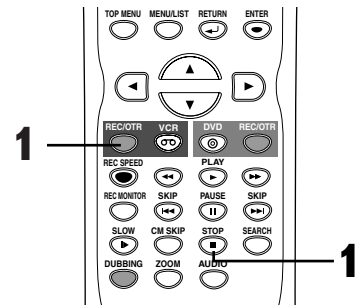

- Unlike a Timer Recording, you can perform the following operations during a one-touch Timer Recording.
 - Turning the power off
 - Using **[REC/OTR]** (VCR) or **[STOP ■]**.
- When OTR is finished and the power is turned off, the unit will switch to the standby mode automatically if a Timer Recording has been programmed. Press **[T-SET]** to cancel the standby mode for using the unit continuously.

Search

Index search



An index mark will be assigned at the beginning of each recording you make. You may skip to a specific marked point by following the steps below.

First:

1

Press **[SEARCH]** so that the index search menu appears.

2

Using the Number buttons, enter the number of recordings you wish to skip with in 30 seconds.

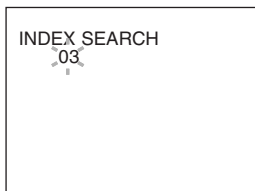

3

Press **[>>> / <<<]** to start index search.

If you want to go in the forward direction, press **[>>>]**.

If you want to go in the reverse direction, press **[<<<]**.

After index search, the VCR will play the videotape automatically.

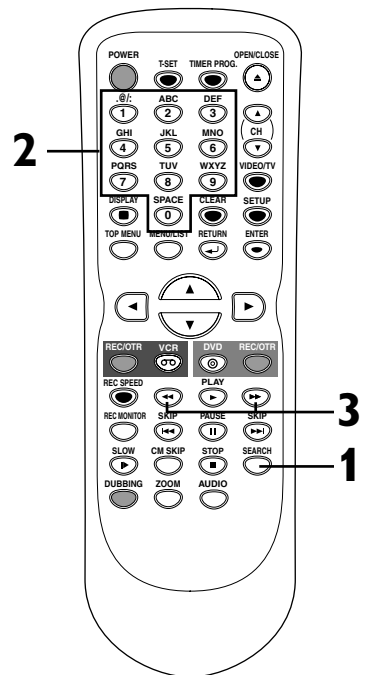
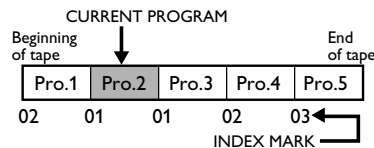

Note

- Every time a videotape is recorded, an index mark is written on the videotape.

VCR functions

Search (cont'd)

Time search



This function allows you to go to a specific point on a videotape by entering the exact amount of time you wish to skip in order to reach the point.

First:

TIME SEARCH
2:50

1

Press **[SEARCH]** repeatedly so that the Time search menu appears.

2

Using the Number buttons, enter your desired time to skip with in 30 seconds.

3

Use **[▶▶/◀◀]** to start time search.

If you want to go in the forward direction, press **[▶▶]**.

If you want to go in the reverse direction, press **[◀◀]**.

After time search, the unit will play the videotape automatically.

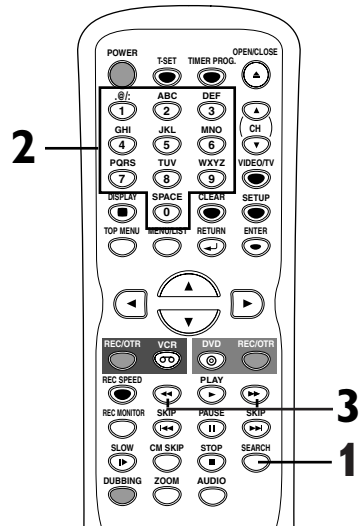

Note

- Index search and Time search are not available during recording.
- Press **[STOP ■]** to stop the search.
- If the end of the videotape is reached during a Search, this unit will cancel the search and rewind the videotape.

Other operations



First:

Fast forward:

When the unit is in stop mode, press **[▶▶]** to fast forward the videotape.

Rewind:

When the unit is in stop mode, press **[◀◀]** to rewind the videotape.

To cue or review picture during playback (Picture Search):

Use **[▶▶/◀◀]** during playback.

Press it again and the unit will search in super high speed. (in the SLP mode only)

To freeze the picture on TV screen during playback (Still mode):

Press **[PAUSE II]**. Each time you press the button, the picture will be forwarded by one frame.

If the picture begins to vibrate vertically during the still mode, stabilize the picture by using **[CHANNEL ▲ / ▼]** on the unit or **[CH ▲ / ▼]** on the remote control.

If the picture is distorted or rolling vertically, adjust the vertical hold control on your TV, if equipped.

Counter Reset:

Press **[CLEAR]**.

To playback in slow motion:

Press **[SLOW ▶]** during playback or the still mode.

If the noise bars appear on the TV screen, you can reduce it by using **[CHANNEL ▲ / ▼]** on the unit or **[CH ▲ / ▼]** on the remote control.

Automatic Rewind

When a videotape is played or fast forwarded to its end, the videotape will rewind to the beginning, stop and eject itself.

When you playback a videotape recorded in Hi-Fi stereo:

Press **[AUDIO]** on the remote control to select Hi-Fi or MONO for playback sound mode.

- If you have connected a stereo TV to this unit, select "HIFI".
- If you have connected a monaural TV to this unit, select "MONO".

Note

- Still/Slow/Pause mode will be automatically cancelled after 5 minutes to prevent damage to the videotape and the video head.
- To return to playback from the Picture Search/Still/Slow mode, press **[PLAY ▶]**.

Your Selection	HIFI		MONO
	L-channel	R-channel	
Type of recorded tape	L-channel	R-channel	MONO
non Hi-Fi tapes	Monaural	Monaural	Monaural
Hi-Fi tapes recorded in Hi-Fi stereo	L	R	L+R
Hi-Fi tapes recorded main audio program	Main audio program	Main audio program	Main audio program
Hi-Fi tapes recorded second audio program	Second audio program	Second audio program	Second audio program

Troubleshooting

Before requesting service for this unit, check the table below for a possible cause of the problem you are experiencing. Some simple checks or a minor adjustment on your part may eliminate the problem and restore proper performance.

Symptom	Remedy
The power does not turn on.	<ul style="list-style-type: none"> • Check that the AC power cord is connected securely. • (In case of power failure) Check the breaker. • Press [T-SET] to cancel the timer standby mode.
There is no picture.	<ul style="list-style-type: none"> • Re-connect the connecting cord securely. • The connecting cords are damaged. • Check the connection to your TV (page 14). • Check the RF output channel when you view a TV program using RF connection. • Switch the input selector on your TV (such as to "LINE1") so that the signal from this unit appears on the TV screen.
TV program reception does not fill the screen.	<ul style="list-style-type: none"> • Try to set the channels with "Auto Preset" in the Setting menu (page 19). • Select a channel of any TV program using the [CH ▲ / ▼]. • Press [VIDEO/TV] if necessary.
TV program pictures are distorted.	<ul style="list-style-type: none"> • Adjust TV antenna. • Adjust the picture (see the TV's instruction manual). • Place the unit and TV farther apart. • Place the TV and any bunched antenna cables farther apart.
TV channels cannot be changed.	<ul style="list-style-type: none"> • Switch the input to TV. • Connect the antenna cable correctly (page 14).
Playback picture is distorted.	<ul style="list-style-type: none"> • Keep the equipment which may cause electrical disturbances, such as a cellular phone, away.
The playback picture or TV program from the equipment connected through the unit is distorted.	<ul style="list-style-type: none"> • If the playback picture output from a DVD player, VCR or tuner goes through the unit before reaching your TV, the copy-protection signal applied to some programs could affect picture quality. Disconnect the playback equipment in question and connect it directly to your TV.
There is no sound.	<ul style="list-style-type: none"> • Re-connect all connections securely. • The connecting cord is damaged. • Check the connections to the amplifier input. • The input source setting on the amplifier is incorrect. • The unit is in pause mode or in slow-motion play mode. • The unit is in fast forward or fast reverse mode.
The channel cannot be changed from the channel you are recording.	<ul style="list-style-type: none"> • Set the TV's input to "TV".
Nothing was recorded even though you set the timer setting correctly.	<ul style="list-style-type: none"> • There was a power failure during recording. • The internal clock of the unit stopped due to a power failure that lasted for more than 30 seconds. • Reset the clock (pages 22-24). • Disconnect the AC power cord from the AC outlet, and connect it again. • The program contains copy protection signals that restricts copying. • The timer setting overlapped with another setting that was set later or has priority (page 33).
Timer Recording is not completed or did not start from the beginning.	<ul style="list-style-type: none"> • The timer setting overlapped with another setting that was set later or has priority (page 33). • Disc space was not enough.
Timer Recording is impossible.	<ul style="list-style-type: none"> • Make sure indicator appears on the front display of this unit. If not, press [T-SET].
The remote control does not function.	<ul style="list-style-type: none"> • Batteries are weak. • There are obstacles between the remote control and the unit. • The remote control is far from the unit. • There are no batteries in the remote control. • Turn on the unit. • The remote control is not pointed at the remote sensor on the unit. • Press [DVD] or [VCR], whichever you need. Then, try again. • Press [T-SET] to cancel the timer standby mode.
The unit does not operate properly.	<ul style="list-style-type: none"> • When static electricity, etc., causes the unit to operate abnormally, unplug the unit and then plug it again.

Troubleshooting (cont'd)

Symptom	Remedy
There is no picture.	<ul style="list-style-type: none"> The Setting Menu appears. Press [RETURN ←] (or [SETUP]) to turn off the display.
Picture noise appears.	<ul style="list-style-type: none"> The disc is dirty or flawed. If the picture output signal from the unit passes through your VCR before reaching your TV, or if you are connected to a combination TV/VIDEO player, the copy-protection signal applied to some DVD programs could affect picture quality. If you still experience this problem even when you connect the unit directly to your TV, try connecting the unit to your TV's S-VIDEO input.
There is no sound.	<ul style="list-style-type: none"> If the audio signal does not come through the DIGITAL AUDIO OUT (COAXIAL) jack, check the Audio settings (pages 71-72). The disc is dirty or flawed.
Sound is noisy.	<ul style="list-style-type: none"> The disc is dirty or flawed.
No DTS sound is output.	<ul style="list-style-type: none"> This unit is not compatible with DTS sound.
The unit does not play back the disc.	<ul style="list-style-type: none"> No disc is inserted. A blank disc is inserted. The disc is upside down. Insert the disc with the labeled side facing up. The disc is not correctly inserted. The unit cannot playback certain discs (such as a CD-ROM) (page 40). The region code on the DVD-Video does not match the ones on the unit (page 40). Moisture has condensed inside the unit. Remove the disc and leave the unit turned on for about two hours until the moisture evaporates (page 4). If the disc was recorded on another recorder, the unit cannot play back the disc unless it is finalized (page 36).
Playback image freezes for a second.	<ul style="list-style-type: none"> During the playback of two layered disc, picture may freeze for a moment when the 1st layer switches to the 2nd layer. This is not a malfunction.
The disc does not start playback from the beginning.	<ul style="list-style-type: none"> Resume play was activated (page 44). Press [STOP ■] twice. You have inserted a disc whose Title menu or DVD menu automatically appears on the TV screen when it is first insert.
The unit starts playing back the disc automatically.	<ul style="list-style-type: none"> The DVD-Video provides an auto playback function.
Some functions such as Stop, Search, or Slow-motion Play cannot be performed.	<ul style="list-style-type: none"> Depending on the disc, you may not be able to do some of those operations. See the instruction manual supplied with the disc.
The language for the sound track cannot be changed.	<ul style="list-style-type: none"> Multilingual tracks are not recorded on the DVD-Video, DVD-R or DVD-RW being played back. The DVD-Video prohibits the changing of the language for the sound track. Try changing the language using the DVD-Video's menu.
The subtitle language cannot be changed or turned off.	<ul style="list-style-type: none"> Multilingual subtitle are not recorded on the DVD-Video. The DVD-Video prohibits changing of the subtitles. Try changing the subtitles using the DVD-Video's menu.
The angles cannot be changed.	<ul style="list-style-type: none"> Multi-angles are not recorded on the DVD-Video being played back. The angle-change operation is possible as long as the disc contains a multi-angle portion. Actual change can be performed when the portion has come up. The DVD-Video prohibits changing angles. Try changing the angles using the DVD-Video's menu.
Recording does not stop immediately after you press [STOP ■] .	<ul style="list-style-type: none"> It will take a few seconds for the unit to input disc data before recording can stop.
Recording does not start immediately after you press [REC/OTR] (DVD).	<ul style="list-style-type: none"> An unused DVD-R or DVD-RW was inserted. It takes a while for the unit to automatically format a DVD-RW.
The disc tray does not open when you press [OPEN/CLOSE ▲] .	<ul style="list-style-type: none"> It may take a few seconds for the disc tray to open after you have recorded or edited a disc. This is because the unit is adding disc data to the disc.

DVD

Others

Troubleshooting (cont'd)

Symptom	Remedy
<div style="display: flex; align-items: center;"> <div style="writing-mode: vertical-rl; transform: rotate(180deg); background-color: black; color: white; padding: 5px; margin-right: 5px;">DVD</div> <div> <p>"Repairing" appears on the display.</p>  </div> </div>	<ul style="list-style-type: none"> • If there is a power failure or unplugging during recording, finalizing, formatting or editing (even after "wait for a moment." message is disappeared), a Repairing process will begin automatically soon after turning the unit on again. It may take several minutes up to about four hours.
<div style="display: flex; align-items: center;"> <div style="writing-mode: vertical-rl; transform: rotate(180deg); background-color: black; color: white; padding: 5px; margin-right: 5px;">VCR</div> <div> <p>Picture noise appears.</p> </div> </div>	<ul style="list-style-type: none"> • Head cleaning for VCR may be necessary. Refer to "AUTO HEAD CLEANING". • Adjust tracking control for better picture by using [CHANNEL ▲/▼] on this unit or [CH ▲/▼] while you are playing a videotape.
<div style="display: flex; align-items: center;"> <div style="writing-mode: vertical-rl; transform: rotate(180deg); background-color: black; color: white; padding: 5px; margin-right: 5px;">VCR</div> <div> <p>The tape does not play.</p> </div> </div>	<ul style="list-style-type: none"> • No videotape is inserted.
<div style="display: flex; align-items: center;"> <div style="writing-mode: vertical-rl; transform: rotate(180deg); background-color: black; color: white; padding: 5px; margin-right: 5px;">VCR</div> <div> <p>Recording does not start immediately after you press [REC/OTR] (VCR).</p> </div> </div>	<ul style="list-style-type: none"> • Make sure the videotape has a record tab when you record to a videotape. If needed, cover the hole with cellophane tape.
<div style="display: flex; align-items: center;"> <div style="writing-mode: vertical-rl; transform: rotate(180deg); background-color: black; color: white; padding: 5px; margin-right: 5px;">VCR</div> <div> <p>The remote control does not function.</p> </div> </div>	<ul style="list-style-type: none"> • Check if a videotape is in this unit.
<div style="display: flex; align-items: center;"> <div style="writing-mode: vertical-rl; transform: rotate(180deg); background-color: black; color: white; padding: 5px; margin-right: 5px;">VCR</div> <div> <p>The motor rotates even when playback / recording is stopped.</p> </div> </div>	<ul style="list-style-type: none"> • The motor may rotate for the duration of approximately 5 minutes for efficient operation. This is not a malfunction.

Error message	Cause	Solution
<div style="border: 1px solid black; padding: 2px; text-align: center;">Disc Error</div> <p>— Please eject the disc. — Playback feature may not be available on this Disc.</p>	<p>Unplayable disc is inserted in the unit. The disc is upside down.</p>	<p>Insert the standardized disc which bears the marks on page 40. Insert the disc with the labeled side facing up.</p>
<div style="border: 1px solid black; padding: 2px; text-align: center;">Region Error</div> <p>— Please eject the disc. — Playback is not authorized in your region.</p>	<p>The region of the DVD-Video disc does not match the ones on the unit.</p>	<p>Insert the DVD-Video disc with region code 1 or ALL.</p>
<div style="border: 1px solid black; padding: 2px; text-align: center;">Parental Lock On</div> <p>The current selected parental level prohibits playback.</p>	<p>The current selected parental level in the Setting Menu prohibits playback.</p>	<p>Check the "Parental Lock" setting (pages 73-74).</p>
<div style="border: 1px solid black; padding: 2px; text-align: center;">Recording Error</div> <p>This program is not allowed to be recorded.</p>	<p>The recording function encountered a copy prohibited program.</p>	<p>You cannot record copy prohibited programs.</p>
<div style="border: 1px solid black; padding: 2px; text-align: center;">Recording Error</div> <p>This program is not recordable in Video mode.</p>	<p>You are trying to record a copy-once program onto the DVD-RW disc in Video mode.</p>	<p>Set "DVD-RW Recording Format" to "VR mode" (page 27).</p>
<div style="border: 1px solid black; padding: 2px; text-align: center;">Recording Error</div> <p>Can not record on this disc.</p>	<p>You are trying to record onto the disc which is unrecordable, or the disc status is unable to record. The disc is dirty. The disc is damaged.</p>	<p>Insert a recordable disc, and ensure the disc status satisfies the recording requirements (pages 25-26). Clean the disc with a cleaning cloth. Replace the disc.</p>
<div style="border: 1px solid black; padding: 2px; text-align: center;">Recording Error</div> <p>This program is not allowed to be recorded on this disc.</p>	<p>You are trying to record a copy-once program onto the DVD-RW disc which is not compatible with CPRM.</p>	<p>Insert a ver.1.1 or 1.2 CPRM compatible DVD-RW disc.</p>
<div style="border: 1px solid black; padding: 2px; text-align: center;">Recording Error</div> <p>This disc is protected and not recordable.</p>	<p>You are trying to record on the protected disc.</p>	<p>Cancel the disc protect setting in the Disc Setting menu (page 35).</p>
<div style="border: 1px solid black; padding: 2px; text-align: center;">Recording Error</div> <p>Disc is full. (No area for new recording)</p>	<p>You are trying to record onto the disc with no recording space left.</p>	<p>Insert the recordable disc with enough recording space.</p>

Troubleshooting (cont'd)

Error message	Cause	Solution
Recording Error You cannot record more than 99 titles on one disc. (The maximum is 99)	You are trying to record onto the disc on which the number of recording titles already reached the maximum (99).	Delete unnecessary titles (pages 54, 57).
Recording Error You cannot record more than 999 chapters on one disc. (The maximum is 999)	You are trying to record onto the VR mode DVD-RW disc on which the number of recording chapters already reached to the maximum (999).	This unit cannot delete the original chapter. Delete unnecessary chapter marker using other DVD recorders. Delete unnecessary titles from the Original list (page 57).
Recording Error You cannot record on this disc as Control Information is full.	This disc has no space to write the Control Information when recording or deleting contents. When editing has been repeatedly performed, the control Information area may become full even if the recording area still has enough space.	Delete unnecessary titles (pages 54, 57).
Recording Error You cannot record on this disc as Power Calibration Area is full.	When recordings are performed repeatedly onto an unstable disc, this area may become full. Every time you insert a disc for recording, the disc's working area will be taken up. And if you repeat this frequently, it will be used up sooner and you may not be able to record full 99 titles.	Insert a new disc.
Recording Error This disc is already finalized.	You are trying to record onto the disc already finalized.	Undo finalizing of the disc (page 36).

* If you are still having trouble with this unit after checking Troubleshooting, write down the error code and the error description, and call our helpline mentioned on the front page to locate an Authorized Service Center.

RF output switch

You can watch the TV programs with the tuner of the unit. (Usually channel 3 or 4 of the TV is available for the RF converter setting.) Be sure to connect the unit to a TV using the RF cable. Refer to page 14.

1
Select channel 3 on your TV.

2
Press [VIDEO/TV] on the remote control.

• If noise appears, change the RF output channel of the unit to CH 4 by pressing [VIDEO/TV] for 3 seconds. The RF output channel will alternate between CH3 and CH4 as follows.

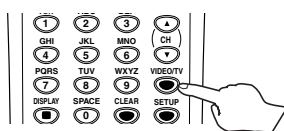

for more than 3 seconds

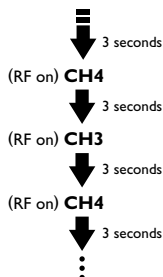

• Each time the RF output channel is changed, CH3 or CH4 will appear on the front panel display.

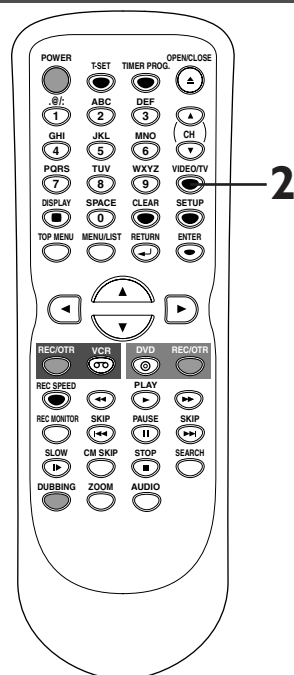

Others

Glossary

Analog audio

An electrical signal that directly represents sound. In contrast, digital audio which can be an electrical signal, but is an indirect representation of sound. See also Digital audio.

Aspect ratio

The width of a TV screen relative to its height. Conventional TVs are 4:3 (in other words, the screen is almost square); widescreen models are 16:9 (the screen is almost twice as wide as it is high).

Chapter

Just as a book is split up into several chapters, a title on a DVD disc is usually divided into chapters. See also Title.

Component video output

This is a video signal format that conveys each of three principal colors of light (red, blue and green) through different signal lines. This allows the viewers to experience picture colors as original as it is. There are several signal formats, including Y/Pb/Pr and Y/Cb/Cr.

CPRM (Content Protection for Recordable Media)

This is a format used to record copy-once programs. By recording coded data on the area of DVD discs that ordinary writing software cannot write on, it prevents copy-once programs from being recorded repeatedly on different media.

Digital audio

An indirect representation of sound by numbers. During recording, the sound is measured at discrete intervals (44, 100 times a second for CD audio) by an analog-to-digital convert-

er, generating a stream of numbers. On playback, a digital-to-analog converter generates an analog signal based on these numbers. See also Sampling frequency and Analog audio.

Dolby Digital

The system developed by Dolby Laboratories to compress digital sound. It offers you sound of stereo(2ch) or multi-channel audio (up to 5.1ch).

Finalize

To make recorded contents on DVD discs possible to be played back on DVD players. With this unit, it is possible to finalize DVD-RW/DVD-R discs.

MP3 (MPEG Audio Layer 3)

MP3 is a method of compressing files. You can copy MP3 files on CD-RW/R discs from the computer and play back the files on this unit.

PCM (Pulse Code Modulation)

PCM is a format that converts audio into digital data. It is mainly used for Audio CDs and DAT. This unit can play back sounds as realistic as possible by converting even compressed Dolby Digital and MPEG audio to PCM.

Playlist

From this list you can play back contents of a disc in your desired order or sequence. Also it allows to search a specific scene directly.

Regions code

Regions associate discs and players with particular areas of the world. This unit will only play back discs that have compatible region codes. You can find the region code of your unit by looking at the rear panel. Some discs are compatible with more than one region (or all regions).

Sampling frequency

The rate which sound is measured by a specified interval to turn it into digital audio data. The numbers of sampling in one second defines as sampling frequency. The higher the rate, the better the sound quality is.

SAP (Secondary Audio Program)

Sub-audio channel which is delivered separately from main-audio channel. This audio channel is used as an alternate in bilingual broadcasting.

S-Video output

It delivers independently each signal of color(C) and luminance(Y) to TV as video signals, so that higher-quality picture will be materialized.

Title (DVD only)

A collection of chapters on DVD disc. See also chapter.

Track

Audio CDs use tracks to divide the content of a disc. The DVD equivalent is called a chapter. See also Chapter.

Language code

Language	Code
Abkhazian	4748
Afar	4747
Afrikaans	4752
Albanian	6563
Amharic	4759
Arabic	4764
Armenian	5471
Assamese	4765
Aymara	4771
Azerbaijani	4772
Bashkir	4847
Basque	5167
Bengali; Bangla	4860
Bhutani	5072
Bihari	4854
Bislama	4855
Breton	4864
Bulgarian	4853
Burmese	5971
Byelorussian	4851
Cambodian	5759
Catalan	4947
Chinese	7254
Corsican	4961
Croatian	5464
Czech	4965
Danish	5047
Dutch	6058
English	5160
Esperanto	5161
Estonian	5166
Faroese	5261
Fiji	5256
Finnish	5255

Language	Code
French	5264
Frisian	5271
Galician	5358
Georgian	5747
German	5051
Greek	5158
Greenlandic	5758
Guarani	5360
Gujarati	5367
Hausa	5447
Hebrew	5569
Hindi	5455
Hungarian	5467
Icelandic	5565
Indonesian	5560
Interlingua	5547
Interlingue	5551
Inupiak	5557
Irish	5347
Italian	5566
Japanese	5647
Javanese	5669
Kannada	5760
Kashmiri	5765
Kazakh	5757
Kinyarwanda	6469
Kirghiz	5771
Kirundi	6460
Korean	5761
Kurdish	5767
Laothian	5861
Latin	5847
Latvian; Lettish	5868
Lingala	5860

Language	Code
Lithuanian	5866
Macedonian	5957
Malagasy	5953
Malay	5965
Malayalam	5958
Maltese	5966
Maori	5955
Marathi	5964
Moldavian	5961
Mongolian	5960
Nauru	6047
Nepali	6051
Norwegian	6061
Occitan	6149
Oriya	6164
(Afan) Oromo	6159
Panjabi	6247
Pashto; Pushto	6265
Persian	5247
Polish	6258
Portuguese	6266
Quechua	6367
Rhaeto-Romance	6459
Romanian	6461
Russian	6467
Samoan	6559
Sangho	6553
Sanskrit	6547
Scots Gaelic	5350
Serbian	6564
Serbo-Croatian	6554
Sesotho	6566
Setswana	6660
Shona	6560

Language	Code
Sindhi	6550
Singhalese	6555
Siswat	6565
Slovak	6557
Slovenian	6558
Somali	6561
Spanish	5165
Sundanese	6567
Swahili	6569
Swedish	6568
Tagalog	6658
Tajik	6653
Tamil	6647
Tatar	6666
Telugu	6651
Thai	6654
Tibetan	4861
Tigrinya	6655
Tonga	6661
Tsonga	6665
Turkish	6664
Turkmen	6657
Twí	6669
Ukrainian	6757
Urdu	6764
Uzbek	6772
Vietnamese	6855
Volapuk	6861
Welsh	4971
Wolof	6961
Xhosa	7054
Yiddish	5655
Yoruba	7161
Zulu	7267

Frequently Asked Questions

- Can I record on CD-R/RW?
No, this unit records only DVDs.
- Can I play back DVD-Video that is bought in another country?
Possible only if the region code of the disc is 1 and ALL.
- Is this unit JPEG compatible?
No.
- Can I connect the unit to my PC?
No, you cannot control the unit by PCs.

Specifications

General

System	DVD-Video, DVD-RW/R, CD-DA, CD-RW/R, Video Cassette Tape	Dimensions (width x height x depth)	17 1/8" x 3 15/16" x 10 1/4" (435 x 100 x 261 mm)
VCR video heads	Four heads	Operating temperature	41F° to 104F° (5°C to 40°C)
Power requirements	AC120V, 60 Hz	Operating humidity	less than 80% (no condensation)
Power consumption	30 W (standby: 3.0 W)	TV format	NTSC
Weight	9.5 lbs (4.3 kg)		

Recording

Recording format	Video Recording Format (DVD-RW only), Video Format (DVD-RW, DVD-R)	Video recording format	
		Sampling frequency	13.5MHz
		Compression format	MPEG
Recordable discs	DVD-ReWritable, DVD-Recordable	Audio recording format	
		Sampling frequency	48kHz
		Compression format	Dolby Digital

Tuner

Receivable channels	RF Converter
VHF	Built-in VHF converter
UHF	Converter output
CATV	VHF channel 3 or 4
2-13ch	
14-69ch	
C1-C125ch	

Input/Output

Video input	Video output
Input level	Output level
Jacks	Jacks
Input 1 (rear), 2 (front)	1 Vp-p (75Ω)
1 Vp-p (75Ω)	RCA jack
RCA jack	
S-Video input	S-Video output
Y (luminance)	Y (luminance)
- Input level	- Output level
1 Vp-p (75Ω)	1 Vp-p (75Ω)
C (color)	C (color)
- Input level	- Output level
286 mVp-p (75Ω)	286 mVp-p (75Ω)
Jacks	Jack
4 pin mini DIN	4 pin mini DIN
Audio input	Audio output
Input 1 (rear), 2 (front) L/R	Output 1,2 L/R
During audio input	During audio output
2V rms (47kΩ)	2V rms (47kΩ)
Jacks	Jacks
RCA jacks	RCA jacks
Component video output	Digital audio output
Output level	Output level
Y: 1.0Vp-p (75Ω),	Jacks
Pb/Cb, Pr/Cr: 0.7Vp-p (75Ω)	500 mVp-p (75Ω)
Jacks	RCA jack
RCA jacks	
	VHF/UHF antenna
	input/output terminal
	VHF/UHF set 75Ω

Note:

The specifications and design of this product are subject to change without notice.

Fácil grabación de DVD

Estas instrucciones le ayudarán a entender fácilmente cómo grabar discos DVD.

Nota:

Asegúrese que las pilas están en el mando a distancia y que ha conectado correctamente esta unidad y el TV.

Paso 1: Elija un tipo de disco

Puede elegir entre distintos tipos de discos DVD grabables. Elija un tipo de disco DVD grabable de acuerdo con sus necesidades de reproducción/grabación. Vea los "tipos de discos DVD" en la parte inferior de esta página para más detalles sobre las diferencias entre los distintos medios compatibles.

Este grabador de DVD puede grabar los siguientes tipos de discos.

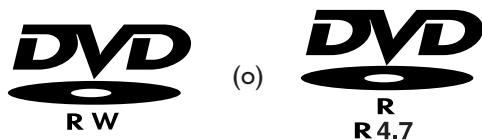

Por ejemplo, cuando desea grabar repetidamente en el mismo disco o cuando desea editar el disco después de grabar, seleccione el disco de tipo regrabable DVD-RW.

Cuando desea guardar grabaciones sin alterarlos, un DVD no regrabable DVD-R puede ser más conveniente.

Paso 2: Coloque un disco en blanco

Mando a distancia

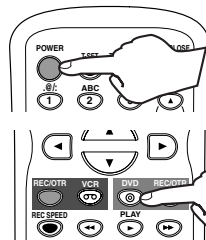

1 Para encender

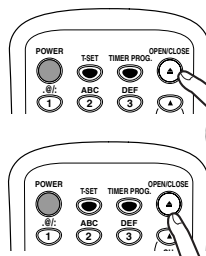

2 Seleccione el modo DVD

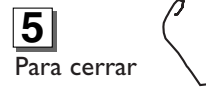

3 Para abrir

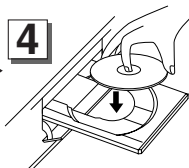

4

5 Para cerrar



Esta operación puede demorar en reconocerse.

Tipos de discos DVD

☆☆☆ : Más adecuado. ☆☆☆ : Puede utilizar. ☆ : Algunas funciones son limitadas. — : No puede utilizar.

Desea	DVD-RW VR	DVD-RW Video	DVD-R
Grabar programas de TV	☆☆☆	☆☆☆	☆☆
Volver a utilizar borrando partes no deseadas	☆☆☆	☆☆	—
Editar las grabaciones	☆☆☆	☆	☆
Editar/grabar de equipos conectados	☆☆☆	☆☆☆	☆☆☆
Copiar discos para distribución	☆☆ ^{*1}	☆☆☆	☆☆☆
Reproducir en otro equipo de DVD	☆☆ ^{*1}	☆☆☆	☆☆☆

Detalles	DVD-RW VR	DVD-RW Video	DVD-R
Grabación			
¿Regrabable?	Sí	Sí	No
Puede crear capítulos a intervalos fijos (auto.)	Sí	Sí	Sí
Puede crear capítulos donde desee (manual)	Sí	No	No
Puede grabar imágenes de tamaño 16:9	Sí	Sí	Sí
Puede grabar un programa de Copia-una-vez	Sí	No	No
Edición			
Puede hacer funciones de edición básica	Sí	Sí	Sí
Puede hacer funciones de edición avanzadas (edición de lista a reproducir)	Sí	No	No

*1 El DVD-RW (modo VR) sólo puede reproducirse en equipos de DVD compatibles con VR.

Nota:
Para más detalles sobre las funciones anteriores y las limitaciones implícitas, lea las explicaciones en este manual.

Formato del disco

Cuando coloque un disco que fue grabado, puede borrar todo el contenido formateando el disco.

El formato es necesario para preparar el disco grabado previamente para grabar.

Al formatear, todo el contenido de ese disco se borrará.

- La unidad empieza a iniciar automáticamente cuando se inserta un disco no usado.

Paso 3: Seleccione la velocidad de grabación

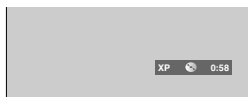
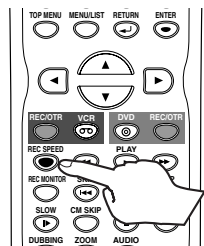

Paso 4: Seleccione el canal deseado

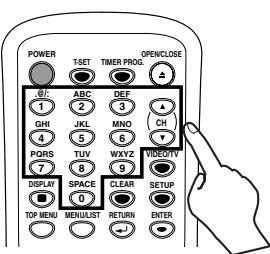

Paso 5: Grabe en discos DVD

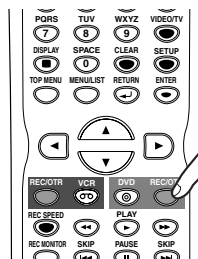

Sugerencia 1: Reproduzca el contenido grabado

Puede seleccionar el título que desea reproducir de un menú indicado y empiece a reproducir inmediatamente. El contenido grabado se puede acceder fácilmente con un simple procedimiento de elegir un título en un capítulo en la pantalla del menú.

¿Qué son títulos y capítulos?

El contenido de un disco DVD se divide generalmente en títulos. Los títulos pueden dividirse a su vez en capítulos.

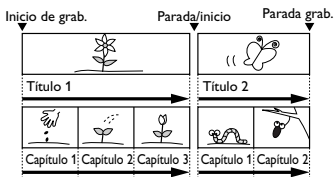

Sugerencia 2: Edite el disco grabado

La edición de discos es fácil. Esta unidad ofrece convenientes funciones de edición que sólo son posibles con discos DVD-R/RW.

Puede editar lo siguiente de la lista de títulos.

- Poniendo nombres en títulos
 - Seleccionando imágenes para índices
 - Seleccionando/borrando marcadores de capítulos
 - Borrado de títulos o escenas
- (Las funciones editables dependen del modo de grabación y forma de edición.)

Original y Playlist (modo VR)

Puede editar las grabaciones en la lista a reproducir sin cambiar las grabaciones originales. Cualquier lista a reproducir no ocupa mucho espacio en el disco.

¿Qué significa "Original" o "Playlist"?

A lo largo de este manual encontrará *Original* y *Playlist* que se refieren a las grabaciones reales y la versión editada.

- La grabación **Original** se refiere a la grabación real en el disco.
- El **Playlist** se refiere a la versión editada del disco; cómo se va a reproducir la versión Original.

Finalización de un disco

- Para reproducir el disco en un reproductor DVD diferente, grabe el disco en el modo de vídeo y finalícelo.
- Después de finalizar un disco grabado en el modo de vídeo, usted no podrá editar ninguna información que se encuentre en este disco.
- Para un disco grabado en el modo VR, la edición podrá realizarse incluso después de la finalización.

Paso 6: Pare la grabación

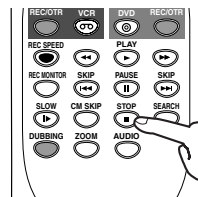

(Aparece sólo en el modo VR)

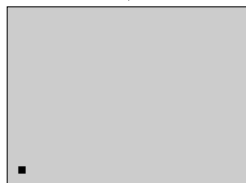

Esta operación puede demorar en completarse.

Reproducción con videgrabadora



1

Presione **[POWER]** en el mando a distancia o el panel frontal de la unidad.

Cuando reproduzca una cinta, conecte el TV y asegúrese de seleccionar la entrada donde se conecta la unidad.

Presione:



2

Coloque una cinta pregrabada y presione **[PLAY ►]** para empezar la reproducción.

3

Durante la reproducción, presione **[PAUSE II]**.

Se hará una pausa de reproducción y se silenciará el sonido.

4

Presione **[PLAY ►]** para continuar la reproducción.

5

Presione **[STOP ■]** para detener la reproducción.

6

Presione **[STOP ■ / EJECT ▲]** en el panel frontal de la unidad para expulsar la cinta.

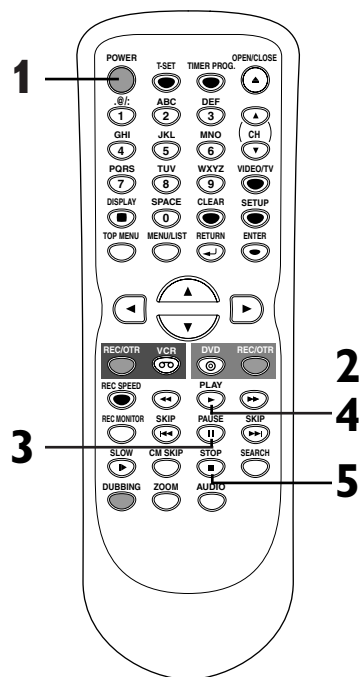

Nota

- Cuando se coloca una cinta sin la lengüeta de grabación, la unidad empezará a reproducir automáticamente.
- El seguimiento se ajustará automáticamente para la reproducción. Para ajustar manualmente el seguimiento, utilizar **[CHANNEL ▲ / ▼]** en el panel frontal de la unidad o los botones **[CH ▲ / ▼]** en el mando a distancia.

Grabación y grabación con temporizador de un toque (VCR)

Grabación



Antes de grabar, asegúrese de que:

- Seleccione el canal deseado utilizando **los botones numéricos** en el mando a distancia o **[CHANNEL ▲ / ▼]** en el panel frontal de la unidad.
- Hay una cinta con la lengüeta para grabación intacta en la unidad.
- Seleccione la velocidad de grabación deseada en SP (reproducción estándar) o SLP (reproducción de super larga duración) presionando **[REC SPEED]** en el mando a distancia.

Velocidad de grabación:

Velocidad de la cinta	Tiempo de grabación/reproducción		
	T60	T120	T160
Modo SP	1 hora	2 horas	2-2/3 horas
Modo SLP	3 horas	6 horas	8 horas

- Seleccione Estéreo o SAP.

.....
1

Presione **[REC/OTR] (VCR)** para empezar la grabación.

Para detener temporalmente la grabación o continuarla, presione **[PAUSE II]**. Después de que la unidad haya estado en el modo de pausa durante 5 minutos, se detendrá automáticamente para proteger la cinta y el cabezal de video contra cambios.

.....
2

Presione **[STOP ■]** cuando se complete la grabación.

Prevención contra borrado accidental

Para evitar una grabación por accidente en un casete grabado, rompa la lengüeta de grabación. Para volver a grabar posteriormente, cubra el orificio con cinta adhesiva.

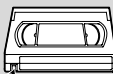

Lengüeta de grabación

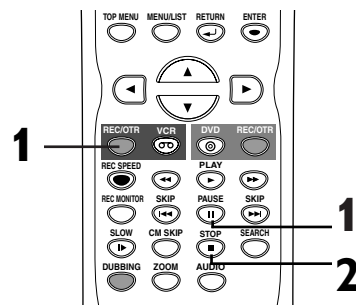

Nota

- Para ver un canal mientras graba en otro
 - 1) Mientras está grabando en la unidad, presione **[VIDEO/TV]**.
 - 2) En la caja de cable o caja de satélite, seleccione el canal que desea ver.
- Si se conectó la unidad a una caja de cable o caja de satélite, consulte la sección de "Connection to a cable box or satellite box" en la página 15.

Grabación con temporizador de un toque (OTR)



Esta función permite seleccionar la longitud de la grabación simplemente presionando **[REC/OTR] (VCR)** en el mando a distancia o **[RECORD] (VCR)** en el panel frontal de la unidad.

.....
1

Durante la grabación normal, presione **[REC/OTR] (VCR)** para empezar la grabación con temporizador de un toque.

Puede seleccionar un tiempo de grabación determinado presionando repetidamente **[REC/OTR] (VCR)**.



Cuando termina la grabación con temporizador de un toque, la unidad se desconectará automáticamente.

Para cambiar la longitud de tiempo durante la grabación con temporizador de un toque, presione repetidamente **[REC/OTR] (VCR)** hasta que aparezca la longitud deseada.

Para cancelar la grabación con temporizador de un toque dentro del tiempo especificado, presione **[STOP ■]**.

Nota

- El tiempo de grabación remanente aparecerá en la pantalla durante una grabación con temporizador de un toque. Presione **[DISPLAY]** para que aparezca en la pantalla de TV.
- **No puede hacer una pausa en una grabación con temporizador de un toque.**
- Si se termina el OTR en la videograbadora durante el modo de reproducción o REC en DVD, la videograbadora estará en el modo STOP y la DVD se mantiene en el modo actual.

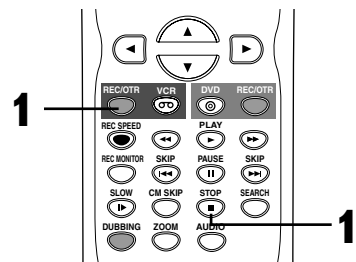

- A diferencia de una grabación con temporizador, durante una grabación con temporizador de un toque usted puede realizar las operaciones siguientes.
 - Desconectar la alimentación
 - Utilizar **[REC/OTR] (VCR)** o **[STOP ■]**.
- Cuando termina la OTR y se apaga la electricidad, la unidad cambiará automáticamente al modo de espera si se programó una grabación con temporizador. Presione **[T-SET]** para cancelar el modo de espera, para utilizar continuamente la unidad.

FUNAI CORPORATION LIMITED WARRANTY

FUNAI CORP. will repair this product, free of charge in the USA in the event of defect in materials or workmanship as follows:

DURATION:

PARTS: FUNAI CORP. will provide parts to replace defective parts without charge for one (1) year from the date of original retail purchase. Certain parts are excluded from this warranty.

LABOR: FUNAI CORP. will provide the labor without charge for a period of ninety (90) days from the date of original retail purchase.

LIMITS AND EXCLUSIONS:

This warranty is extended only to the original retail purchaser. A purchase receipt or other proof of original retail purchase will be required together with the product to obtain service under this warranty.

This warranty shall not be extended to any other person or transferee.

This warranty is void and of no effect if any serial numbers on the product are altered, replaced, defaced, missing or if service was attempted by an unauthorized service center. This FUNAI CORPORATION Limited warranty does not apply to any product not purchased and used in the United States.

This product is produced for home use and this warranty only covers failures due to defects in material or workmanship which occurs during normal use. It does not cover damage which occurs in shipment, or failures which are caused by repairs, alterations or product not supplied by FUNAI CORP., or damage which results from accident, misuse, abuse, mishandling, misapplication, alteration, faulty installation, improper maintenance, commercial use such as hotel, rental or office use of this product or damage which results from fire, flood, lightning or other acts of God.

THIS WARRANTY DOES NOT COVER PACKING MATERIALS, ANY ACCESSORIES (EXCEPT REMOTE CONTROL), ANY COSMETIC PARTS, COMPLETE ASSEMBLY PARTS, DEMO OR FLOOR MODELS.

FUNAI CORP. AND ITS REPRESENTATIVES OR AGENTS SHALL IN NO EVENT BE LIABLE FOR ANY GENERAL, INDIRECT OR CONSEQUENTIAL DAMAGES ARISING OUT OF OR OCCASIONED BY THE USE OF OR THE INABILITY TO USE THIS PRODUCT. THIS WARRANTY IS MADE IN LIEU OF ALL OTHER WARRANTIES, EX OR IMPLIED, AND OF ALL OTHER LIABILITIES ON THE PART OF FUNAI, ALL OTHER WARRANTIES INCLUDING THE WARRANTY OF MERCHANTABILITY AND FITNESS FOR A PARTICULAR PURPOSE, ARE HEREBY DISCLAIMED BY FUNAI AND ITS REPRESENTATIVES IN THE UNITED STATES. ALL WARRANTY INSPECTIONS AND REPAIRS MUST BE PERFORMED BY A FUNAI AUTHORIZED SERVICE CENTER. THIS WARRANTY IS ONLY VALID WHEN THE UNIT IS CARRIED-IN TO A FUNAI AUTHORIZED SERVICE CENTER.

IMPORTANT:

THIS LIMITED WARRANTY GIVES YOU SPECIFIC LEGAL RIGHTS. YOU MAY HAVE OTHER RIGHTS THAT VARY FROM STATE TO STATE. IF, AT ANY TIME DURING THE WARRANTY PERIOD, YOU ARE UNABLE TO OBTAIN SATISFACTION WITH THE REPAIR OF THIS PRODUCT, PLEASE CONTACT FUNAI CORP.

ATTENTION:

FUNAI CORP. RESERVES THE RIGHT TO MODIFY ANY DESIGN OF THIS PRODUCT WITHOUT PRIOR NOTICE.

To locate your nearest AUTHORIZED SERVICE CENTER or for general service inquiries, please contact us at:

**FUNAI CORPORATION
Customer Service**

**Tel : 1-800-605-8453
<http://www.Symphonic.us>**

19900 VAN NESS AVE, TORRANCE, CA 90501