

# OWNER'S MANUAL

# Symphonic

## COLOR TV/DVD SC520FDF (20 inch)

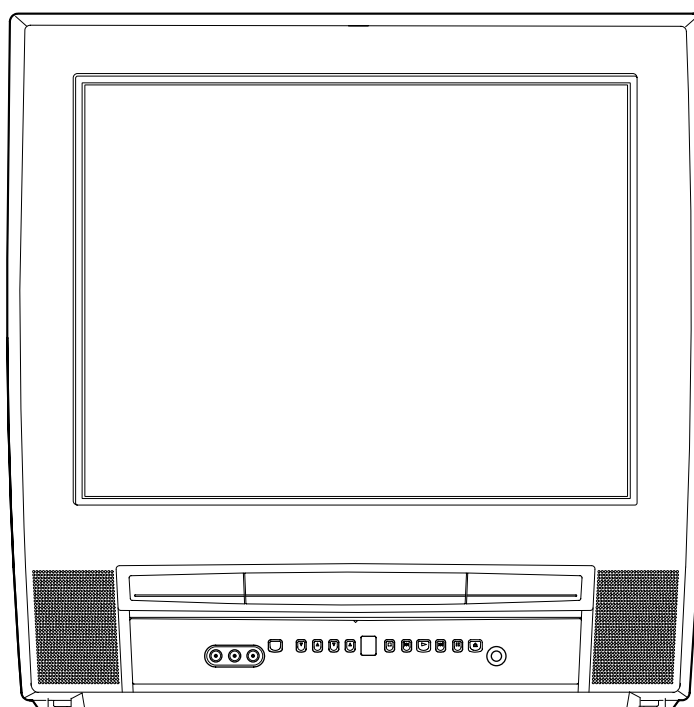

**INSTRUCCIONES EN ESPAÑOL INCLUIDAS.**

If you need additional operating assistance after reading this owner's manual or to order replacement accessories, please call  
**TOLL FREE : 1-800-242-7158.**  
Or visit our **WEB SITE** at <http://www.Symphonic.us>

Please read before using this equipment

**WARNING:** TO REDUCE THE RISK OF FIRE OR ELECTRIC SHOCK, DO NOT EXPOSE THIS APPLIANCE TO RAIN OR MOISTURE.



**CAUTION**  
**RISK OF ELECTRIC SHOCK**  
**DO NOT OPEN**



**CAUTION:** TO REDUCE THE RISK OF ELECTRIC SHOCK, DO NOT REMOVE COVER (OR BACK). NO USER SERVICEABLE PARTS INSIDE. REFER SERVICING TO QUALIFIED SERVICE PERSONNEL.



THIS SYMBOL INDICATES THAT DANGEROUS VOLTAGE CONSTITUTING A RISK OF ELECTRIC SHOCK IS PRESENT WITHIN THIS UNIT.



THIS SYMBOL INDICATES THAT THERE ARE IMPORTANT OPERATING AND MAINTENANCE INSTRUCTIONS IN THE LITERATURE ACCOMPANYING THE APPLIANCE.

The caution marking is located on the rear of the cabinet.

## IMPORTANT SAFEGUARDS

- 1. Read instructions** - All the safety and operating instructions should be read before the appliance is operated.
- 2. Retain Instructions** - The safety and operating instructions should be retained for future reference.
- 3. Heed Warnings** - All warnings on the appliance and in the operating instructions should be adhered to.
- 4. Follow Instructions** - All operating and use instructions should be followed.
- 5. Cleaning** - Unplug the unit from the wall outlet before cleaning. Do not use liquid cleaners or aerosol cleaners. Use a damp cloth for cleaning.  
**EXCEPTION:** A product that is meant for uninterrupted service and, that for some specific reason, such as the possibility of the loss of an authorization code for a CATV converter, is not intended to be unplugged by the user for cleaning or any other purpose, may exclude the reference to unplugging the appliance in the cleaning description otherwise required in item 5.
- 6. Attachments** - Do not use attachments not recommended by the unit manufacturer as they may cause hazards.
- 7. Water and Moisture** - Do not use this unit near water—for example, near a bath tub, wash bowl, kitchen sink, or laundry tub, in a wet basement, or near a swimming pool, and the like.
- 8. Accessories** - Do not place this unit on an unstable cart, stand, tripod, bracket, or table. The unit may fall, causing serious injury to someone, and serious damage to the appliance. Use only with a cart, stand, tripod, bracket, or table recommended by the manufacturer, or sold with the unit. Any mounting of the appliance should follow the manufacturer's instructions and should use a mounting accessory recommended by the manufacturer. An appliance and cart combination should be moved with care. Quick stops, excessive force, and uneven surfaces may cause the appliance and cart combination to overturn.

PORTABLE CART WARNING



S3126A

**AMEUBLES** - Cet appareil ne doit être placé que sur un meuble (avec ou sans roulettes) recommandé par le fabricant. Si vous l'installez sur un meuble à roulettes, déplacez les deux ensembles avec précaution. Un arrêt brusque, l'utilisation d'une force excessive et des surfaces irrégulières risquent de déstabiliser l'ensemble et de le renverser.

SYMBÔLE D'AVERTISSEMENT POUR  
LES COMPOSANTES  
APPAREIL ET MEUBLE À ROULETTES



S3126A

- 9. Ventilation** - Slots and openings in the cabinet and the back or bottom are provided for ventilation and to ensure reliable operation of the unit and to protect it from overheating, and these openings must not be blocked or covered. The openings should never be blocked by placing the unit on a bed, sofa, rug, or other similar surface. This unit should never be placed near or over a radiator or heat register. This unit should not be placed in a built-in installation such as a bookcase or rack unless proper ventilation is provided or the manufacturer's instructions have been adhered to.
- 10. Power Sources** - This unit should be operated only from the type of power source indicated on the marking label. If you are not sure of the type of power supply to your home, consult your appliance dealer or local power company. For the units intended to operate from battery power, or other sources, refer to the operating instructions.
- 11. Grounding or Polarization** - This unit is equipped with a polarized alternating-current line plug (a plug having one blade wider than the other). This plug will fit into the power outlet only one way. This is a safety feature. If you are unable to insert the plug fully into the outlet, try reversing the plug. If the plug should still fail to fit, contact your electrician to replace your obsolete outlet. Do not defeat the safety purpose of the polarized plug.
- 12. Power-Cord Protection** - Power-supply cords should be routed so that they are not likely to be walked on or pinched by items placed upon or against them, paying particular attention to cords at plugs, convenience receptacles, and the point where they exit from the appliance.

**FIGURE A**  
**EXAMPLE OF ANTENNA GROUNDING AS PER**  
**NATIONAL ELECTRICAL CODE**

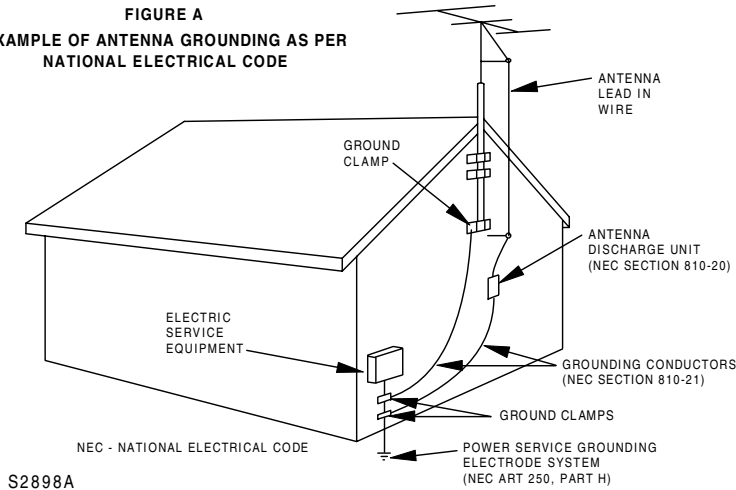

13. **Outdoor Antenna grounding** - If an outside antenna or cable system is connected to the unit, be sure the antenna or cable system is grounded so as to provide some protection against voltage surges and built-up static charges. Article 810 of the National Electrical Code, ANSI/NFPA No. 70, provides information with respect to proper grounding of the mast and supporting structure, grounding of the lead-in wire to an antenna discharge unit, size of grounding conductors, location of antenna-discharge unit, connection to grounding electrodes, and requirements for the grounding electrode. (Fig. A)
14. **Lightning** - For added protection for this unit receiver during a lightning storm, or when it is left unattended and unused for long periods of time, unplug it from the wall outlet and disconnect the antenna or cable system. This will prevent damage to the unit due to lightning and power-line surges.
15. **Power Lines** - An outside antenna system should not be located in the vicinity of overhead power lines or other electric light or power circuits, or where it can fall into such power lines or circuits. When installing an outside antenna system, extreme care should be taken to keep from touching such power lines or circuits as contact with them might be fatal.
16. **Overloading** - Do not overload wall outlets and extension cords as this can result in a risk of fire or electric shock.
17. **Object and Liquid Entry** - Never push objects of any kind into this unit through openings as they may touch dangerous voltage points or short out parts that could result in a fire or electric shock. Never spill liquid of any kind on the unit.
18. **Servicing** - Do not attempt to service this unit yourself as opening or removing covers may expose you to dangerous voltage or other hazards. Refer all servicing to qualified service personnel.
19. **Damage Requiring Service** - Unplug this unit from the wall outlet and refer servicing to qualified service personnel under the following conditions:
  - a. When the power-supply cord or plug is damaged or frayed.
  - b. If liquid has been spilled, or objects have fallen into the unit.
  - c. If the unit has been exposed to rain or water.
  - d. If the unit does not operate normally by following the operating instructions. Adjust only those controls that are covered by the operating instructions, as improper adjustment of other controls may result in damage and will often require extensive work by a qualified technician to restore the unit to its normal operation.
  - e. If the unit has been dropped or damaged in any way.
  - f. When the unit exhibits a distinct change in performance, this indicates a need for service.
20. **Replacement Parts** - When replacement parts are required, be sure the service technician has used replacement parts specified by the manufacturer that have the same characteristics as the original part. Unauthorized substitutions may result in fire, electric shock, injury to persons or other hazards.
21. **Safety Check** - Upon completion of any service or repairs to this unit, ask the service technician to perform routine safety checks to determine that the unit is in proper operating condition.
22. **Heat** - This unit product should be situated away from heat sources such as radiators, heat registers, stoves, or other products (including amplifiers) that produce heat.

# PRECAUTIONS

## IMPORTANT COPYRIGHT INFORMATION

Unauthorized copying, broadcasting, public performance and lending of discs are prohibited.

This product incorporates copyright protection technology that is protected by U.S. patents and other intellectual property rights. Use of this copyright protection technology must be authorized by Macrovision, and is intended for home and other limited viewing uses only unless otherwise authorized by Macrovision. Reverse engineering or disassembly is prohibited.

**FCC WARNING- This equipment may generate or use radio frequency energy. Changes or modifications to this equipment may cause harmful interference unless the modifications are expressly approved in the instruction manual. The user could lose the authority to operate this equipment if an unauthorized change or modification is made.**

## RADIO-TV INTERFERENCE

This equipment has been tested and found to comply with the limits for a Class B digital device, pursuant to Part 15 of the FCC Rules. These limits are designed to provide reasonable protection against harmful interference in a residential installation. This equipment generates, uses, and can radiate radio frequency energy and, if not installed and used in accordance with the instructions, may cause harmful interference to radio communications.

However, there is no guarantee that interference will not occur in a particular installation. If this equipment does cause harmful interference to radio or television reception, which can be determined by turning the equipment off and on, the user is encouraged to try to correct the interference by one or more of the following measures:

- 1) Reorient or relocate the receiving antenna.
- 2) Increase the separation between the equipment and receiver.
- 3) Connect the equipment into an outlet on a circuit different from that to which the receiver is connected.
- 4) Consult the dealer or an experienced radio/TV technician for help.

## LASER SAFETY

This unit employs a laser. Only a qualified service person should remove the cover or attempt to service this device, due to possible eye injury.

**CAUTION: USE OF CONTROLS OR ADJUSTMENTS OR PERFORMANCE OF PROCEDURES OTHER THAN THOSE SPECIFIED HEREIN MAY RESULT IN HAZARDOUS RADIATION EXPOSURE.**

**CAUTION: VISIBLE AND INVISIBLE LASER RADIATION WHEN OPEN AND INTERLOCK DEFEATED. DO NOT STARE INTO BEAM.**

**LOCATION: INSIDE, NEAR THE DECK MECHANISM.**

**This Class B digital apparatus complies with Canadian ICES-003.**

**Cet appareil numérique de la classe B est conforme à la norme NMB-003 du Canada.**

**CAUTION: TO PREVENT ELECTRIC SHOCK, MATCH WIDE BLADE OF PLUG TO WIDE SLOT, FULLY INSERT.**

**ATTENTION: POUR ÉVITER LES CHOC ÉLECTRIQUES, INTRODUIRE LA LAME LA PLUS LARGE DE LA FICHE DANS LA BORNE CORRESPONDANTE DE LA PRISE ET POUSSER JUSQU'AU FOND.**

## A NOTE ABOUT RECYCLING

Batteries should never be thrown away or incinerated but disposed of in accordance with your local regulations concerning chemical wastes.

The serial number of this product may be found on the back of the unit. No other unit has the same serial number as yours. You should record the number and other vital information here and retain this book as a permanent record of your purchase to aid identification in case of theft. Serial numbers are not kept on file.

|                      |  |
|----------------------|--|
| Date of Purchase     |  |
| Dealer Purchase from |  |
| Dealer Address       |  |
| Dealer Phone No.     |  |
| Model No.            |  |
| Serial No.           |  |

## LOCATION

For safe operation and satisfactory performance of your unit, keep the following in mind when selecting a place for its installation:

- Shield it from direct sunlight and keep it away from sources of intense heat.
- Avoid dusty or humid places.
- Avoid places with insufficient ventilation for proper heat dissipation. Do not block the ventilation holes at the top or bottom of the unit. Do not place the unit on a carpet because this will block the ventilation holes.
- Install unit in a horizontal position.
- Avoid locations subject to strong vibration.
- Do not place the unit near strong magnetic fields.
- Avoid moving the unit to locations where temperature differences are extreme.
- Be sure to remove disc and unplug the AC power cord from the outlet before carrying the unit.

## AVOID THE HAZARDS OF ELECTRICAL SHOCK AND FIRE

- Do not handle the power cord with wet hands.
- Do not pull on the power cord when disconnecting it from an AC wall outlet. Grasp it by the plug.
- If by accident, water is spilled on your unit, unplug the power cord immediately and take the unit to our Authorized Service Center for servicing.
- Do not put your fingers or objects into the unit disc loading tray.
- Do not place anything directly on top of the unit.

## WARNING

Moisture condensation may occur inside the unit when it is moved from a cold place to a warm place or after heating a cold room or under conditions of high humidity. If a DVD is played in a unit which has moisture, it may damage the DVD and the unit. Therefore when the condensation occurs inside the unit, turn the unit on and allow at least 2 hours for the unit to dry out.

## SYMBOLS USED IN THIS MANUAL

The following symbols below appear in some headings and notes in this manual, with the following meanings.

**TV**

: Description refers to TV operation (in the TV mode).

**DVD-V**

: Description refers to playback of DVD video discs (in the DVD mode).



**CD**

: Description refers to playback of Audio CDs (in the DVD mode).

**QUICK**

: Description refers to the items to be set by the QUICK mode (in the DVD mode).

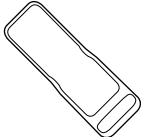
## SUPPLIED ACCESSORIES

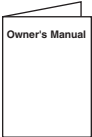
|   |  |  |
|---|--|--|
| <p>Remote Control Unit</p>  <p>( NE207UD )</p> | <p>Batteries</p>  <p>2 AA Batteries</p> | <p>Owner's Manual</p>  <p>( 1EMN20326 )</p> |
|---|--|--|

- If you need to replace these accessories, please refer to the PART NO. under the illustrations and call our help line mentioned on the front page.
- Depending on your antenna system, you may need different types of Combiners (Mixer) or Separators (Splitter). Contact your local electronics store for these items.

# TABLE OF CONTENTS

|  |    |  |    |  |            |
|--|----|--|----|--|------------|
| ■ <b>IMPORTANT SAFEGUARDS</b> . . . . .  | 2  | <b>DVD SECTION</b>                           |    | ■ <b>CHANGING THE DVD SET UP ITEMS</b> . . . . . | 26         |
| ■ <b>PRECAUTIONS</b> . . . . .   | 4  | ■ <b>ABOUT THE DISCS</b> . . . . .           | 19 | CUSTOM MENU . . . . .                            | 26         |
| LOCATION . . . . .   | 5  | PLAYABLE DISCS . . . . .                     | 19 | LANGUAGE SETTING . . . . .                       | 26         |
| AVOID THE HAZARDS OF ELECTRICAL SHOCK AND FIRE . . . . .                               | 5  | UNPLAYABLE DISCS . . . . .                   | 19 | DISPLAY SETTING . . . . .                        | 27         |
| WARNING . . . . .  | 5  | ■ <b>PLAYING A DISC</b> . . . . .            | 20 | AUDIO SETTING . . . . .                          | 27         |
| SYMBOLS USED IN THIS MANUAL . . . . .  | 5  | BASIC PLAYBACK . . . . .                     | 20 | PARENTAL CONTROL . . . . .                       | 28         |
| ■ <b>SUPPLIED ACCESSORIES</b> . . . . .  | 5  | GENERAL FEATURES . . . . .                   | 20 | OTHER SETTINGS . . . . .                         | 28         |
| ■ <b>TABLE OF CONTENTS</b> . . . . .   | 6  | DISC MENU . . . . .                          | 20 | INITIALIZE . . . . .                             | 28         |
| ■ <b>FEATURES</b> . . . . .  | 7  | TITLE MENU . . . . .                         | 20 | ■ <b>TROUBLESHOOTING GUIDE</b> . . . . .         | 29         |
| ■ <b>OPERATING CONTROLS AND FUNCTIONS</b> . . . . .                                    | 8  | RESUME . . . . .                             | 21 | ■ <b>MAINTENANCE</b> . . . . .                   | 32         |
| ■ <b>PREPARATION FOR USE</b> . . . . .   | 10 | PAUSE . . . . .                              | 21 | DISC HANDLING . . . . .                          | 32         |
| ANTENNA/CABLE CONNECTION . . . . .   | 10 | STEP BY STEP PLAYBACK . . . . .              | 21 | ■ <b>SPECIFICATIONS</b> . . . . .                | 33         |
| CONNECTING TO FRONT A/V INPUT JACKS . . . . .  | 11 | FAST FORWARD / FAST REVERSE . . . . .        | 21 | ■ <b>ESPAÑOL</b> . . . . .                       | 34         |
| CONNECTING TO A STEREO AMPLIFIER EQUIPPED WITH DIGITAL INPUT JACKS (for DVD) . . . . . | 11 | SLOW FORWARD / SLOW REVERSE . . . . .        | 21 | ■ <b>WARRANTY</b> . . . . .                      | Back Cover |
| CONNECTING TO A DOLBY DIGITAL DECODER (for DVD) . . . . .                              | 12 | ZOOM . . . . .                               | 21 |  |            |
| INSTALLING THE BATTERIES . . . . .   | 12 | ■ <b>SEARCH FUNCTION</b> . . . . .           | 22 |  |            |
|  |    | TRACK SEARCH . . . . .                       | 22 |  |            |
|  |    | TITLE / CHAPTER SEARCH . . . . .             | 22 |  |            |
|  |    | TIME SEARCH . . . . .                        | 22 |  |            |
|  |    | MARKER SETUP SCREEN . . . . .                | 22 |  |            |
|  |    | ■ <b>SPECIAL PLAYBACK FUNCTION</b> . . . . . | 23 |  |            |
|  |    | REPEAT . . . . .                             | 23 |  |            |
|  |    | PROGRAM . . . . .                            | 23 |  |            |
|  |    | RANDOM PLAYBACK . . . . .                    | 23 |  |            |
|  |    | ■ <b>CHANGING THE SETTINGS</b> . . . . .     | 24 |  |            |
|  |    | SUBTITLE LANGUAGE . . . . .                  | 24 |  |            |
|  |    | AUDIO LANGUAGE . . . . .                     | 24 |  |            |
|  |    | STEREO SOUND MODE . . . . .                  | 24 |  |            |
|  |    | CAMERA ANGLE . . . . .                       | 24 |  |            |
|  |    | BLACK LEVEL SETTING . . . . .                | 24 |  |            |
|  |    | VIRTUAL SURROUND . . . . .                   | 25 |  |            |
|  |    | ■ <b>THE ON-SCREEN INFORMATION</b> . . . . . | 25 |  |            |
| <b>TV SECTION</b>  |    |  |    |  |            |
| ■ <b>TV OPERATION AND SETTINGS</b> . . . . .   | 13 |  |    |  |            |
| WATCHING A TV PROGRAM . . . . .  | 13 |  |    |  |            |
| DEGAUSSING . . . . .   | 13 |  |    |  |            |
| PICTURE CONTROL . . . . .  | 13 |  |    |  |            |
| SLEEP TIMER . . . . .  | 14 |  |    |  |            |
| CLOSED CAPTION SYSTEM . . . . .  | 14 |  |    |  |            |
| CHANNEL SET UP . . . . .   | 15 |  |    |  |            |
| V-CHIP SET UP . . . . .  | 16 |  |    |  |            |
| TV RATING SET UP . . . . .   | 16 |  |    |  |            |
| MPAA RATING SET UP . . . . .   | 17 |  |    |  |            |
| CHANGE ACCESS CODE . . . . .   | 17 |  |    |  |            |
| MENU LANGUAGE . . . . .  | 17 |  |    |  |            |
| ■ <b>CABLE CHANNEL DESIGNATIONS</b> . . . . .  | 18 |  |    |  |            |

# FEATURES

## TV Mode

- **Infrared remote control**
- **Trilingual on screen TV setup display selectable in English, Spanish or French**
- **181 channel capability PLL frequency synthesizer tuner with direct station call** (A converter may be necessary to view scrambled cable channels.)
- **Closed Caption Decoder** – You may view specially labeled (cc) TV programs, movies, news, etc. with either a dialogue caption or text display added to the program.
- **Auto power off system** – If there is no air signal input from the antenna terminal and no operation for 15 minutes, the unit will turn itself off automatically.
- **Sleep timer** – Allows you to have the unit automatically turn off at a desired time.
- **V-CHIP** – Enables parents to prevent their children from watching inappropriate material on TV.

## DVD Mode

- **Dolby Digital sound**  
This unit can handle Dolby Digital surround sound having 5.1 channels when connected to a Dolby Digital decoder.
- **Still/fast/slow/step playback**  
Various playback modes are available including still pictures, fast forward/reverse, slow motion and step frames.
- **Random playback for Audio CD**  
This unit can shuffle the order of tracks to play them in random order.
- **Program playback for Audio CD**  
You can program the order of tracks to play them in any desired order.
- **DVD menus in a desired language**  
You can display DVD menus in a desired language, if available on a DVD.
- **Screen saver/Auto power-off functions**  
The screen saver program starts when there is no input from the unit for 5 minutes in the stop mode. After the screen saver program is activated for 15 minutes, the power automatically turns off.
- **Subtitles in a desired language**  
You can select a desired language for the display subtitles, if that language is available on a disc.
- **Selecting a camera angle**  
You can select the desired camera angle, if a disc contains sequences recorded from different angles.
- **Choices for audio language and sound mode**  
You can select the desired audio language and sound mode, if different languages and modes are available on a disc.
- **Parental lock**  
You can set the control level to limit playback of discs which may not be suitable for children.
- **Automatic detection of discs**  
This unit automatically detects if the loaded disc is DVD or Audio CD.
- **On-screen display**  
Information about the current operation can be displayed on a TV screen, allowing you to confirm the currently active functions (such as program playback), on the TV screen using the remote control.
- **Search**  
Chapter search / Title search / Track search / Time search
- **Repeat**  
Chapter / Title / Track / All / A-B
- **Zoom**  
Magnified screen can be displayed.
- **Marker**  
The part designated by user can be called back.
- **Resume Play**  
User can resume to playback from the part at which the play was stopped.
- **Virtual Surround**
- **Bit rate indication**
- **DRC (Dynamic range control)**  
You can control the range of sound volume.

# OPERATING CONTROLS AND FUNCTIONS

## - FRONT PANEL - [Fig.1]

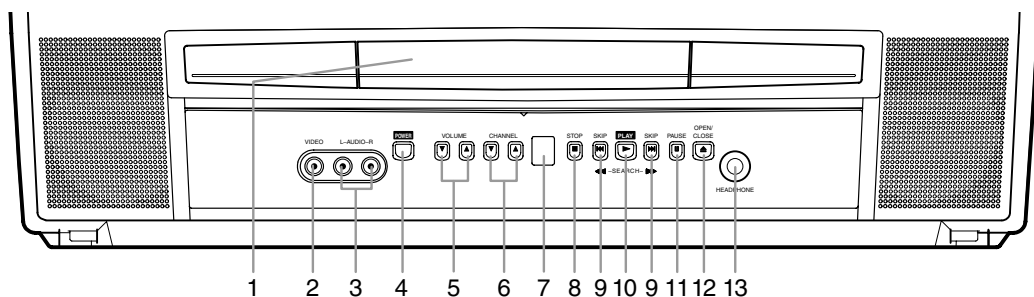

## - REMOTE CONTROL - [Fig. 2]

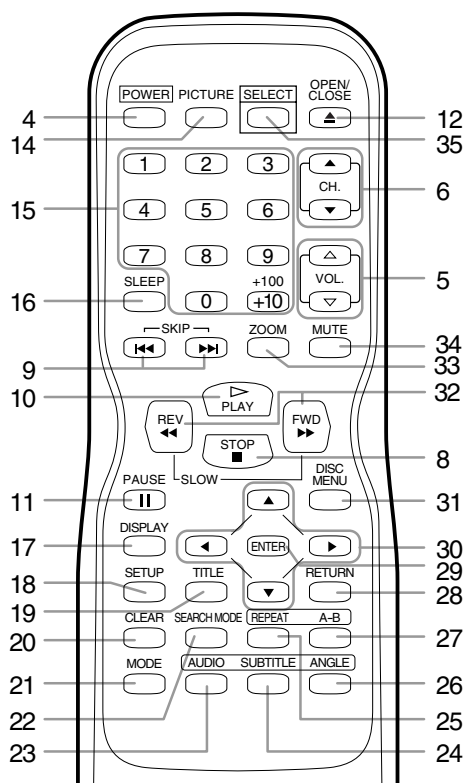

### 1. Disc loading tray

### 2. VIDEO input Jack

Connect to the video output jack of a video camera or VCR.

### 3. AUDIO L/R input Jacks

Connect to the audio output jacks of a video camera or VCR.

### 4. POWER Button [P.13]

Hit to turn the power on and off.

### 5. VOLUME (VOL.) ▲/▼ Buttons [P.13]

Press to control the volume level for the DVD and TV.

### 6. CHANNEL (CH.) ▲/▼ Buttons [P.13]

Press to select memorized channels.

### 7. Remote sensor window

### 8. STOP ■ Button [P.20]

Stops operation of the disc.

### 9. SKIP ◀◀ / ▶▶ Buttons [P.22]

Press once to skip chapters or tracks to a desired point.

### SEARCH ◀◀ / ▶▶ Buttons (Front panel) [P.21]

Press and hold to change forward or reverse playback speed.

### 10. PLAY ► Button [P.20]

Starts playback of the disc.

### 11. PAUSE || Button [P.21]

Pauses the current disc operation.

### 12. OPEN/CLOSE ▲ Button [P.20]

Hit to insert a disc into or remove it from the tray.

### 13. HEADPHONE Jack

To connect headphone (not supplied) for personal listening.

### 14. PICTURE Button [P.13]

Hit to adjust the picture.

### 15. Number Buttons

#### TV Mode: [P.13]

Press two digits to directly access the desired channel.

Remember to hit [0] before a single digit channel.

#### +100 Button-

Hit to select cable channels which are higher than 99.

#### DVD Mode: [P.22]

Hit to enter the desired number.

#### +10 Button-

Hit to enter the desired numbers which are higher than 9.

### 16. SLEEP Button [P.14]

Sets the Sleep Timer.

### 17. DISPLAY Button

#### TV Mode:

Displays the current channel number on the TV screen.

#### DVD Mode: [P.25]

Displays the current status on the TV screen.



## - REAR PANEL - [Fig.3]

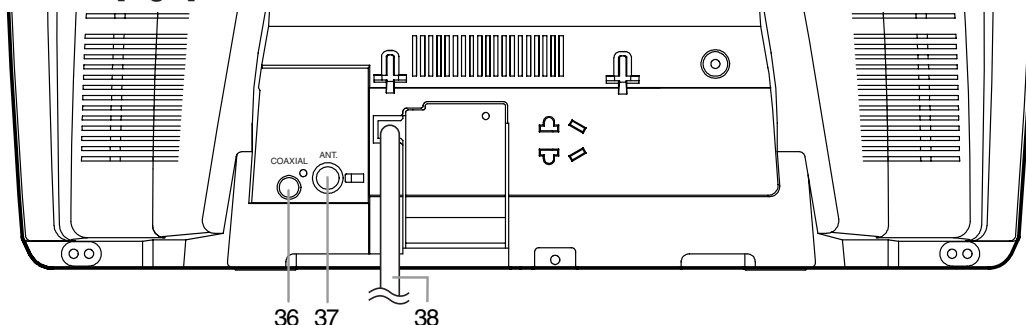

### 18. SETUP Button [P.26]

Hit to enter or exit the setup menu of TV or DVD.

### 19. TITLE Button [P.20]

Displays the title menu.

### 20. CLEAR Button [P.22]

Hit to clear or cancel a setting currently entered.

### 21. MODE Button [P.23, 24, 25]

Hit to call up the program screen or the random screen in the stop mode.

Hit to call up the Black Level Setting screen or the Virtual Surround screen during playback.

### 22. SEARCH MODE Button [P.22]

Hit to locate a desired point.

### 23. AUDIO Button [P.24]

Hit to select a desired audio language or sound mode.

### 24. SUBTITLE Button [P.24]

Hit to select a desired subtitle language.

### 25. REPEAT Button [P.23]

Repeats playback of the current disc, title, chapter, or track.

### 26. ANGLE Button [P.24]

Hit to change the camera angle to see the sequence being played back from a different angle (if available).

### 27. A-B Button [P.23]

Repeats playback of a selected section.

### 28. RETURN Button [P.22]

Returns to the previous screen in the setup menu.

### 29. ENTER Button [P.15]

Hit to accept a setting.

### 30. ▲/▼/◀/▶ Buttons

**TV Mode:** [P.13]

Press to select a setting mode from the menu on the TV screen.

Press to select or adjust from a particular menu.

**DVD Mode:** [P.20]

Press to select a menu item.

### 31. DISC MENU Button [P.20]

Calls up the DVD menu.

### 32. REV ◀◀ Button [P.21]

Hit to view the DVD picture in fast reverse or slow reverse motion.

### FWD ▶▶ Button [P.21]

Hit to view in fast or slow forward motion.

### 33. ZOOM Button [P.21]

Enlarges part of a DVD-reproduced image.

### 34. MUTE Button [P.13]

Mutes the sound. Hit it again to restore sound.

### 35. SELECT Button [P.11]

Hit to change to TV mode, external input mode or DVD mode.

### 36. COAXIAL Jack [P.11]

Connect to the digital input of an external amplifier or decoder (for DVD Audio only).

### 37. ANT(ENNA). Jack [P.10]

Connect to an antenna, cable system or satellite system.

### 38. Power cord [P.13]

Connect to a standard AC outlet (120V/60Hz).

#### NOTE:

- Remove the power cord from the hook to avoid breaking a wire before you connect to a standard AC outlet.

#### NOTE:

- We do not recommend the use of universal remote controls. Not all of the functions may be controlled with a universal remote control.

If you decide to use a universal remote control with this unit, please be aware that the code number given may not operate this unit. In this case, please call the manufacturer of the universal remote control.

# PREPARATION FOR USE

## ANTENNA/CABLE CONNECTIONS

Plug the incoming cable into the ANT. jack on the rear of the unit.  
If your cable service supplies you with a converter box or if you use a satellite system, connect the box with this unit as shown below.

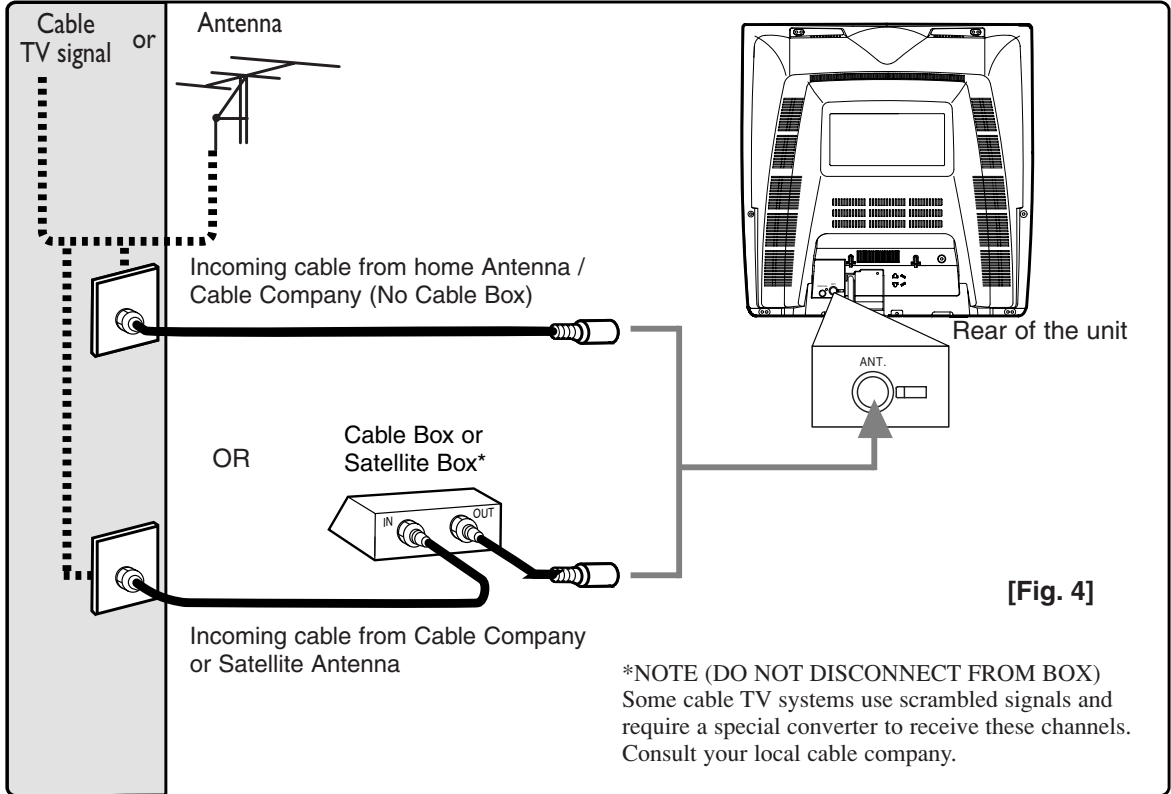

### Note to CATV system installer:

This reminder is provided to call the CATV system installer's attention to Article 820-40 of the NEC that provides guidelines for proper grounding and in particular, specifies that the cable ground shall be connected to the grounding system of the building as close to the point of cable entry as practical.

### NOTE:

Before plugging the antenna into the ANT. jack of the unit, check that the pin is not bent. If it is bent, straighten the pin as illustrated, then plug the pin into the ANT. jack of the unit.

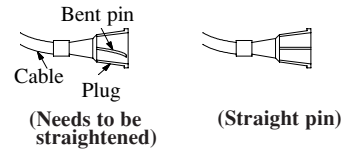

**For your safety and to avoid damages to the unit, unplug the antenna cable from the ANT. jack before moving the unit.**

## CONNECTING TO FRONT A/V INPUT JACKS

When you watch a program recorded on another source (VCR or video camera), use the AUDIO/VIDEO input jacks on the front of the unit.

Connect the Audio/Video output jacks of another source to the AUDIO L/R and VIDEO jacks of this unit.

Then press [SELECT] or [CH. ▲/▼] until “AUX” appears on the screen.

AUX

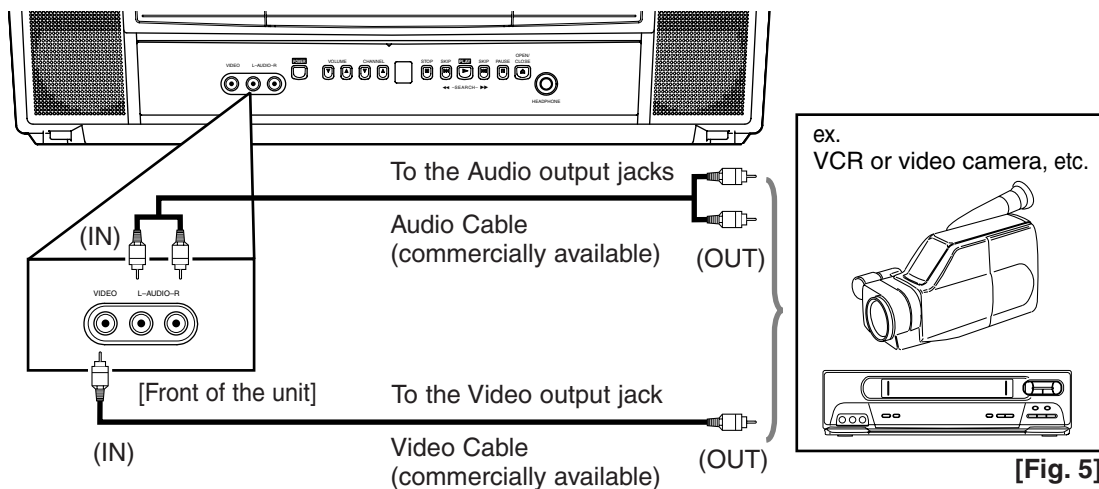

### NOTE:

- When you connect a monaural VCR (another source) to this unit, connect the Audio output jack of the monaural VCR (another source) to the AUDIO L jack of this unit. The audio will output in both L and R channel equally.

## CONNECTING TO A STEREO AMPLIFIER EQUIPPED WITH DIGITAL INPUT JACKS (for DVD)

Use an audio coaxial digital cable (commercially available) for the audio connections.

Connect to an amplifier equipped with digital input jacks such as MD Deck or DAT Deck.

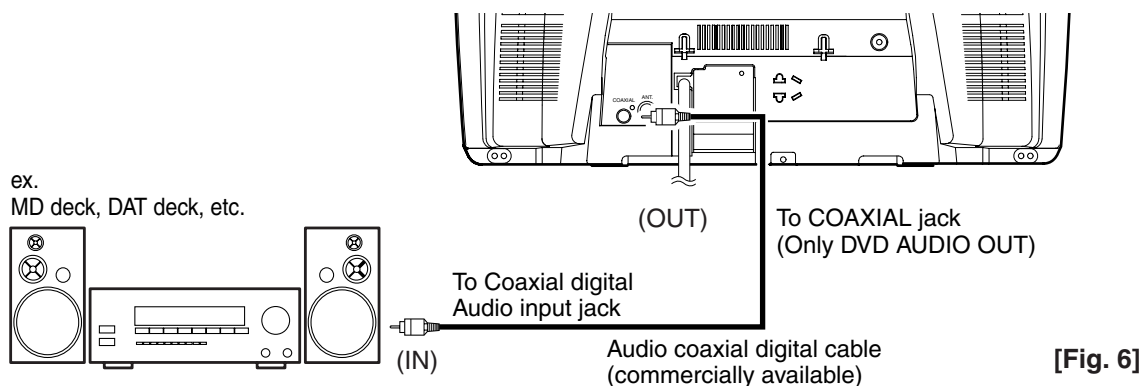

### NOTES:

- The audio source on a disc in a 5.1 channel Dolby Digital surround format cannot be recorded as digital sound by an MD or DAT deck.
- Be sure to turn off the power to all components in the system before connecting another component.
- Refer to the Owner's Manuals for the components to be connected to the unit.
- Set “DOLBY DIGITAL” to “PCM” for audio output in the setup mode. Playing a unit using incorrect settings may generate noise distortion and may also damage the speakers. (Refer to page 27.)

## CONNECTING TO A DOLBY DIGITAL DECODER (for DVD)

If using this unit to play a DVD disc in a 5.1 channel Dolby Digital surround format, the unit outputs a DOLBY DIGITAL Data stream from its COAXIAL jack. By hooking the unit up to a Dolby Digital decoder, you can enjoy a more convincing, realistic ambience with powerful and high-quality surround sound as enjoyed in movie theaters.

Use audio coaxial digital cables (commercially available) for the audio connections.

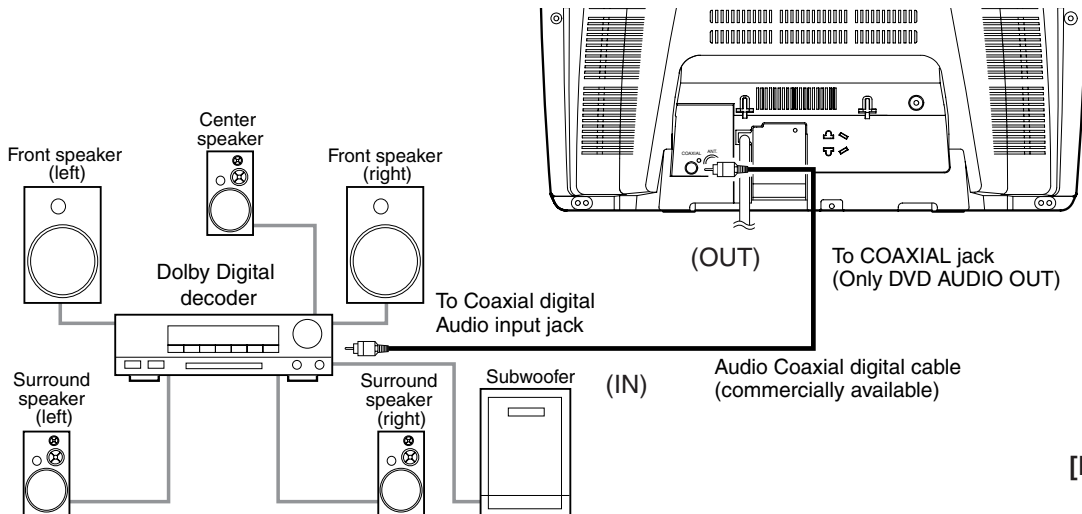

[Fig. 7]

### NOTES:

- Be sure to turn off the power to all components in the system before connecting another component.
- Refer to the Owner's Manuals for the components to be connected to the unit.
- If connected to a Dolby Digital decoder, set "DOLBY DIGITAL" to "BITSTREAM" for audio output in the setup mode. (Refer to page 27.)
- Unless connected to a Dolby Digital decoder, set "DOLBY DIGITAL" to "PCM" for audio output in the setup mode. Playing a unit using incorrect settings may generate noise distortion and may also damage the speakers. (Refer to page 27.)

Manufactured under license from Dolby Laboratories. "Dolby" and the double-D symbol are trademarks of Dolby Laboratories.

## INSTALLING THE BATTERIES

- 1) Open the battery compartment cover by pressing the cover on the remote unit in the direction of the arrow.
- 2) Insert 2 "AA" penlight batteries into the battery compartment in the direction indicated by the polarity (+/-) markings.
- 3) Replace the cover.

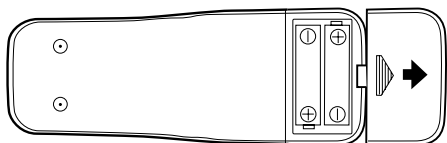

### [BATTERY PRECAUTIONS]

- Be sure to follow the correct polarity as indicated in the battery compartment. Reversed batteries may cause damage to the device.
- Do not mix different types of batteries together (e.g. Alkaline and Carbon-Zinc) or old batteries with fresh ones.
- If the device is not to be used for a long period of time, remove the batteries to prevent damage or injury from possible battery leakage.
- Do not try to recharge batteries not intended to be recharged; they can overheat and rupture.

## TV OPERATION AND SETTINGS

### WATCHING A TV PROGRAM

TV

#### 1 Plug in the unit power cord

Plug the unit power cord into a standard AC outlet.

#### NOTE:

- If any digits appear in the corner of the screen, hit [POWER] without unplugging the power cord.

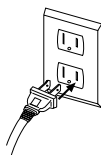

#### 2 Turn on the unit

Hit [POWER] to turn on the unit.

#### 3 Select the channel number

Press [CH. ▲/▼] or the **Number buttons** to select your desired channel number.

#### Notes for using the Number buttons:

- You must precede single-digit channel numbers with a zero (for example: 02, 03, 04 and so on).
- When selecting cable channels which are higher than 99, hit [+100] first, then press the last two digits. (Example: to select channel 125, first hit [+100] then hit [2] and [5].)

#### 4 Adjust sound

Press [VOL. ▲/▼] to adjust the volume.

Hit [MUTE] to instantly mute the sound.

Hit it again to restore the previous sound level.

#### NOTE:

- If you press [CH. ▲/▼] in the DVD mode, you can change the TV channels. Even if you turn off the unit in the DVD mode, when you turn it on again, it will go into the TV mode.

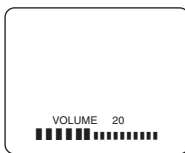

### TO WATCH CABLE OR SATELLITE CHANNEL

- If the unit is connected to a cable box or satellite box, press [CH. ▲/▼] to select CH3 or CH4 according to the output channel setting of the device and select desired channel on that device.

### TO WATCH EXTERNAL INPUT

- When an external equipment is connected to the front AUDIO/VIDEO input jacks, press [SELECT] or [CH. ▲/▼] repeatedly until "AUX" appears on the screen.

### DEGAUSSING

TV

This television has a degaussing circuit that will clear up color errors on the TV screen that are caused by any excess magnetism which happens to get too close to the TV. This circuit is designed to operate once when the set is first plugged in. **If minor color errors are seen in some locations on the screen, please unplug the TV for approximately 30 minutes.** When the TV is plugged back in, the degaussing circuit will operate once to clear them up. Repeat this procedure any time the TV screen is accidentally magnetized or when the TV is moved or relocated.

### PICTURE CONTROL

TV

The unit's picture controls – **BRIGHT, CONTRAST, COLOR, TINT** and **SHARPNESS** – are preset to factory specifications. Although they are usually the best, you may need to make some further adjustments for a more natural looking image.

#### Make sure ...

- The unit must be turned on.

#### 1 Call up the menu

Hit [PICTURE].

#### 2 Select item you want to adjust

Press [▲/▼] until desired control is displayed.

BRIGHT  
CONTRAST  
COLOR  
TINT  
SHARPNESS



#### 3 Adjust the setting

Press [◀/▶] to adjust to your desired level within 5 seconds.

|                  | ◀                      | ▶                      |
|------------------|------------------------|------------------------|
| <b>BRIGHT</b>    | to decrease brightness | to increase brightness |
| <b>CONTRAST</b>  | to decrease contrast   | to increase contrast   |
| <b>COLOR</b>     | to pale                | to brilliant           |
| <b>TINT</b>      | to purple              | to green               |
| <b>SHARPNESS</b> | to soft                | to clear               |

- Even if there is a power failure of any kind, the unit will retain its memory for this feature.

## SLEEP TIMER

TV

The Sleep Timer function turns off the unit without using [POWER] after a desired period of time.

### 1 Call up the Sleep Timer Setting

Hit [SLEEP] so that "SLEEP 0 MINUTE" appears.

### 2 Set sleep time

Hit [SLEEP] repeatedly until your desired sleep time appears.

Each additional press will increase the time by 30 minutes up to 120 minutes.

After 5 seconds, the Sleep Timer setting will disappear automatically.

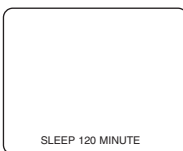

## TO CANCEL THE SLEEP TIMER

Hit [SLEEP] to call up the Sleep Timer Setting. Hit [SLEEP] repeatedly until "SLEEP 0 MINUTE" appears.

## CLOSED CAPTION SYSTEM

TV

You can view specially labeled (cc) TV programs, movies, news and pre-recorded tapes with either a dialogue caption or text display.

**CAPTION mode:** You can watch dramas, movies and news while captioning the dialogues and the contents of news.

**TEXT mode:** You can watch half screen text information if you want.

**1-2:** You may get these captions or text information by selecting either "1" or "2". Caption "2" is usually used for a second language if available.

### NOTES:

- Not all programs are broadcast with closed captions. Your unit is designed to provide error free closed captions from high quality antenna, cable and VCR signals. Conversely, poor quality signals are likely to result in caption errors or no captions at all. Common signal conditions which may cause caption errors are listed below:
  - Automobile ignition noise
  - Electric motor brush noise
  - Weak snowy reception on TV screen
  - Multiplex signal reception displaying picture ghosts or airplane flutter

- If the unit displays a black box on the TV screen, this means that the unit is set to the TEXT mode. To clear screen, select [CAPTION1], [CAPTION2] or [OFF].



### Make sure ...

- The unit must be turned on.

### 1 Select "CAPTION"

Hit [SETUP].

Press [▲/▼] to point to "CAPTION".

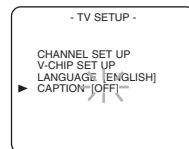

### 2 Select your desired caption mode

Hit [ENTER] repeatedly until your desired caption menu appears.

([CAPTION1], [CAPTION2], [TEXT1] or [TEXT2])

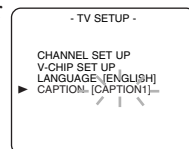

### 3 Exit the caption setting mode

Hit [SETUP] to exit the menu.

### NOTE:

- Even if there is a power failure of any kind, the unit will retain its memory for this feature.

## TO CANCEL THE CLOSED CAPTION SYSTEM

Repeat steps 1 to 2 and select [OFF] using [ENTER]. Then hit [SETUP] to return to TV mode.

## CHANNEL SET UP

### Make sure ...

- The unit must be turned on.

TV

## AUTO CHANNEL PROGRAMMING

As the initial setting, this unit has memorized all channels, including the ones not available in your area. This feature automatically puts only available channels into the memory.

### 1 Select "CHANNEL SET UP"

Hit [SETUP].

Press [▲/▼] to point to "CHANNEL SET UP", then hit [ENTER].

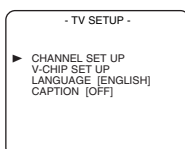

### 2 Begin channel scanning

Press [▲/▼] to point to "AUTO CH PROGRAMMING", then hit [ENTER].

The tuner scans and memorizes all the active channels in your area.

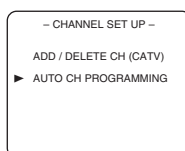

### 3 After scanning

The tuner stops on the lowest memorized channel.

#### NOTES:

- When "AUTO CH PROGRAMMING" is activated where there is no TV signal input, "NO TV SIGNALS" will appear on the display after the completion of channel scanning.
- The unit may recognize CATV channels to be TV channels if reception condition is poor. In this case, check the antenna connection and try "AUTO CH PROGRAMMING" again when reception conditions are better.
- **Channel memory programming is NOT necessary when connected to a cable box or satellite box. Just select the channel for cable box or satellite input (ex. CH3) on the unit, then select your desired channel on the cable box or satellite box.**

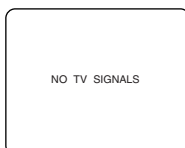

## ADDING/DELETING CHANNELS

The channels you no longer receive or seldom watch can be deleted from the memory. (Of course, you can add the deleted channel into the memory again.)

### 1 Select "CHANNEL SET UP"

Hit [SETUP].

Press [▲/▼] to point to "CHANNEL SET UP", then hit [ENTER].

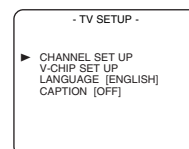

### 2 Select "ADD/DELETE CH"

Press [▲/▼] to point to "ADD/DELETE CH", then hit [ENTER].

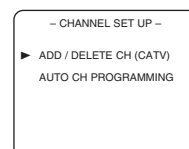

### 3 Enter the desired channel number

Press [CH. ▲/▼] or the **Number buttons** until your desired channel number appears. (You can also press [▲/▼] to enter it.)

- You must precede single-digit channel numbers with a zero (Example: 02 ... 09). (Example: CH8)
- When selecting cable channels which are higher than 99, hit [+100] first, then press the last two digits. (Example: to select channel 125, first hit [+100] then hit [2] and [5].)

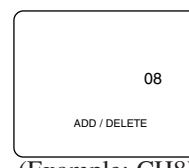

### 4 Delete (or add) it from (or into) memory

Hit [ENTER]. The channel number changes to light red. The channel is deleted from memory.

- To delete another channel, repeat steps **3** to **4**.
- If you hit [ENTER] again, the channel is memorized again.

**Added channel : Light blue**  
**Deleted channel : Light red**

### 5 Exit the channel setup mode

Hit [SETUP] to exit the menu.

#### NOTE:

- To confirm that channel(s) has been deleted or added, press [CH. ▲/▼].

# V-CHIP SET UP

TV

This feature enables parents to prevent their children from watching inappropriate material on TV. When you try to access a program which is blocked, "PROTECTED PROGRAM by ..." message appears on the TV screen.

## V-CHIP SET UP

**Make sure ...**

- The unit must be turned on.

### 1 Select "V-CHIP SET UP"

Hit [SETUP].

Press [▲/▼] to select "V-CHIP SET UP", then hit [ENTER].

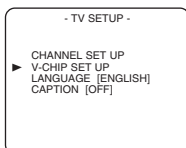

### 2 Enter Access code

Press the **Number** buttons to enter the access code.

- For the first time set-up or in the event the unit has lost power, enter the default code of 0000.

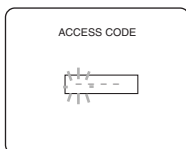

### 3 Select the desired item

Press [▲/▼] to select "TV RATING", "MPAA RATING" or "CHANGE CODE", then hit [ENTER].

Refer to the pages below to set up each item.

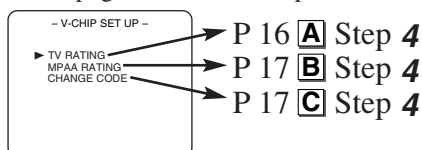

## A TV RATING SET UP

Follow steps 1 to 3 in the "V-CHIP SET UP" section above.

### 4 Blocking TV programs

Press [▲/▼] to select a rating that you wish to block.

Hit [ENTER] repeatedly to set it to [BLOCK] or [VIEW].

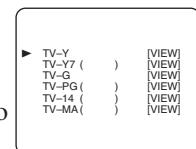

| Selection | Rating Category Explanations             |
|-----------|--|
| TV-Y      | Appropriate for all children             |
| TV-Y7     | Appropriate for children seven and older |
| TV-G      | General Audience                         |
| TV-PG     | Parental Guidance suggested              |
| TV-14     | Unsuitable for children under 14         |
| TV-MA     | Mature audience only                     |

## NOTES:

- When you select a rating and set it to [BLOCK], the higher ratings will be blocked automatically. The lower ratings will be available for viewing.
- When you set the lowest rating to [VIEW], all other ratings will automatically be available for viewing.

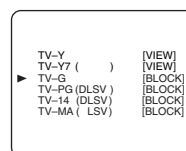

## 5 Setting "Sub-Ratings"

When you select the ratings of TV-Y7, TV-PG, TV-14 or TV-MA you will have the option of setting sub rating categories.

Press [▲/▼] to select a rating with sub-ratings you wish to block, then hit [ENTER] twice.

Press [▲/▼] to select a sub-rating, then hit [ENTER] to set it to [BLOCK] or [VIEW].

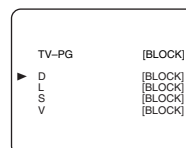
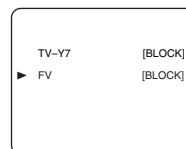
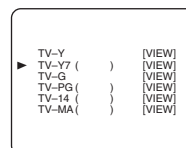

| Selection                  | Rating Category Explanations          |
|----------------------------|---------------------------------------|
| <b>TV-Y7</b>               |                                       |
| FV                         | Fantasy Violence                      |
| <b>TV-PG, TV-14, TV-MA</b> |                                       |
| D                          | Suggestive Dialog (TV-PG, TV-14 only) |
| L                          | Coarse Language                       |
| S                          | Sexual Situation                      |
| V                          | Violence                              |

## NOTE:

- The blocked sub-ratings will appear next to the rating category in the "TV RATING" menu.

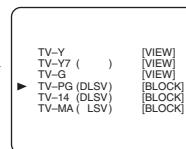

## 6 Exit the V-Chip setting mode

Hit [SETUP] to exit the menu.

## NOTE:

- To change the rating, the TV must be turned to an unprotected program. If "PROTECTED PROGRAM by ..." appears on the screen, please change the channel to a station that is not protected.

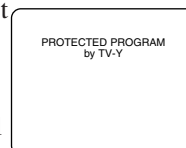



## **B** MPA A RATING SET UP

Follow steps **1** to **3** in the “V-CHIP SET UP” section on page 16.

### **4** Select your desired item

Press **[▲/▼]** to point to your desired item, then hit **[ENTER]** to select **[BLOCK]** or **[VIEW]**.

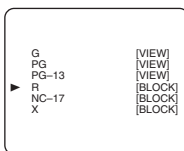

| Selection | Rating Category Explanations  |
|-----------|---|
| G         | General Audience  |
| PG        | Parental Guidance suggested.  |
| PG-13     | Unsuitable for children under 13                                    |
| R         | Restricted; under 17 requires accompanying parent or adult guardian |
| NC-17     | No one under 17 admitted  |
| X         | Mature audience only  |

- When you select a rating and set it to **[BLOCK]**, the higher ratings will be blocked automatically. The lower ratings will be available for viewing.
- When you set the lowest rating to **[VIEW]**, all other ratings will automatically be available for viewing.

### **5** Exit the V-Chip setting mode

Hit **[SETUP]** to exit the menu.

## **C** CHANGE ACCESS CODE

Follow steps **1** to **3** in the “V-CHIP SET UP” section on page 16.

### **4** Enter New code

Press **the Number buttons** to enter your desired access code in the “NEW CODE” space, then enter the same code in the “CONFIRM CODE” space. When completed, the menu will return to “V-CHIP SET UP”.

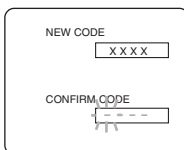

- Make sure you enter exactly the same new code in the “CONFIRM CODE” space as one in the “NEW CODE” space. If they are different, the “NEW CODE” space is cleared for redoing.

### **5** Exit the V-Chip setting mode

Hit **[SETUP]** to exit the menu.

#### **NOTE:**

- Your personal access code will be erased and will return to the default (0000) when a power failure occurs or when you turn off the power using a wall switch. If you have forgotten the code, unplug the power cord for 10 seconds to restore the access code to 0000.

## MENU LANGUAGE

TV

### **1** Select “LANGUAGE”

Hit **[SETUP]**.

Press **[▲/▼]** to point to “LANGUAGE”.

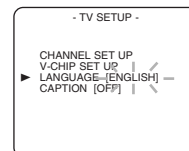

### **2** Select “ENGLISH”, “ESPAÑOL” or “FRANÇAIS”

Hit **[ENTER]** repeatedly to select “ENGLISH”, “ESPAÑOL”= Spanish or “FRANÇAIS”= French.

### **3** Exit the Language mode

Hit **[SETUP]** to exit the menu.

#### **NOTES:**

- This function effects only the language on the screen menu and not the audio source.
- If for some reason the menu is in Spanish or French, hit **[SETUP]**, press **[▲/▼]** to point to “IDIOMA [ESPAÑOL]” or “LANGAGE [FRANÇAIS]”, then hit **[ENTER]** repeatedly to select desired language, then hit **[SETUP]**.









## CABLE CHANNEL DESIGNATIONS

If you subscribe to cable TV, the channels are displayed as 1-125. Cable companies often designate channels with letters or letter-number combinations. Please check with your local cable company. The following is a chart of common cable channel designations.

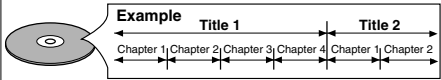
|              |      |      |      |      |      |      |      |      |      |      |      |      |      |      |      |
|--------------|------|------|------|------|------|------|------|------|------|------|------|------|------|------|------|
| CATV channel | 5A   | 2    | 3    | 4    | 5    | 6    | 7    | 8    | 9    | 10   | 11   | 12   | 13   | A    | B    |
| TV Display   | 1    | 2    | 3    | 4    | 5    | 6    | 7    | 8    | 9    | 10   | 11   | 12   | 13   | 14   | 15   |
| CATV channel | C    | D    | E    | F    | G    | H    | I    | J    | K    | L    | M    | N    | O    | P    | Q    |
| TV Display   | 16   | 17   | 18   | 19   | 20   | 21   | 22   | 23   | 24   | 25   | 26   | 27   | 28   | 29   | 30   |
| CATV channel | R    | S    | T    | U    | V    | W    | W+1  | W+2  | W+3  | W+4  | W+5  | W+6  | W+7  | W+8  | W+9  |
| TV Display   | 31   | 32   | 33   | 34   | 35   | 36   | 37   | 38   | 39   | 40   | 41   | 42   | 43   | 44   | 45   |
| CATV channel | W+10 | W+11 | W+12 | W+13 | W+14 | W+15 | W+16 | W+17 | W+18 | W+19 | W+20 | W+21 | W+22 | W+23 | W+24 |
| TV Display   | 46   | 47   | 48   | 49   | 50   | 51   | 52   | 53   | 54   | 55   | 56   | 57   | 58   | 59   | 60   |
| CATV channel | W+25 | W+26 | W+27 | W+28 | W+29 | W+30 | W+31 | W+32 | W+33 | W+34 | W+35 | W+36 | W+37 | W+38 | W+39 |
| TV Display   | 61   | 62   | 63   | 64   | 65   | 66   | 67   | 68   | 69   | 70   | 71   | 72   | 73   | 74   | 75   |
| CATV channel | W+40 | W+41 | W+42 | W+43 | W+44 | W+45 | W+46 | W+47 | W+48 | W+49 | W+50 | W+51 | W+52 | W+53 | W+54 |
| TV Display   | 76   | 77   | 78   | 79   | 80   | 81   | 82   | 83   | 84   | 85   | 86   | 87   | 88   | 89   | 90   |
| CATV channel | W+55 | W+56 | W+57 | W+58 | A-5  | A-4  | A-3  | A-2  | A-1  | W+59 | W+60 | W+61 | W+62 | W+63 | W+64 |
| TV Display   | 91   | 92   | 93   | 94   | 95   | 96   | 97   | 98   | 99   | 100  | 101  | 102  | 103  | 104  | 105  |
| CATV channel | W+65 | W+66 | W+67 | W+68 | W+69 | W+70 | W+71 | W+72 | W+73 | W+74 | W+75 | W+76 | W+77 | W+78 | W+79 |
| TV Display   | 106  | 107  | 108  | 109  | 110  | 111  | 112  | 113  | 114  | 115  | 116  | 117  | 118  | 119  | 120  |
| CATV channel | W+80 | W+81 | W+82 | W+83 | W+84 |      |      |      |      |      |      |      |      |      |      |
| TV Display   | 121  | 122  | 123  | 124  | 125  |      |      |      |      |      |      |      |      |      |      |

## ABOUT THE DISCS

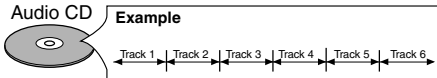
## PLAYABLE DISCS

| Playable discs                           | Mark (logo)   | Region code   | Recorded signals         | Disc size           | Disc types   |
|--|---|---|--------------------------|---------------------|--|
| DVD-Video<br>* 1,2,4,6,10,11             |  |  | Digital video<br>(MPEG2) | 12 cm<br>or<br>8 cm |  |
| DVD-RW<br>DVD-R<br>* 1,3,4,5,6<br>7,9,10 |  | -   |                          |                     |  |
| DVD+RW<br>DVD+R<br>* 1,3,4,5,6,8,9,10    |  | -   |                          |                     |  |
| Audio CD<br>* 4,6,10                     |  | -   | Digital audio            | 12 cm<br>or<br>8 cm |  |
| CD-RW<br>CD-R<br>* 4,5,6,9,10            |  |   |                          |                     |  |

**DVD** is a trademark of DVD Format/Logo Licensing Corporation.

**If you cannot play back a disc which bears one of the marks above, check the following notes.**

- \*1: This unit conforms to the NTSC color system. Discs recorded in other color systems such as PAL cannot be played back.
- \*2: Certain DVD-Video discs do not operate as described in this manual due to the intentions of the disc's producers.
- \*3: Discs recorded in the VR (Video Recording) format cannot be played back.
- \*4: Scratched or stained discs may not be played back.
- \*5: Some discs cannot be played back because of incompatible recording conditions, characteristics of the recorder or special properties of discs.
- \*6: You can play back discs which bear the marks above. If you use nonstandardized discs, this unit may not play them back. Even if they are played back, the sound or video quality will be compromised.
- \*7: You may play back the unfinalized DVD-R/RW disc recorded in the video format on our brand's DVD recorder. However, depending on the recording status of a disc, the disc may not be played back at all or normally (the picture or sound may not be smooth, etc.). In this case, you need to finalize the disc with the DVD recorder. Refer to the manual accompanying the DVD recorder.
- \*8: Only the discs recorded in the video format and finalized can be played back. Unfinalized discs cannot be played back. Depending on the recording status of a disc, the disc may not be played back at all or normally (the picture or sound may not be smooth, etc.).
- \*9: If there is too much recording space left on a disc (the used portion is less than 55mm across), it may not play back properly.
- \*10: Do not glue paper or put stickers on to the disc. These may damage the disc and the unit may not read it correctly.
- \*11: The number inside the symbol refers to a region of the world and a disc encoded in a specific region format can only be played back on unit with the same region code.

## UNPLAYABLE DISCS

- **NEVER play back the following discs. Otherwise, malfunction may result!**  
DVD-RAM / CD-I / Photo CD / Video CD / DVD with region codes other than 1 or ALL / DTS-CD / DVD-ROM for personal computers / CD-ROM for personal computers / MP3
- **On the following disc, the sound MAY NOT be heard.**  
Super Audio CD  
**NOTE:** Only the sound recorded on the normal CD layer can be delivered.  
The sound recorded on the high density Super Audio CD layer cannot be delivered.
- *Any other discs without compatibility indications*

# PLAYING A DISC

## BASIC PLAYBACK

DVD-V CD

### Getting started

- Turn on the power of amplifier and any other components, if necessary.

#### 1 Hit [POWER].

- The power will turn on.

#### 2 Hit [OPEN/CLOSE ▲] to open disc loading tray.

#### 3 Place the chosen disc in the tray, with the label facing up.

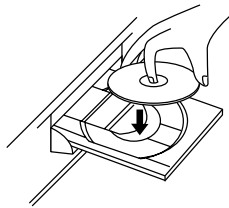

#### 4 Hit [PLAY ▷].

- The tray will close automatically and playback will then start from the first chapter or track of the disc.
- **Closing the disc tray manually or by hitting [OPEN/CLOSE ▲] also starts playback.**
- If the playback does not start automatically, hit [PLAY ▷].
- When you playback a DVD which features a title menu, it may appear on the screen. In this case, refer to “TITLE MENU” on this page.

#### 5 Hit [STOP ■] to stop playback.

### NOTES:

- When the DVD mode has been switched to the TV mode, the DVD mode shuts down first and then the TV picture and sound appears in about 4 seconds. Similarly, when [POWER] is hit to turn off in the DVD mode, this mode shuts down first and then the unit is turned off.
- A “prohibited icon” may appear at the top-right on the TV screen during operation, warning that a prohibited operation has been encountered by the DVD or the disc.
- With DVDs that use titles for playback program signals, playback may start from the second title or it may skip these titles.
- During the playback of a two layered disc, pictures may stop for a moment. This happens when the 1st layer switches to the 2nd layer. This is not a malfunction.



## GENERAL FEATURES

DVD-V

DVD may contain menus to navigate the disc and access special features. Press **the appropriate Number buttons** or [▲/▼/◀/▶] to highlight your selection in the DVD main menu and hit [ENTER] to confirm.

### NOTES:

- Select DVD mode by hitting [SELECT], then operate the DVD functions.
- Unless stated, all operations described are based on remote control use. Some operations can be carried out using the menu bar on the TV screen.

## DISC MENU

DVD-V

#### 1 Hit [DISC MENU].

- The DVD main menu will appear.
- If the feature is not available, ⊘ symbol may appear on the TV screen.
- If disc menu is available on the disc, audio language, subtitle options, chapters for the title and other options will appear for selection.

#### 2 Press [▲/▼/◀/▶] to select an item and hit [ENTER] to confirm selection.

## TITLE MENU

DVD-V

#### 1 Hit [TITLE].

- The title menu will appear.
- If the feature is not available, ⊘ symbol may appear on the TV screen.

#### 2 Press [▲/▼/◀/▶] to select an item, and hit [ENTER] to confirm selection.

### CALLING UP A MENU SCREEN DURING PLAYBACK

- Hit [DISC MENU] to call up the DVD menu.
- Hit [TITLE] to call up the title menu.

### NOTE:

- Contents of menu and corresponding menu operations may vary between discs. Refer to the manual accompanying the disc for details.

## RESUME

DVD-V CD

- 1 During playback, hit [STOP ■].
  - Resume message will appear on the TV screen.
- 2 Hit [PLAY ▷], playback will resume from the point at which playback was stopped.
  - To cancel resume, hit [STOP ■] twice.
  - The resume information stays on even when the power is turned off.

## PAUSE

DVD-V CD

- 1 During playback, hit [PAUSE III].
  - Playback will pause and sound will be muted.
- 2 To continue playback, hit [PLAY ▷].

## STEP BY STEP PLAYBACK

DVD-V

- 1 During playback, hit [PAUSE III].
  - Playback will pause and sound will be muted.
- 2 The disc goes forward by one frame each time [PAUSE III] is hit.
- 3 To exit step by step playback, hit [PLAY ▷].

## FAST FORWARD / FAST REVERSE

DVD-V CD

- 1 During playback, press [FWD ►►] or [REV ◄◄].
  - “►► 1” or “◄◄ 1” appears on the screen.
- 2 To select another speed, repeat step 1 until your required speed number appears on the screen.
  - For DVDs, fast forward/reverse search speed is different depending on the disc. Approximate speed is 1(×2), 2(×8), 3(×20), 4(×50) and 5(×100).
  - For Audio CDs approximate speed is 1(×2), 2(×8) and 3(×30).
  - When you press buttons on the front panel, press and hold [SEARCH ◄◄ / ►►] for a few seconds.
- 3 To return to normal playback, hit [PLAY ▷].

## SLOW FORWARD / SLOW REVERSE

DVD-V

- 1 During playback, hit [PAUSE III].
- 2 Press [FWD ►►] or [REV ◄◄].
  - “►► 1” or “◄◄ 1” appears on the screen.
- 3 To select another speed, repeat step 2 until your required speed number appears on the screen.
  - Slow forward or reverse speed varies with the disc. Approximate speed is 1(1/16), 2(1/8) and 3(1/2).
  - When you press buttons on the front panel, press and hold [SEARCH ◄◄ / ►►] for a few seconds.
- 4 To return to normal playback, hit [PLAY ▷].

## ZOOM

DVD-V

The Zoom function allows you to enlarge the video image and to pan through the enlarged image.

- 1 Hit [ZOOM] during playback.
  - Playback will continue.
- 2 Hit [ZOOM] repeatedly to select the required zoom factor: ZOOM1, ZOOM2, ZOOM3 or OFF.
- 3 Press [▲/▼/◄/►] to move the zoomed picture across the screen.
- 4 To exit zoom mode, hit [ZOOM] to OFF.

### NOTES:

- Zooming function does not work while disc menu is shown.
- Zooming function is not available on some discs.
- It may take several seconds to slide the zoomed picture.
- The picture may be distorted if you operate other functions repeatedly (ex. [PAUSE III] or [REV ◄◄], etc.) in the zoom mode.

# SEARCH FUNCTION

## TRACK SEARCH

CD

There are three ways to begin playback on an Audio CD at a specific track.

### Using the Number buttons

- 1 Press the Number buttons to enter the desired track number.
- Playback will start at the selected track.
  - For single digit tracks (1-9), press a single number (eg. track 3, hit [3]).
  - To play track 26, hit [+10], [2], [6].

### Using [SEARCH MODE]

- 1 Hit [SEARCH MODE].
- The track search display appears.
- 2 Within 30 seconds, select the desired track number using the Number buttons.
- For single digits hit [0] first, if the total track of the disc is 10 tracks or more.
  - Playback will start at the selected track.

### Using [SKIP <<< / >>>]

During playback, hit [SKIP >>>] to move the next track. Hit it repeatedly to skip subsequent tracks. Hit [SKIP <<<] to go back to beginning of the current track. Hit it repeatedly to go to the previous tracks.

- If [SKIP <<< / >>>] is pressed while the playback is paused, the playback will be paused again after skipping to the next track.

#### NOTE:

- [SKIP <<< / >>>] are not operative when playback is stopped.

## TITLE / CHAPTER SEARCH

DVD-V

- 1 Hit [SEARCH MODE] once for the Chapter search, twice for the Title search during playback.



- 2 Enter the desired chapter/title number using the Number buttons.
- Playback will start at the selected chapter or title.
  - Hit [CLEAR] to erase the incorrect input.
  - For single digits hit [0] first, if the total number of chapter or title of the disc is 10 or more.

## TIME SEARCH

DVD-V

CD

- 1 During playback, hit [SEARCH MODE] three times (CD: twice) to display the Time Search on the TV screen.
- 2 Within 30 seconds, enter a desired disc time using the Number buttons.
- Playback will start at the specified time.
  - Hit [CLEAR] to erase the incorrect input.
  - When there is no need to enter a number, "0" appears automatically. For example, "0 : 0 \_ : \_ \_" appears in the Time Search display if the total time of the track or title is less than 10 minutes.

## MARKER SETUP SCREEN

DVD-V

CD

Use markers to memorize your favorite places on a disc.

- 1 Hit [SEARCH MODE] four times (CD: three times) during playback.
- The display screen and Markers will appear on the TV screen.
- 2 Press [◀ / ▶] to select 1, 2, 3, 4, 5, 6, 7, 8, 9, or 10 and ensure that "... : : : : : ." appears in the display.
- 3 When you reach the desired point, hit [ENTER].
- The Title or Track and elapsed playing time will appear in the TV screen.
- 4 To return to the Marker later, hit [SEARCH MODE] four times (CD: three times) during playback and press [◀ / ▶] to choose the desired marker, then hit [ENTER].

#### NOTES:

- Operations which erase all Markers:
  - Opening the disc tray.
  - Turning off the power.
  - Hitting [SELECT].
  - Selecting "AC" at step 2 and hitting [ENTER].
- To clear a marker:
  - Press [◀ / ▶] to select a cursor on to the marker number and hit [CLEAR].
- You can mark up to 10 points.

- 5 Press [SEARCH MODE] or [RETURN] to exit.

# SPECIAL PLAYBACK FUNCTION

## REPEAT

REPEAT is available only during playback.

*REPEAT TITLE / CHAPTER*

DVD-V

To activate the repeat function, hit [REPEAT] during playback.

- The repeat mode changes as described below every time you hit the button.

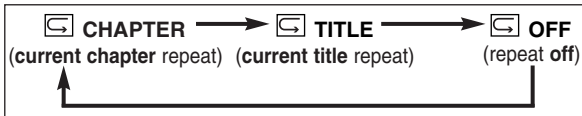

### NOTES:

- Repeat Title/Chapter is not available with some scenes.
- The REPEAT setting will be cleared when moving to other title or chapter.

*REPEAT TRACK*

CD

To activate the repeat function, hit [REPEAT] during playback.

- The repeat mode changes as described below every time you hit the button.



### NOTES:

- Repeat setting will be cleared when moving to other track.
- Repeat playback does not function during A-B repeat playback.

*A-B REPEAT*

DVD-V

CD

1 Hit [A-B] at your chosen starting point.

- “[A-B]” appears briefly on the TV screen.

2 Hit [A-B] again at your chosen end point.

- “[A-B]” appears briefly on the TV screen, and the repeat sequence begins.

3 To exit the sequence, hit [A-B].

### NOTES:

- The A-B repeat section can only be set within the current title (for DVDs) or current track (for Audio CDs).
- A-B repeat is not available with some scenes in DVD.
- To cancel the A point which was set, hit [CLEAR].
- A-B repeat playback does not function during title, chapter, track or all repeat playback.

## PROGRAM

CD

You may determine the order in which tracks will play.

1 In the stop mode, hit [MODE].

- The “PROGRAM” screen will appear.

2 Press [▲/▼] to select a track, then hit [ENTER].

- Hit [CLEAR] to erase the most recently entered track.
- If the entire Program cannot be displayed at once on a screen, “▶▶” appears to go to the next page and “◀◀” appears to go back to the previous page.

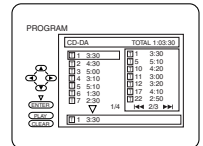

3 Repeat step 2 until you have selected all the tracks you want to play in the program.

4 Hit [PLAY ▷] to play the programmed tracks.

### NOTES:

- While the program is being played back, hitting [STOP ■] works as follows.
- Hit [STOP ■] once and then [PLAY ▷] again, playback will restart from the point where [STOP ■] was hit. (Program continued)
- Hit [STOP ■] twice and then [PLAY ▷] again, playback will restart from the track in the usual way. (Program canceled)
- Up to 99 tracks can be entered.
- To erase all tracks in the program at once, select “ALL CLEAR” at the bottom of the list at step 2.
- If you like to repeat the current track in the program, hit [REPEAT] several times until “[TRACK]” appears during playback. If you like to repeat the entire program hit [REPEAT] several times until “[ALL]” appears during playback.

## RANDOM PLAYBACK

CD

This function shuffles the playing order of tracks instead of playback in the sequence.

1 In the stop mode, hit [MODE] twice.

- “RANDOM” screen appears.

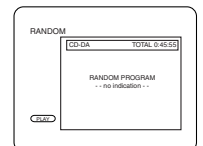

2 Hit [PLAY ▷] to start random playback.

### NOTE:

- If you like to repeat the current track in the random selection, hit [REPEAT] several times until “[TRACK]” appears during playback. If you like to repeat the entire random selection hit [REPEAT] several times until “[ALL]” appears during playback.

# CHANGING THE SETTINGS

## SUBTITLE LANGUAGE

DVD-V

The unit allows you to select a language for subtitles during DVD disc (if available) playback.

### 1 Hit [SUBTITLE] during playback.

- The subtitle language will appear on the display bar at the top of the TV screen.

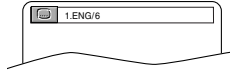

### 2 Hit [SUBTITLE] repeatedly to select your desired subtitle language.

### 3 To turn off subtitles, hit [SUBTITLE] repeatedly until "OFF" appears.

#### NOTES:

- Hitting [SUBTITLE] may not work on some DVDs with multiple subtitle languages. In this case, set it on the disc menu. (Operation varies between discs. Refer to the manual of the disc.)
- If the desired language is not shown after hitting [SUBTITLE] several times, the disc does not have subtitles in that language.
- When "NOT AVAILABLE" appears on the TV screen, it means no subtitle is recorded on the scene.
- If you choose a language that has a 3 letter language code, the code will be displayed every time you change the Subtitle language setting. If you choose any other languages, "---" will be displayed instead. (Refer to page 26.)

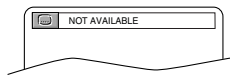

## AUDIO LANGUAGE

DVD-V

The unit allows you to select a language during DVD disc (if multi languages are available) playback.

### 1 Hit [AUDIO] during playback.

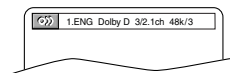

### 2 Hit [AUDIO] repeatedly to select your desired language.

#### NOTE:

- Hitting [AUDIO] may not work on some DVDs with multiple audio languages (e.g. DVDs which allow audio language setting on the disc menu).

## STEREO SOUND MODE

CD

### 1 Hit [AUDIO] repeatedly during playback to select between "STEREO", "L-ch" or "R-ch".

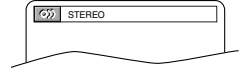

- STEREO - both right and left channels are active (stereo)
- L-ch - only left channel is active
- R-ch - only right channel is active

## CAMERA ANGLE

DVD-V

Some DVD discs contain scenes which have been shot simultaneously from various angles. You can change the camera angle when the "CAMERA" icon appears on the screen.

### 1 Hit [ANGLE] during playback.

- The selected angle will be displayed on the display bar at the top of the screen.

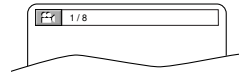

- If the "ANGLE ICON" setting is "OFF" in the "OTHERS" menu, the "CAMERA" icon will not appear. (Refer to page 28.)

### 2 Hit [ANGLE] repeatedly to select your desired angle.

## BLACK LEVEL SETTING

DVD-V

Adjust the Black Level Settings to make the black parts of the picture brighter.

### 1 Hit [MODE] during playback.



### 2 Hit [ENTER] to switch "ON/OFF".

- ON: Makes the dark parts brighter.
- OFF: Shows the original picture as recorded. (Initial setting)

### 3 Press [MODE] twice or [RETURN] to exit.

#### NOTE:

- The setting will be saved even if the unit is turned off.



# VIRTUAL SURROUND

DVD-V CD

You can enjoy surround-sound effect over two speakers on this unit.

- 1 Hit [MODE] twice (CD: once) during playback.



- 2 Hit [ENTER] to set it "1" (Natural effect), "2" (Emphasized effect) or "OFF".

- 3 Hit [MODE] to exit.

- You can also exit the menu by hitting [RETURN].

**NOTE: (for CD play only)**

- Virtual Surround will not be effective if the sound mode is set to something other than STEREO.

## THE ON-SCREEN INFORMATION

DVD-V CD

You can check the information about the current disc by hitting [DISPLAY].

### For DVD-Vs

- 1 Hit [DISPLAY] during playback to show current Chapter.

- The elapsed and remaining playing time of the current chapter will be displayed.

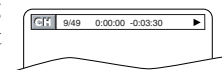

- 2 Hit [DISPLAY] again to show current Title.

- The elapsed and remaining playing time of the current title will be displayed.

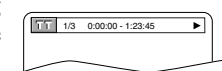

- 3 Hit [DISPLAY] again.

- The bit rate and the current repeat setting will be displayed.
- If you are playing a dual layered disc, the layer number will also be displayed (L0: Layer 0 is playing. L1: Layer 1 is playing).



- 4 Hit [DISPLAY] again to exit.



### For Audio CDs

- 1 Hit [DISPLAY] during playback to show the current Track.

- The elapsed and remaining playing time of the current track will be displayed.

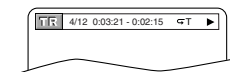

- 2 Hit [DISPLAY] again to show current Total Track.

- The elapsed and remaining playing time of the total track will be displayed.

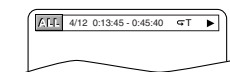

- 3 Hit [DISPLAY] again to exit.



**NOTE:**

- When you are playing a disc in PROGRAM or RANDOM mode, "[TR] PROGRAM" (or RANDOM) will be displayed at step 2.



# CHANGING THE DVD SET UP ITEMS

## CUSTOM MENU

DVD-V

You can change the DVD player's settings.

**1** Hit [SETUP] twice in the stop mode so that the DVD SETUP menu appears.

- Hit [▼] to select "CUSTOM" then hit [ENTER].

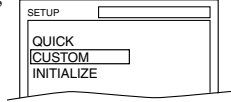

### NOTE:

- If the menu does not appear, hit [PLAY >] first, then hit [STOP ■]. Make sure the disc is in the stop mode, then slowly hit [SETUP] twice.

**2** Select the desired item.

- Press [▲/▼] to select the desired item then hit [ENTER] to confirm.

Refer to the pages below to set up each item.

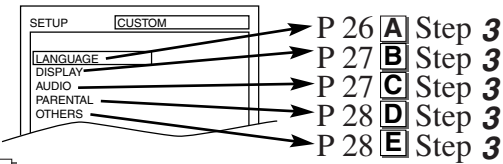

## A LANGUAGE SETTING

Follow steps **1** to **2** in the "CUSTOM MENU" section above.

**3** Press [▲/▼] to select the desired item then hit [ENTER].

### AUDIO:

Sets the audio language.

### SUBTITLE:

Sets the subtitle language.

### DISC MENU:

Sets the language for DVD menu.

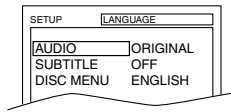

**4** Press [▲/▼] to select a setting then hit [ENTER].

- If "OTHER" is selected on the "AUDIO", "SUBTITLE" or "DISC MENU" screen, press four-digit number to enter the code for the desired language. (Refer to the language code list.)
- Only the languages supported by the disc can be selected.

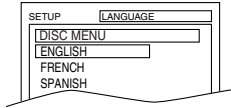
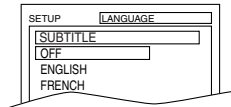
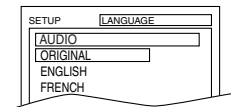

**5** Hit [SETUP] to exit the menu.

### NOTES:

- Language Setting for Audio and Subtitle are not valid for some discs due to default setting of the disc. In this case, set them by hitting [AUDIO] and [SUBTITLE]. (Refer to page 24.)
- If you select a language that is not supported by the disc, subtitle will automatically be set OFF and the first item of the audio languages will be automatically set.

| Language        | Code | Language         | Code |
|-----------------|------|------------------|------|
| <b>A-B</b>      |      | <b>L-N</b>       |      |
| Abkhazian       | 4748 | Laothian         | 5861 |
| Afar            | 4747 | Latin            | 5847 |
| Afrikaans       | 4752 | Latvian;Lettish  | 5868 |
| Albanian        | 6563 | Lingala          | 5860 |
| Amharic         | 4759 | Lithuanian       | 5866 |
| Arabic          | 4764 | Macedonian       | 5957 |
| Armenian        | 5471 | Malagasy         | 5953 |
| Assamese        | 4765 | Malay            | 5965 |
| Aymara          | 4771 | Malayalam        | 5958 |
| Azerbaijani     | 4772 | Maltese          | 5966 |
| Bashkir         | 4847 | Maori            | 5955 |
| Basque          | 5167 | Marathi          | 5964 |
| Bengali;Bangla  | 4860 | Moldavian        | 5961 |
| Bhutani         | 5072 | Mongolian        | 5960 |
| Bihari          | 4854 | Nauru            | 6047 |
| Bislama         | 4855 | Nepali           | 6051 |
| Breton          | 4864 | Norwegian [NOR]  | 6061 |
| Bulgarian       | 4853 | <b>O-R</b>       |      |
| Burmese         | 5971 | Occitan          | 6149 |
| Byelorussian    | 4851 | Oriya            | 6164 |
| <b>C-E</b>      |      | Oromo(Afan)      | 6159 |
| Cambodian       | 5759 | Panjabi          | 6247 |
| Catalan         | 4947 | Pashto;Pushto    | 6265 |
| Chinese [CHI]   | 7254 | Persian          | 5247 |
| Corsican        | 4961 | Polish           | 6258 |
| Croatian        | 5464 | Portuguese [POR] | 6266 |
| Czech           | 4965 | Quechua          | 6367 |
| Danish [DAN]    | 5047 | Rhaeto-Romance   | 6459 |
| Dutch [DUT]     | 6058 | Romanian [RUM]   | 6461 |
| English [ENG]   | 5160 | Russian [RUS]    | 6467 |
| Esperanto       | 5161 | <b>S</b>         |      |
| Estonian        | 5166 | Samoa            | 6559 |
| <b>F-H</b>      |      | Sangho           | 6553 |
| Faroese         | 5261 | Sanskrit         | 6547 |
| Fiji            | 5256 | Scots Gaelic     | 5350 |
| Finnish [FIN]   | 5255 | Serbian          | 6564 |
| French [FRE]    | 5264 | Serbo-Croatian   | 6554 |
| Frisian         | 5271 | Sesotho          | 6566 |
| Galician        | 5358 | Setswana         | 6660 |
| Georgian        | 5747 | Shona            | 6560 |
| German [GER]    | 5051 | Sindhi           | 6550 |
| Greek [GRE]     | 5158 | Singhalese       | 6555 |
| Greenlandic     | 5758 | Siswat           | 6565 |
| Guarani         | 5360 | Slovak           | 6557 |
| Gujarati        | 5367 | Slovenian        | 6558 |
| Hausa           | 5447 | Somali           | 6561 |
| Hebrew          | 5569 | Spanish [SPA]    | 5165 |
| Hindi           | 5455 | Sundanese        | 6567 |
| Hungarian [HUN] | 5467 | Swahili          | 6569 |
| <b>I-K</b>      |      | Swedish [SWE]    | 6568 |
| Icelandic [ICE] | 5565 | <b>T</b>         |      |
| Indonesian      | 5560 | Tagalog          | 6658 |
| Interlingua     | 5547 | Tajik            | 6653 |
| Interlingue     | 5551 | Tamil            | 6647 |
| Inupiak         | 5557 | Tatar            | 6666 |
| Irish [IRI]     | 5347 | Telugu           | 6651 |
| Italian [ITA]   | 5566 | Thai             | 6654 |
| Japanese [JPN]  | 5647 | Tibetan          | 4861 |
| Javanese        | 5669 | Tigrinya         | 6655 |
| Kannada         | 5760 | Tonga            | 6661 |
| Kashmiri        | 5765 | Tsonga           | 6665 |
| Kazakh          | 5757 | Turkish [TUR]    | 6664 |
| Kinyarwanda     | 6469 | Turkmen          | 6657 |
| Kirghiz         | 5771 | Twi              | 6669 |
| Kirundi         | 6460 | <b>U-Z</b>       |      |
| Korean [KOR]    | 5761 | Ukrainian        | 6757 |
| Kurdish         | 5767 | Urdu             | 6764 |
|                 |      | Uzbek            | 6772 |
|                 |      | Vietnamese       | 6855 |
|                 |      | Volapuk          | 6861 |
|                 |      | Welsh            | 4971 |
|                 |      | Wolof            | 6961 |
|                 |      | Xhosa            | 7054 |
|                 |      | Yiddish          | 5655 |
|                 |      | Yoruba           | 7161 |
|                 |      | Zulu             | 7267 |

If you choose a language that has a 3 letter language code, the code will be displayed every time you change the AUDIO or SUBTITLE language setting above. If you choose any other languages, '---' will be displayed instead. (3 letter language code is written in bracket.)

## **B** DISPLAY SETTING

Follow steps **1** to **2** in the “CUSTOM MENU” section on page 26.

**3** Press [▲/▼] to select the below items then hit [ENTER].

### TV MODE: **QUICK**

You can change certain aspects of the DVD display screens and on-screen messages on the TV screen.

- 4:3 LETTER BOX (default):

To show black bars on top and bottom of the screen.

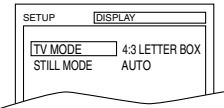

- 4:3 PAN & SCAN: To show a full height picture with both sides trimmed.

### STILL MODE:

This function allows you to adjust picture resolution and quality in the still mode.

- AUTO (default):

Automatically select the best resolution setting (FRAME or FIELD) based on the data characteristics of the pictures.

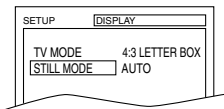

- FIELD: Select “FIELD” when the pictures are still unstable even if “AUTO” is selected. FIELD stabilizes the pictures, although the picture quality may become coarse due to the limited amount of data.
- FRAME: Select “FRAME” to display relatively motionless pictures in higher resolution. FRAME improves the picture quality, although it may unstabilize the pictures due to simultaneous output of two field data.

**4** Hit [SETUP] to exit the menu.

## **C** AUDIO SETTING

Choose the appropriate Audio settings for your equipment as it only affects during the playback of DVD discs.

Follow steps **1** to **2** in the “CUSTOM MENU” section on page 26.

**3** Press [▲/▼] to select the below items then hit [ENTER].

### DRC (Dynamic Range Control):

- To compress the range of soft to loud sound.
- The default setting is “ON”.

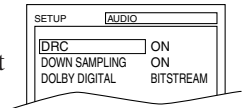

### DOWN SAMPLING:

- ON : Output in 48 kHz. (default)
- OFF : Output the original sound.

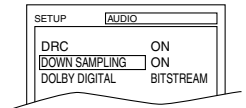

### When playing disc with copyright Protection

- If you select “OFF”, copyright protection will be activated and sound will be down sampled at 48kHz.

### DOLBY DIGITAL: **QUICK**

Set to “BITSTREAM” when the unit is connected to a Dolby Digital Decoder.

- BITSTREAM: Output a Dolby Digital signal (default)
- PCM: Convert the Dolby Digital to PCM (2 channel stereo)

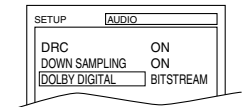

**4** Hit [SETUP] to exit the menu.

### **QUICK MENU**

- You can select the “TV MODE” or “DOLBY DIGITAL” from the QUICK menu quickly. To access the QUICK menu, select “QUICK” instead of “CUSTOM” at step **1** on page 26.

### **LANGUAGE SETTING FOR THE ON-SCREEN MENUS**

- You can access the TV SETUP menu by hitting [SETUP] from the DVD mode. Refer to “MENU LANGUAGE” on page 17 to change the language for the on-screen menus.

## D PARENTAL CONTROL

Parental Control limits the disc viewing that exceed your setting (with a password or playback will stop). This feature allows you to prevent discs with alternative scenes from being played by your children.

### PARENTAL LEVEL

Parental Level allows you to set the rating level of your DVD discs. Playback will stop if the disc's ratings exceed the level you set.

Follow steps **1** to **2** in the "CUSTOM MENU" section on page 26.

- 3 Enter your four-digit password then hit [ENTER].

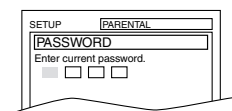

- 4 Press [▲/▼] to select "PARENTAL LEVEL" then hit [ENTER].

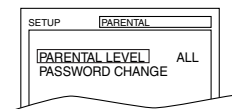

- 5 Press [▲/▼] to select the desired level then hit [ENTER].

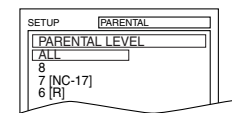

- 6 Hit [SETUP] to exit the menu.

### NOTES:

- When doing this for the first time, enter any 4 digits. (except for 4737) That number will be used as the password. (in the event you forget the password, see below)
- To change the password, press [▲/▼] to select "PASSWORD CHANGE" at step 4 then hit [ENTER]. Enter the four-digit password, then hit [ENTER].
- With some DVDs, it may be difficult to find if they are compatible with parental lock. Be sure to check if the parental lock function operates in the way that you have set.
- Record the password in case you forget it.

### CONTROL LEVELS

- **ALL**  
All parental lock is cancelled.
- **Level 8**  
DVD software of any grade (adult/general/children) can be played back.
- **Levels 7 to 2**  
Only DVD software intended for general use and children can be played back.
- **Level 1**  
Only DVD software intended for children can be played back, with those intended for adult and general use prohibited.

## IF YOU FORGET THE PASSWORD

- 1 Hit the Number buttons [4], [7], [3], [7] at step 3. Then enter your new password.

- Password will be cleared and parental level will be set to "ALL".

- 2 Proceed with steps 4 to 6 again.

## E OTHER SETTINGS

Follow steps **1** to **2** in the "CUSTOM MENU" section on page 26.

- 3 Press [▲/▼] to select the below items, then hit [ENTER].

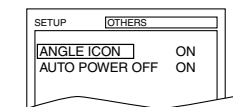

### ANGLE ICON:

- Hit [ENTER] repeatedly to turn Angle icon "ON" or "OFF".
- The default setting is "ON".

### AUTO POWER OFF:

- Hit [ENTER] repeatedly to turn Auto Power off "ON" or "OFF".
- The default setting is "ON" and the screen saver program starts when there is no input from the unit for 5 minutes in the stop mode. After the screen saver program is activated for 15 minutes, the power is automatically turned off.

- 4 Hit [SETUP] to exit the menu.

## INITIALIZE

DVD-V

This allows you to return all selections of SETUP (except for "PARENTAL" and **menu language**) to their default settings.

- 1 Hit [SETUP] twice in the stop mode so that the "INITIALIZE" menu appears.

- 2 Press [▲/▼] to select "INITIALIZE" then hit [ENTER].

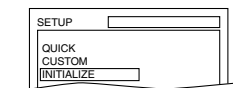

- 3 Press [▲/▼] to select "YES" then hit [ENTER] twice.

All the settings (except for "PARENTAL" and **menu language**) will be cleared.

- To cancel the initialization, select "NO".

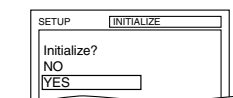

- 4 Hit [SETUP] to exit the menu.

# TROUBLESHOOTING GUIDE

If the unit does not perform properly when operated as instructed in this Owner's Manual, check the unit, consulting the following checklist.

| PROBLEM                                 | CORRECTIVE ACTION  |
|---|--|
| No power                                | <ul style="list-style-type: none"> <li>• Make sure the power plug is connected to an AC outlet.</li> <li>• Make sure the power is turned on.</li> </ul>  |
| No operation by infrared remote control | <ul style="list-style-type: none"> <li>• Check if the power plug is connected to an AC outlet.</li> <li>• Check the batteries in the remote control.</li> <li>• Aim the remote control directly at the remote sensor. If necessary, remove all the obstacles between the sensor and the remote control.</li> <li>• You have to be within 23 feet of the unit.</li> <li>• Check if the correct mode is selected. If not switch the mode by hitting [SELECT], whichever you need.</li> </ul> |

## TV Mode

Sometimes a performance problem can be easily solved by checking seemingly apparent but often overlooked possibilities. Before arranging for service, check these items. It could save your time and money.

| PROBLEM   | CORRECTIVE ACTION  |
|---|--|
| No picture or sound                                     | <ul style="list-style-type: none"> <li>• Make sure the AC cord is connected to an AC outlet.</li> <li>• Check antenna connection.</li> <li>• Hit [SELECT] to select TV mode. Then try other TV feature.</li> <li>• Let the unit program its tuner memory.</li> </ul>   |
| No picture or poor picture on the unit                  | <ul style="list-style-type: none"> <li>• Adjust direction or replace antenna.</li> <li>• Adjust picture controls.</li> <li>• Check for broken pin of the antenna cable.</li> </ul>   |
| No sound or poor sound                                  | <ul style="list-style-type: none"> <li>• Adjust volume control on remote control or main unit.</li> <li>• Hit [MUTE] to restore sound.</li> </ul>  |
| Bars On Screen  | <ul style="list-style-type: none"> <li>• If outside antenna is being used, check for broken wire.</li> <li>• Check for local interference.</li> </ul>  |
| Picture Distorted or Blurred                            | <ul style="list-style-type: none"> <li>• Try a new channel, if OK, then possible station trouble.</li> <li>• If outside antenna is being used, check for broken wire.</li> </ul>   |
| Picture Rolls Vertically<br>Lines or Streaks in Picture | <ul style="list-style-type: none"> <li>• Try a new channel, if OK, then possible station trouble.</li> <li>• If outside antenna is being used, check for broken wire.</li> <li>• Check for local interference.</li> </ul>  |
| No Color  | <ul style="list-style-type: none"> <li>• Try a new channel, if OK, then possible station trouble.</li> <li>• Is antenna connected to jack on the back of the set?</li> <li>• If outside antenna is being used, check for broken wire.</li> <li>• Adjust "COLOR" control.</li> </ul>  |
| Poor Reception on Some Channels<br>Ghosts in Picture    | <ul style="list-style-type: none"> <li>• Try a new channel, if OK, then possible station trouble.</li> <li>• Is antenna connected to jack on the back of the set?</li> <li>• If outside antenna is being used, check for broken wire.</li> <li>• Check for local interference.</li> </ul>  |
| Weak Picture  | <ul style="list-style-type: none"> <li>• Try a new channel, if OK, then possible station trouble.</li> <li>• Is antenna connected to jack on the back of the set?</li> <li>• If outside antenna is being used, check for broken wire.</li> <li>• Adjust "CONTRAST" &amp; "BRIGHT" control.</li> </ul>  |
| Sound OK, Picture Poor                                  | <ul style="list-style-type: none"> <li>• Try a new channel, if OK, then possible station trouble.</li> <li>• Is antenna connected to jack on the back of the set?</li> <li>• If outside antenna is being used, check for broken wire.</li> <li>• Check for local interference.</li> <li>• Adjust "CONTRAST" &amp; "BRIGHT" control.</li> </ul> |

| <b>PROBLEM</b>                          | <b>CORRECTIVE ACTION</b>  |
|---|---|
| Picture OK, Sound Poor                  | <ul style="list-style-type: none"> <li>• Try a new channel, if OK, then possible station trouble.</li> <li>• Check for local interference.</li> </ul>   |
| No operation by infrared remote control | <ul style="list-style-type: none"> <li>• Make sure the AC cord is connected to an AC outlet.</li> <li>• Check batteries in remote control.</li> </ul>   |
| Different color marks on screen         | <ul style="list-style-type: none"> <li>• Magnetism from nearby appliances and geomagnetism might affect the color of the TV picture. Move the unit away from the appliances, the unit can repair itself automatically. If you want to repair immediately, unplug the power cord, then plug it in again 30 minutes later or so. This automatically resets the unit.</li> </ul> |

| <b>CLOSED CAPTION PROBLEM</b>   | <b>POSSIBLE REMEDY</b>  |
|---|---|
| Misspelling in captions   | <ul style="list-style-type: none"> <li>• Error committed by the closed captioning production company. Possible in a live broadcast. Not in case of a prerecorded program.</li> </ul>  |
| Text is not shown in its entirety or a delay occurs from what is being said | <ul style="list-style-type: none"> <li>• A few seconds of delay is common for live broadcast.</li> <li>• Display capacity may not exceed 220 words per minute. If a dialogue exceeds that rate, selective editing is used to insure that the captions remain up-to-date with the current TV screen dialogue.</li> </ul> |
| Captions scrambled with white boxes   | <ul style="list-style-type: none"> <li>• Caused by interferences of building, power lines, thunderstorms, etc.</li> </ul>   |
| No captions in a program which must contain closed caption                  | <ul style="list-style-type: none"> <li>• The broadcast may use a time compression process to speed up the program. The decoder cannot read the compressed information and captions will be lost.</li> </ul>   |
| Black box in the TV screen  | <ul style="list-style-type: none"> <li>• You are in TEXT mode. Select a CAPTION mode (“C1”, “C2”) or Caption “OFF”.</li> </ul>  |

## DVD Mode

| PROBLEM   | CORRECTIVE ACTION   |
|---|---|
| No picture  | <ul style="list-style-type: none"> <li>• Insert a correct video disc that plays on this unit.</li> <li>• Hit [SELECT] to select DVD mode, then try other DVD feature.</li> </ul>  |
| Disc cannot be played   | <ul style="list-style-type: none"> <li>• Insert the disc.</li> <li>• Clean the disc.</li> <li>• Place the disc correctly, with the label side up.</li> <li>• Cancel the parental lock or change the control level.</li> </ul>                         |
| No sound  | <ul style="list-style-type: none"> <li>• Connect the audio cables firmly.</li> <li>• Turn the power of the audio component on.</li> <li>• Correct the audio output settings.</li> <li>• Correct the input settings on the audio component.</li> </ul> |
| No DTS audio is output  | <ul style="list-style-type: none"> <li>• This unit does not support DTS audio. This is not a malfunction.</li> </ul>  |
| Distorted picture   | <ul style="list-style-type: none"> <li>• There are some cases where pictures may be slightly distorted, which are not a sign of a malfunction.</li> <li>• Although pictures may stop for a moment, this is not a malfunction.</li> </ul>              |
| Audio or subtitle language does not match the set up  | <ul style="list-style-type: none"> <li>• The selected language is not available for audio or subtitles on the DVD. (This is not a malfunction.)</li> </ul>  |
| The camera angle cannot be changed  | <ul style="list-style-type: none"> <li>• The DVD does not contain sequences recorded from different camera angles. (This is not a malfunction.)</li> </ul>  |
| Audio or subtitle language cannot be changed  | <ul style="list-style-type: none"> <li>• The DVD does not contain audio source or subtitles in the selected language. (This is not a malfunction.)</li> </ul>   |
| “Prohibited icon” appears on the screen, prohibiting an operation   | <ul style="list-style-type: none"> <li>• That operation is prohibited by the unit or the disc. (This is not a malfunction.)</li> </ul>  |
| CD sound dropout<br>No CD reproduction<br>DVD picture dropout<br>DVD picture freeze<br>DVD picture in mosaic<br>No DVD reproduction | <ul style="list-style-type: none"> <li>• Scratched disc. Replace the disc with an unscratched one.</li> </ul>   |

### NOTES:

- Some functions are not available in specific modes, but this is not a malfunction. Read the description in this Owner’s Manual for details on correct operations.
- Playback from a desired track and random playback are not available during program playback.

# MAINTENANCE

## CABINET CLEANING

- Wipe the front panel and other exterior surfaces of the unit with a soft cloth immersed in lukewarm water and wrung dry.
- Never use a solvent or alcohol. Do not spray insecticide liquid near the unit. Such chemicals may cause damage and discoloration to the exposed surfaces.

## SERVICING

- Should your unit become inoperative, do not try to correct the problem by yourself. There are no user-serviceable parts inside. Turn off, unplug the power cord and **please call our help line mentioned on the front page**, to locate an Authorized Service Center.

## IF THE LASER OPTICAL PICKUP UNIT IS DIRTY

- If the unit still does not perform properly when it is operated, while referring to the relevant sections and to “TROUBLESHOOTING GUIDE” in this Owner’s Manual, the laser optical pickup unit may be dirty. Consult your dealer or an Authorized Service Center for inspection and cleaning of the laser optical pickup unit.

## DISC HANDLING

- Handle the discs so that fingerprints and dust do not adhere to the surfaces of the discs.

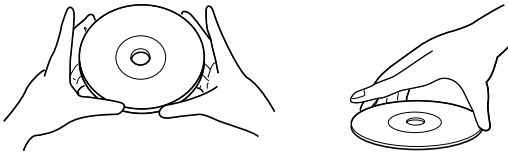

- Always store the disc in its protective case when it is not used.

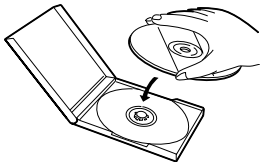

- To clean-off, use a soft cloth.
- Do not use a hard cloth since this will mar the disc.
- Wipe the disc in a straight line from center to edge.
- Never wipe with a circular motion.
- Do not use detergent or abrasive cleaning agents.

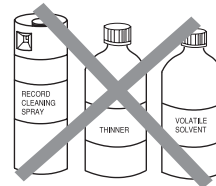
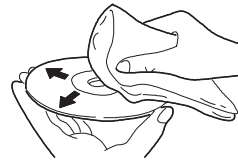



# SPECIFICATIONS

## GENERAL SPECIFICATIONS

### TV

|                        |   |
|------------------------|---|
| CRT:                   | 20 inch in-line gun,<br>90° deflection tube                 |
| Television system:     | NTSC-M  |
| Closed caption system: | §15.119/FCC   |
| Channel coverage:      |   |
| VHF:                   | 2 ~ 13  |
| UHF:                   | 14 ~ 69   |
| CATV:                  | 2 ~13, A ~ W,<br>W+1 ~ W+84,<br>A-5 ~ A-1, 5A               |
| Tuning System:         | 181 channel<br>frequency synthesized<br>tuning system       |
| Channel access:        | Direct access keyboard,<br>programmable<br>scan and up/down |

### DVD

|                       |                     |
|-----------------------|---------------------|
| Product type:         | DVD Player          |
| Discs:                | DVD video, Audio CD |
| Output signal format: | NTSC color          |

## ELECTRICAL SPECIFICATIONS

Sound output: 2 speakers, 1W, 8 ohm

## OTHER SPECIFICATIONS

|                                  |  |
|----------------------------------|--|
| Terminals                        |  |
| Antenna input:                   | VHF/UHF/CATV<br>75 ohm unbalanced (F-type)                           |
| Video input:                     | RCA connector × 1  |
| Audio L/R input:                 | RCA connector × 2  |
| Headphone:                       | 1/8" stereo (3.5 mm)   |
| Coaxial digital<br>audio output: | One pin jack,<br>500m Vpp (75 ohm)                                   |
| Remote control:                  | Digital encoded<br>infrared light system                             |
| Operating<br>temperature:        | 5°C to 40°C<br>(41°F~104°F)  |
| Power requirements:              | AC 120V, 60Hz  |
| Power consumption<br>(Maximum):  | 80W  |
| Picture tube:                    | 20" PF   |
| Dimensions:                      | H : 20-1/4" (514mm)<br>W : 20-3/16" (512mm)<br>D : 19-13/16" (503mm) |
| Weight:                          | 46.3 lbs. (21.0kg)   |

- Designs and specifications are subject to change without notice.
- If there is a discrepancy between languages, the default language will be English.

# INDICE

|   |    |
|---|----|
| ■ <b>INDICE</b> .....   | 34 |
| ■ <b>CONTROLES DE OPERACIÓN Y FUNCIONES</b> .....   | 34 |
| ■ <b>PREPARACIÓN PARA LA UTILIZACIÓN</b> .....  | 35 |
| CONEXIONES DE ANTENA/CABLE .....  | 35 |
| CONEXIÓN A TOMAS DE ENTRADA DELANTERAS  | 36 |
| CONEXIÓN A UN AMPLIFICADOR ESTÉREO<br>EQUIPADO CON TOMAS DE ENTRADA DIGITAL<br>(para DVD) ..... | 36 |
| CONEXIÓN A UN DECODIFICADOR DOLBY DIGITAL<br>(para DVD) .....                                   | 36 |
| PARA INSERTAR LAS PILAS .....   | 36 |

## SECCIÓN DE TV

|                                    |    |
|------------------------------------|----|
| PARA MIRAR UN PROGRAMA DE TV ..... | 37 |
| IDIOMA DEL MENÚ .....              | 37 |

## SECCIÓN DE DVD

|                           |    |
|---------------------------|----|
| REPRODUCCIÓN BÁSICA ..... | 38 |
| MENÚ DE DISCO .....       | 38 |
| REANUDACIÓN .....         | 38 |

## CONTROLES DE OPERACIÓN Y FUNCIONES

- Consulte la figura 1 de la página 8 para el panel frontal de la unidad
- Consulte la figura 2 de la página 8 para el mando a distancia
- Consulte la figura 3 de la página 9 para la vista posterior

- 1. Bandeja de carga del disco**
- 2. Toma de entrada VIDEO**  
Conecte aquí la toma de salida de vídeo de una videocámara o de una videgrabadora.
- 3. Tomas de entrada AUDIO L/R**  
Conecte aquí las tomas de salida de audio de una videocámara o de una videgrabadora.
- 4. Botón POWER**  
Presione para encender y apagar la unidad.
- 5. Botones VOLUME (VOL.) ▲ / ▼**  
Presione para controlar el nivel de volumen del DVD y el televisor.
- 6. Botones CHANNEL (CH.) ▲ / ▼**  
Utilice para seleccionar canales memorizados.
- 7. Ventanilla del sensor de mando a distancia**
- 8. Botón STOP ■**  
Detiene la operación del disco.
- 9. Botones SKIP ◀◀ / ▶▶**  
Presione una vez para omitir capítulos o pistas y desplazarse a un punto específico.  
**Botones SEARCH ◀◀ / ▶▶ (Panel frontal)**  
Mantenga el botón presionado para cambiar la velocidad de reproducción en avance o retroceso.
- 10. Botón PLAY ▶**  
Inicia la reproducción del contenido del disco.
- 11. Botón PAUSE II**  
Hace una pausa en la reproducción del disco.
- 12. Botón OPEN/CLOSE ▲**  
Presione para insertar un disco en la bandeja o retirarlo de ella.
- 13. Toma HEADPHONE**  
Para conectar auriculares (no suministrados) y escuchar en privado.
- 14. Botón PICTURE**  
Presione para ajustar la imagen.
- 15. Botones Numéricos**  
**Modo TV:**  
Presione dos cifras para acceder directamente al canal deseado.  
No olvide presionar [0] antes de elegir un canal de una sola cifra.  
**Botón +100**  
Presione para seleccionar canales de televisión por cable cuyo número sea superior a 99.  
**Modo DVD:**  
Presione para introducir el número deseado.  
**Botón +10**  
Presione para introducir números superiores a 9.
- 16. Botón SLEEP**  
Utilise para ajustar el temporizador de dormir.
- 17. Botón DISPLAY**  
**Modo TV:**  
Indica el número del canal en la pantalla del televisor.  
**Modo DVD:**  
Indica el estado actual en la pantalla del televisor.
- 18. Botón SETUP**  
Presione para entrar o salir del menú de configuración de televisor o DVD.
- 19. Botón TITLE**  
Para visualizar el menú de títulos.
- 20. Botón CLEAR**  
Para cancelar o borrar un ajuste entrado actualmente.
- 21. Botón MODE**  
Presione para llamar la pantalla de la reproducción programada o la de reproducción aleatoria en el modo de parada.  
Presione para llamar la pantalla de ajuste del nivel del negro o la pantalla de sonido ambiental durante la reproducción.
- 22. Botón SEARCH MODE**  
Presione para localizar un punto deseado.
- 23. Botón AUDIO**  
Presione para seleccionar un modo de sonido o idioma de audio deseado.
- 24. Botón SUBTITLE**  
Presione para seleccionar el idioma de subtítulos deseado.
- 25. Botón REPEAT**  
Repite la reproducción del disco, título, capítulo o pista actual.
- 26. Botón ANGLE**  
Presione para cambiar el ángulo de la cámara y ver la secuencia que se está reproduciendo desde un ángulo diferente (si existe).

27. **Botón A-B**  
Repite la reproducción de una sección seleccionada.
28. **Botón RETURN**  
Permite volver a la pantalla anterior en el menú de configuración.
29. **Botón ENTER**  
Presione para establecer un ajuste.
30. **Botones ▲/▼/◀/▶**  
**Modo TV:**  
Presione para seleccionar un modo de ajuste en el menú que aparece en la pantalla del televisor. Presiónelos también para seleccionar opciones o establecer ajustes en un menú en particular.  
**Modo DVD:**  
Presione para hacer una selección en el menú.
31. **Botón DISC MENU**  
Muestra menú del DVD.
32. **Botón REV ◀◀**  
Presione para mover la imagen de DVD en retroceso rápido en o en cámara lenta en retroceso.  
**Botón FWD ▶▶**  
Presione para mover en avance rápido o en cámara lenta en el disco.

33. **Botón ZOOM**  
Amplía parte de la imagen reproducida de un DVD.
34. **Botón MUTE**  
Suprime la salida de sonido. Presiónelo de nuevo para restablecer el sonido.
35. **Botón SELECT**  
Presione para cambiar al modo TV, modo de entrada externa o modo de DVD.
36. **Toma COAXIAL**  
Conecte solamente a la entrada digital de un amplificador externo o decodificador (para audio de DVD solamente).
37. **Toma ANT.**  
Conecte a una antena, sistema de televisión por cable o sistema de satélite.
38. **Cable eléctrico**  
Conéctelo a un toma de CA estándar (120 V/60 Hz).  
**NOTA:**
- Antes de conectar el cable eléctrico a una toma de CA, retírelo del gancho para evitar dañarlo.

## PREPARACIÓN PARA LA UTILIZACIÓN

### CONEXIONES DE ANTENA/CABLE

Consulte la figura 4 de la página 10

#### Nota para el instalador de sistemas CATV

Esta nota tiene la finalidad de llamar la atención del instalador de sistemas CATV para que tenga en cuenta el Artículo 820-40 de la NEC, que proporciona recomendaciones para hacer una conexión a tierra apropiada y, en particular, especifica que la tierra del cable debe conectarse al sistema de puesta a tierra del edificio, tan cerca del punto de entrada del cable como sea posible.

#### NOTA:

Antes de enchufar la antena a la toma ANT. de la unidad, compruebe que la clavija no esté doblada. Si esta doblada, póngala derecha como se muestra en la ilustración, y luego conéctela en la toma ANT. de la unidad.

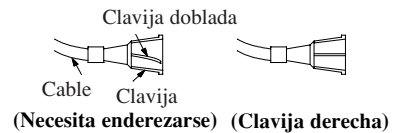

#### NOTA:

- Para su seguridad y para evitar que se dañe la unidad, desenchufe el cable de antena de la toma ANT. antes de mover la unidad.

## CONEXIÓN A TOMAS DE ENTRADA DELANTERAS

Cuando vea un programa grabado en otra fuente (videograbadora o videocámara), utilice las tomas de entrada AUDIO/VIDEO de la parte delantera de la unidad.

Conecte las tomas de salida de audio/vídeo de otra fuente a las tomas AUDIO L/R y VIDEO de esta unidad.

Después, presione [SELECT] o [CH. ▲/▼] hasta que aparezca "AUX" en la pantalla.

Consulte la figura 5 de la página 11

### NOTA:

- Cuando conecte una videograbadora monofónica (otra fuente) a esta unidad, conecte la toma de salida de audio de la videograbadora monofónica (otra fuente) a la toma AUDIO L de esta unidad. El audio saldrá igualmente por los canales izquierdo y derecho.

## CONEXIÓN A UN AMPLIFICADOR ESTEREO EQUIPADO CON TOMAS DE ENTRADA DIGITAL (para DVD)

Utilice un cable digital coaxial de audio (disponible en el comercio) para hacer las conexiones de audio.

Conexión a un amplificador equipado con tomas de entrada digital, platina MD o platina DAT.

Consulte la figura 6 de la página 11

### NOTAS:

- La fuente de audio de un disco grabado en formato de sonido envolvente Dolby Digital de 5,1 canales no se puede grabar como sonido digital mediante una platina MD o DAT.
- Asegúrese de apagar todos los componentes del sistema antes de conectar otro componente.
- Consulte los manuales de instrucciones de los componentes que va a conectar a la unidad.
- Ajuste la función "DOLBY DIGITAL" a "PCM" para salida de audio en el modo de configuración. La reproducción en una unidad utilizando ajustes incorrectos puede generar ruido y distorsión, y también puede provocar daños a los altavoces.

## CONEXIÓN A UN DECODIFICADOR DOLBY DIGITAL (para DVD)

Si utiliza esta unidad para reproducir un disco DVD en un formato de sonido envolvente Dolby Digital de 5,1 canales, la unidad dará salida a un flujo de datos DOLBY DIGITAL desde su toma COAXIAL. Si conecta la unidad a un decodificador Dolby Digital, podrá disfrutar de una tonalidad más convincente y real, con un sonido envolvente potente y de alta calidad similar al de los cines.

Utilice cables digitales coaxiales de audio (disponibles en el comercio) para hacer las conexiones de audio.

Consulte la figura 7 de la página 12

### NOTAS:

- Asegúrese de apagar todos los componentes del sistema antes de conectar otro componente.
- Consulte los manuales de instrucciones de los componentes que va a conectar a la unidad.
- Si conecta un decodificador Dolby Digital, ajuste la función "DOLBY DIGITAL" a "BITSTREAM" para salida de audio en el modo de configuración.
- A menos que se haga la conexión a un decodificador Dolby Digital, ajuste la función "DOLBY DIGITAL" a "PCM" para salida de audio en el modo de configuración. La reproducción en una unidad utilizando ajustes incorrectos puede generar ruido y distorsión, y también puede provocar daños a los altavoces.

Fabricado bajo licencia de Dolby Laboratories. "Dolby" y el símbolo de la doble D son marcas comerciales de Dolby Laboratories.

## PARA INSERTAR LAS PILAS

- 1) Abra la cubierta del compartimiento de las pilas empujando la cubierta del mando a distancia en el sentido de la flecha.
- 2) Inserte 2 pilas "AA" en el compartimiento de las pilas, en el sentido indicado por las marcas de polaridad (+/-).
- 3) Vuelva a poner la cubierta.

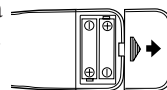

## SECCIÓN DE TV

### PARA MIRAR UN PROGRAMA DE TV

TV

#### 1 Enchufe el cable eléctrico

Enchufe el cable eléctrico de la unidad en un tomacorriente de CA del hogar.

#### NOTA:

- Si aparecen números en la esquina de la pantalla, presione [POWER] sin desenchufar el cable eléctrico.

#### 2 Encienda la unidad

Presione [POWER] para encender la unidad.

#### 3 Seleccione el número de canal

Presione [CH. ▲/▼] o los botones numéricos para seleccionar su número de canal deseado.

#### Nota para el uso de los botones numéricos:

- Debe colocar un cero antes de los números de canal de una sola cifra (por ejemplo: 02, 03, 04, etc.).
- Cuando seleccione canales de cable de más de 99, presione primero [+100] y después las dos últimas cifras. (Ejemplo: para seleccionar el canal 125, primero presione [+100] y después presione [2] y [5].)

#### 4 Ajuste el sonido

Presione [VOL. ▲/▼] para ajustar el volumen.

Presione [MUTE] para silenciar instantáneamente el sonido.

Presione nuevamente para recuperar el nivel de sonido anterior.

#### NOTA:

- Si presione [CH. ▲/▼] en el modo DVD, puede cambiar los canales de TV. Incluso si apaga la unidad en el modo DVD, cuando vuelva a encender, volverá al modo TV.

### PARA VER CANALES DE CABLE O SATELITE

- Si la unidad está conectada a una caja de cable o caja de satélite, presione [CH. ▲/▼] para seleccionar CH3 o CH4 de acuerdo con el ajuste de canal de salida del dispositivo y seleccione el canal deseado en el dispositivo.

### PARA VER UNA ENTRADA EXTERNA

- Cuando se conecta un equipo externo en las tomas de entrada AUDIO/VIDEO frontales, presione [SELECT] o [CH. ▲/▼] repetidamente hasta que aparezca "AUX" en la pantalla.

### IDIOMA DEL MENÚ

TV

#### 1 Seleccione "LANGUAGE"

Presione [SETUP].

Presione [▲/▼] para apuntar a "LANGUAGE".

#### 2 Seleccione "ENGLISH", "ESPAÑOL" o "FRANÇAIS"

Presione [ENTER] repetidamente para seleccionar "ENGLISH" = inglés, "ESPAÑOL" o "FRANÇAIS" = francés.

#### 3 Salga del modo de idioma

Presione [SETUP] para salir del menú.

#### NOTAS:

- Esta función afecta sólo el idioma en el menú de la pantalla y no la fuente de audio.
- Si por alguna razón, el menú está en francés, presione [SETUP], presione [▲/▼] para apuntar al "LANGAGE [FRANÇAIS]" y presione [ENTER] repetidamente para seleccionar el idioma deseado y presione [SETUP].

## SECCIÓN DE DVD

### REPRODUCCIÓN BÁSICA

DVD-V CD

#### Para empezar

- Conecte la alimentación del amplificador y otros componentes, si es necesario.

#### 1 Presione [POWER].

- La alimentación se conectará.

#### 2 Presione [OPEN/CLOSE ▲] para abrir la bandeja de carga del disco.

#### 3 Ponga el disco deseado en la bandeja, con la etiqueta hacia arriba.

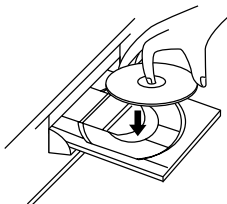

#### 4 Presione [PLAY ▷].

- La bandeja se cerrará automáticamente y la reproducción comenzará desde el primer capítulo o pista del disco.
- **La reproducción también empieza cerrando manualmente la bandeja del disco o presionando [OPEN/CLOSE ▲].**
- Si la reproducción no comienza automáticamente, presione [PLAY ▷].
- Cuando reproduzca un DVD que tenga grabado un menú de títulos, el menú podrá aparecer en la pantalla.

#### 5 Presione [STOP ■] para detener la reproducción.

### MENÚ DE DISCO

DVD-V

#### 1 Presione [DISC MENU].

- Aparecerá el menú principal de DVD.
- Si no existe la función, puede aparecer el símbolo  en la pantalla de TV.
- Si el menú de disco existe en el disco, aparecerán el idioma de audio, opciones de subtítulo, capítulos para el título y otras opciones para su selección.

#### 2 Presione [▲/▼/◀/▶] para hacer una selección y presione [ENTER] para confirmar la selección.

### REANUDACIÓN

DVD-V CD

#### 1 Durante la reproducción, presione [STOP ■].

- Aparecerá el mensaje de continuación en la pantalla de TV.

#### 2 Presione [PLAY ▷], la reproducción continuará desde el punto donde se paró la reproducción.

- Para cancelar la continuación, presione dos veces [STOP ■].
- La información de continuación permanece activada incluso cuando apaga el interruptor principal.

MEMO

---

## FUNAI CORPORATION LIMITED WARRANTY

FUNAI CORP. will repair this product, free of charge in the USA in the event of defect in materials or workmanship as follows:

### **DURATION:**

**PARTS:** FUNAI CORP. will provide parts to replace defective parts without charge for one (1) year from the date of original retail purchase. Two (2) years for Picture Tube. Certain parts are excluded from this warranty.

**LABOR:** FUNAI CORP. will provide the labor without charge for a period of ninety (90) days from the date of original retail purchase.

### **LIMITS AND EXCLUSIONS:**

This warranty is extended only to the original retail purchaser. A purchase receipt or other proof of original retail purchase will be required together with the product to obtain service under this warranty.

This warranty shall not be extended to any other person or transferee.

This warranty is void and of no effect if any serial numbers on the product are altered, replaced, defaced, missing or if service was attempted by an unauthorized service center. This FUNAI CORPORATION Limited warranty does not apply to any product not purchased and used in the United States.

This warranty only covers failures due to defects in material or workmanship which occurs during normal use. It does not cover damage which occurs in shipment, or failures which are caused by repairs, alterations or product not supplied by FUNAI CORP., or damage which results from accident, misuse, abuse, mishandling, misapplication, alteration, faulty installation, improper maintenance, commercial use such as hotel, rental or office use of this product or damage which results from fire, flood, lightning or other acts of God.

**THIS WARRANTY DOES NOT COVER PACKING MATERIALS, ANY ACCESSORIES (EXCEPT REMOTE CONTROL), ANY COSMETIC PARTS, COMPLETE ASSEMBLY PARTS, DEMO OR FLOOR MODELS.**

FUNAI CORP. AND ITS REPRESENTATIVES OR AGENTS SHALL IN NO EVENT BE LIABLE FOR ANY GENERAL, INDIRECT OR CONSEQUENTIAL DAMAGES ARISING OUT OF OR OCCASIONED BY THE USE OF OR THE INABILITY TO USE THIS PRODUCT. THIS WARRANTY IS MADE IN LIEU OF ALL OTHER WARRANTIES, EXPRESS OR IMPLIED, AND OF ALL OTHER LIABILITIES ON THE PART OF FUNAI. ALL OTHER WARRANTIES INCLUDING THE WARRANTY OF MERCHANTABILITY AND FITNESS FOR A PARTICULAR PURPOSE, ARE HEREBY DISCLAIMED BY FUNAI AND ITS REPRESENTATIVES IN THE UNITED STATES. ALL WARRANTY INSPECTIONS AND REPAIRS MUST BE PERFORMED BY A FUNAI AUTHORIZED SERVICE CENTER. THIS WARRANTY IS ONLY VALID WHEN THE UNIT IS CARRIED-IN TO A FUNAI AUTHORIZED SERVICE FACILITY.

### **IMPORTANT:**

THIS LIMITED WARRANTY GIVES YOU SPECIFIC LEGAL RIGHTS. YOU MAY HAVE OTHER RIGHTS THAT VARY FROM STATE TO STATE. IF, AT ANY TIME DURING THE WARRANTY PERIOD, YOU ARE UNABLE TO OBTAIN SATISFACTION WITH THE REPAIR OF THIS PRODUCT, PLEASE CONTACT FUNAI CORP.

### **ATTENTION:**

FUNAI CORP. RESERVES THE RIGHT TO MODIFY ANY DESIGN OF THIS PRODUCT WITHOUT PRIOR NOTICE.

**To locate your nearest Authorized Service Center or for general service inquiries, please call or write to the following:**

**FUNAI CORPORATION, INC.  
SERVICE CENTER**

19900 Van Ness Avenue, Torrance, CA 90501

**Tel :1-800-242-7158**

**<http://www.Symphonic.us>**

Head Office: 100 North Street, Teterboro, NJ 07608

**PLEASE DO NOT SHIP YOUR UNIT TO THE TETERBORO ADDRESS.**