

OWNER'S MANUAL

CD CHANGER

CD5800

Symphonic

CONTENTS

"IMPORTANT SAFEGUARDS"	2
FEATURES	4
OPERATING CONTROLS AND FUNCTIONS	5
REMOTE CONTROL OPERATION	6
PREPARATION.....	7
INSTALLING THE BATTERIES.....	7
OPERATION	8
LOADING DISC.....	8
LOADING CDS WITHOUT STOPPING PLAY- BACK	8
NORMAL PLAYBACK	9
CHOOSING A SPECIFIC TRACK.....	9
MANUAL SEARCH.....	9
PROGRAMMING PLAY	10
REPEAT PLAY.....	11
Repeat a Desired Track	11
REPEAT ALL THE DISCS	11
REPEAT PROGRAMMED TRACKS	11
RANDOM PLAY	11
DISPLAY	12
CARE AND MAINTENANCE	13
DISC HANDLING.....	13
CLEAN CABINET AND PANELS WHEN DIRTY	13
TROUBLESHOOTING GUIDE.....	14
SPECIFICATIONS	14
AUDIO	14
SIGNAL FORMAT.....	14
PICK-UP.....	14
GENERAL	14
ACCESSORIES	14

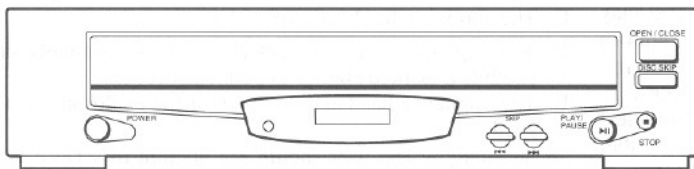

Memote #
N9170UD

IF YOU NEED ADDITIONAL ASSISTANCE FOR SET-
UP OR OPERATING AFTER READING OWNER'S
MANUAL, PLEASE CALL TOLL FREE
1-800-242-7158

Please read before using this equipment

"IMPORTANT SAFEGUARDS"

1. Read Instructions – All the safety and operating instructions should be read before the appliance is operated.
2. Retain Instructions – The safety and operation instructions should be retained for future reference.
3. Heed Warnings – All warnings on the appliance and in the operating instructions should be adhered to.
4. Follow Instructions – All operating and use instructions should be followed.
5. Water and Moisture – The appliance should not be used near water, for example, near a bathtub, washbowl, kitchen sink, laundry tub, in a wet basement, or near a swimming pool, etc.
6. Carts and Stands – The appliance should be used only with a cart or stand that is recommended by the manufacturer.
An appliance and cart combination should be moved with care. Quick stops, excessive force, and uneven surfaces may cause the appliance and cart combination to overturn.
7. Wall or Ceiling Mounting – The appliance should be mounted to a wall or ceiling only as recommended by the manufacturer.
8. Ventilation – The appliance should be situated so that its location or position does not interfere with its proper ventilation. For example, the appliance should not be situated on a bed, sofa, rug, or similar surface that may block the ventilation openings; or, placed in a built-in installation, such as a bookcase or cabinet that may impede the flow of air through the ventilation openings.
9. Heat – The appliance should be situated away from heat sources such as radiators, heat registers, stoves, or other appliances (including amplifiers) that produce heat.
10. Power Source – The appliance should be connected to a power supply only of the type described in the operating instructions or as marked on the appliance.

PORTABLE CART WARNING
(Symbol provided by RETAC)



11. Grounding or Polarization – This product is equipped with a polarized alternating-current line plug (a plug having one blade wider than the other). This plug will fit into the power outlet only one way. This is a safety feature. If you are unable to insert the plug fully into the outlet, try reversing the plug. If the plug should still fail to fit, contact your electrician to replace your obsolete outlet. Do not defeat the safety purpose of the polarized plug.
12. Power-Cord Protection – Power-supply cords should be routed so that they are not likely to be walked on or pinched by items placed upon or against them, paying particular attention to cords at plugs, convenience receptacles, and the point where they exit from the appliance.
13. Cleaning – The appliance should be cleaned only as recommended by the manufacturer.
14. Power Lines – An outdoor antenna should be located away from power lines.
15. Non-use Periods – The power cord of the appliance should be unplugged from the outlet when left unused for a long period of time.
16. Object and Liquid Entry – Care should be taken so that objects do not fall and liquids are not spilled into the enclosure through openings.
17. Damage Requiring Service – The appliance should be serviced by qualified service personnel when:
 - A. The power-supply cord or the plug has been damaged; or
 - B. Objects have fallen, or liquid has spilled into the appliance; or
 - C. The appliance has been exposed to rain; or
 - D. The appliance does not appear to operate normally or exhibits a marked change in performance; or
 - E. The appliance has been dropped, or the enclosure damaged.
18. Servicing – The user should not attempt to service the appliance beyond that described in the operating instructions. All other servicing should be referred to qualified service personnel.

WARNING:

TO REDUCE THE RISK OF FIRE OR ELECTRIC SHOCK, DO NOT EXPOSE THIS APPLIANCE TO RAIN OR MOISTURE.



CAUTION
RISK OF ELECTRIC SHOCK
DO NOT OPEN



CAUTION:

TO REDUCE THE RISK OF ELECTRIC SHOCK, DO NOT REMOVE COVER (OR BACK). NO USER-SERVICEABLE PARTS INSIDE. REFER SERVICING TO QUALIFIED SERVICE PERSONNEL.

LASER SAFETY

This unit employs a laser. Only a qualified service person should remove the cover or attempt to service this device, due to possible eye injury.

"**CAUTION:** USE OF CONTROLS OR AJUSTMENTS, OR PROCEDURES OTHER THAN THOSE SPECIFIED HEREIN MAY RESULT IN HAZARDOUS RADIATION EXPOSURE."

DANGER: INVISIBLE LASER RADIATION WHEN OPEN AND INTERLOCK FAILED OR DEFEATED. AVOID DIRECT EXPOSURE TO BEAM.

LOCATION: INSIDE, NEAR THE DECK MECHANISM.



The lightning flash with arrowhead symbol, within an equilateral triangle, is intended to alert the user to the presence of uninsulated "dangerous voltage" within the product's enclosure that may be of sufficient magnitude to constitute a risk of electric shock to persons.



The exclamation point within an equilateral triangle is intended to alert the user to the presence of important operating and maintenance (servicing) instructions in the literature accompanying the appliance.

RADIO-TV INTERFERENCE

This equipment has been tested and found to comply with the limits for a Class B digital device, pursuant to Part 15 of the FCC Rules. These limits are designed to provide reasonable protection against harmful interference in a residential installation. This equipment generates, uses, and can radiate radio frequency energy and, if not installed and used in accordance with the instructions, may cause harmful interference to radio communications. However, there is no guarantee that interference will not occur in a particular installation. If this equipment does cause harmful interference to radio or television reception, which can be determined by turning the equipment off and on, the user is encouraged to try to correct the interference by one or more of the following measures:

- 1) Reorient or relocate the receiving antenna.
- 2) Increase the separation between the equipment and receiver.
- 3) Connect the equipment into an outlet on a circuit different from that to which the receiver is connected.
- 4) Consult the dealer or an experienced radio/TV technician for help.

	Date of Purchase
	Dealer Purchase from
	Dealer Address
	Dealer Phone No.
	Model No.
	Serial No.

FEATURES

This Compact Disc Changer has a special automatic disc loading system that can hold up to five discs. This lets you select more music for continuous play and gives you more variety of music without having to remove and load discs.

- **Eight-Times Oversampling with Digital Filtering** — further improves the disc's sound by multiplying the standard 44.1 kHz sampling rate by eight and using a digital filter to reduce or eliminate high-frequency distortion.
- **Sequence Programming** — allows you to program up to 32 tracks to play in any order you choose.
- **Audible Search** — helps you locate a particular section of the music by playing the disc rapidly in either a forward or reverse direction.
- **Automatic Search Music System** — allows you to quickly locate and play any track on a disc.
- **IR Remote Control** — allows you to control the CD Changer from a remote location.
- **Tri-Spot Pickup Servo System** — helps ensure perfect tracking of your discs.
- **Repeat Play** — allows you to automatically repeat a single track, an entire CD, multiple CDs, a series of programmed tracks.
- **Random Play** — randomly selects tracks on loaded CDs and plays them.

FCC WARNING- This equipment may generate or use radio frequency energy. Changes or modifications to this equipment may cause harmful interference unless the modifications are expressly approved in the instruction manual. The user could lose the authority to operate this equipment if an unauthorized change or modification is made.

The serial number of this product may be found on the back of the CD Changer. No others have the same serial number as yours. You should record the number and other vital information here and retain this book as a permanent record of your purchase to aid identification in case of theft.

Date of Purchase	
Dealer Purchase from	
Dealer Address	
Dealer Phone No.	
Model No.	
Serial No.	

OPERATING CONTROLS AND FUNCTIONS

—FRONT VIEW—

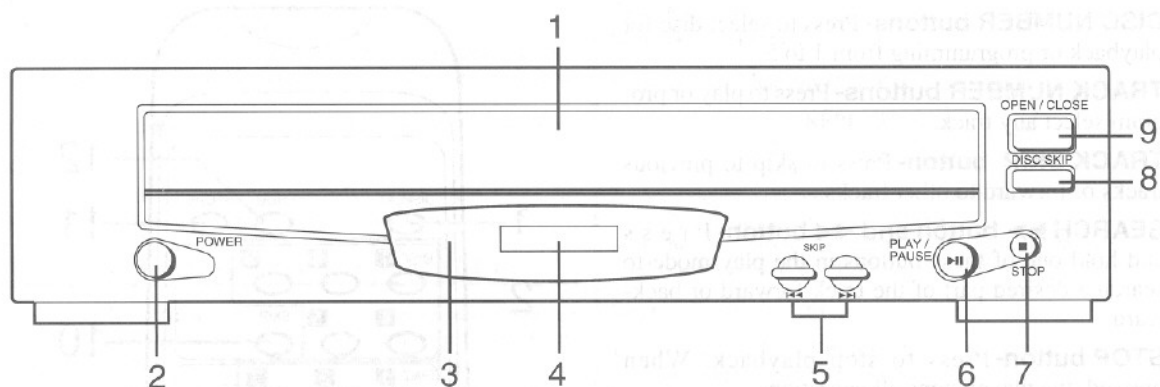

[FIG.1]

—REAR VIEW—

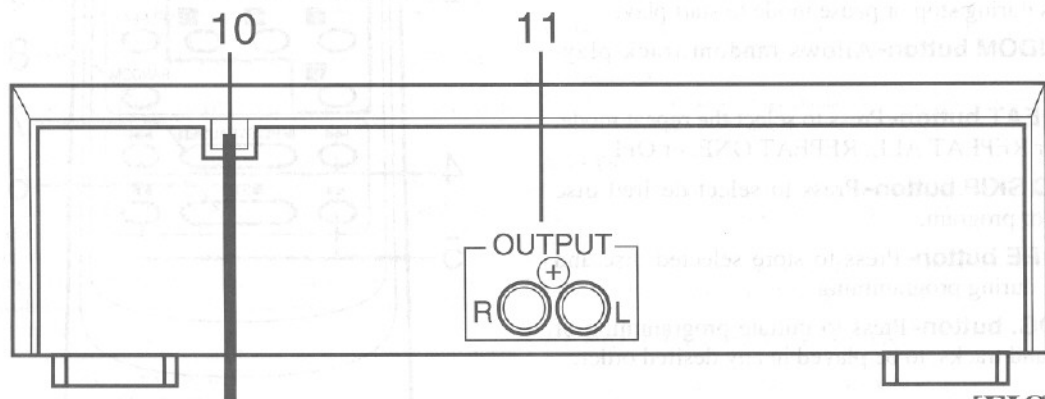

[FIG.2]

- 1. Rotary Disc Tray**
- 2. POWER button-** To turn power on and off.
- 3. REMOTE SENSOR window-** Receives infrared signals from the remote control unit.
- 4. Display**
- 5. TRACK SKIP ◀◀ button and ▶▶ button-** Press one of these buttons in the stop or play mode to select a desired track number on the disc. Each time the buttons are pressed, the track moves forward or backward one track.
- 6. PLAY/PAUSE ▶ / || button-** Press during the playback mode to suspend play. Press during stop or pause mode to start play.
- 7. STOP ■ button-** Press to stop playback. When pressed, the player stops all operations.
- 8. DISC SKIP button-** Press to select disc for playback or programming from 1 to 5.
- 9. OPEN/CLOSE button-** Press to open the disc tray. Press again to close the tray.
- 10. AC Power Cord-** Connect to a 120V AC/ 60 Hz power source.
- 11. OUTPUT jacks-** Connect the stereo audio cable to the CD or AUX input jacks of your receiver or amplifier.

REMOTE CONTROL OPERATION

1. **DISPLAY button**- Press to select the desired display mode: (ELAPSED) TIME or (MUSIC) TRACK NO.
2. **DISC NUMBER buttons**- Press to select disc for playback or programming from 1 to 5.
3. **TRACK NUMBER buttons**- Press to play or program select any track.
4. **TRACK SKIP button**- Press to skip to previous tracks or forward to other tracks.
5. **SEARCH ►► button and ◀◀ button**- Press and hold one of these buttons in the play mode to search a desired part of the track forward or backward.
6. **STOP button**- Press to stop playback. When pressed, the player stops all operations.
7. **PLAY/PAUSE ► / ◻ button**- Press during the playback mode to suspend play. Press during stop or pause mode to start play.
8. **RANDOM button**- Allows random track playback.
9. **REPEAT button**- Press to select the repeat mode, either REPEAT ALL, REPEAT ONE, or OFF.
10. **DISC SKIP button**- Press to select desired disc play or program.
11. **STORE button**- Press to store selected disc and track during programming.
12. **PROG. button**- Press to initiate programming of disc and tracks, to be played in any desired order.

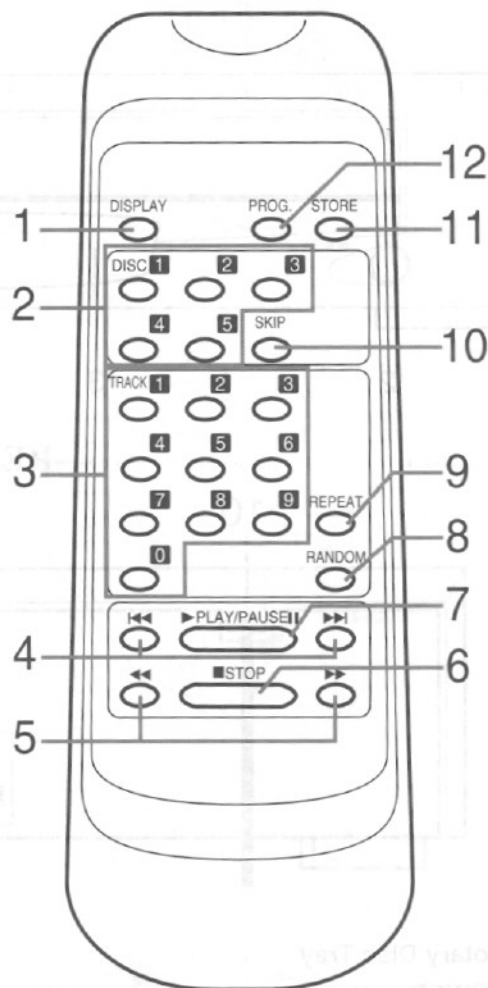

[FIG.3]

1

Turn off the CD player and the amplifier.

2

Connect one end of the supplied audio cable to the CD changer's L (Left) and R (Right) LINE OUT jacks, matching the red plug to the red R jack and the white plug to the white L jack.

3

Connect the other end of the cable to the receiver/amplifier's corresponding left and right CD, AUX, or TAPE input jacks.

4

Plug the CD Changer's power cord into a standard AC outlet.

Notes:

Turn off the power to the components when connecting or disconnecting the audio connection cable.

Do not connect CD Changer to the Phono input jack of the stereo amplifier.

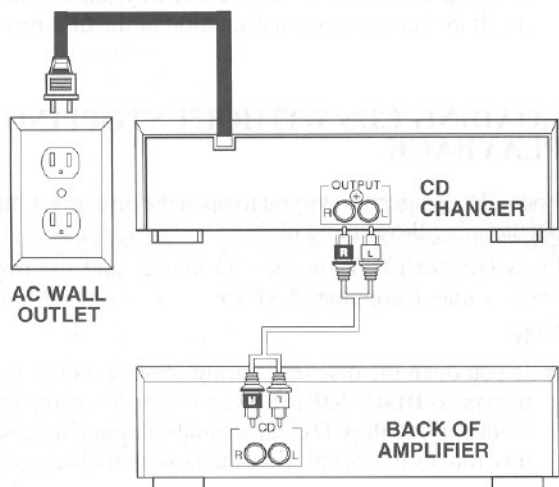

[FIG.4]

INSTALLING THE BATTERIES

Your CD changer's remote control requires two AA batteries for power.

1

Open the battery compartment cover by pressing the cover on the remote unit in the direction of the arrow.

2

Insert 2 "AA" penlight batteries into the battery compartment in the direction indicated by the polarity (+/-) markings.

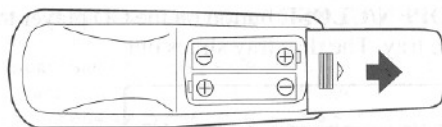

3

Replace the cover.

Cautions:

- Use only batteries of the recommended size and type. Other batteries might damage the remote control.

Never leave dead or weak batteries in the remote control. They can leak chemicals and corrode the control.

OPERATION

LOADING DISC

You may load up to 5 compact discs into Your CD changer.

1.

Press the **POWER** button on the CD player.

NOTE:

If the rotary tray No. 1 is not located in the first position, another number (2 – 5) will be displayed.

2.

Press **OPEN/CLOSE** button on the CD player to open the disc tray. The disc tray slides out.

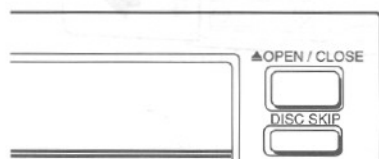

3.

Place disc with the label facing upward, in the tray.

NOTE:

Both 3" (8cm) and 5" (12cm) compact discs can be played. Place only one disc at a time in each disc tray.

4.

To load another disc, press **DISC SKIP** button to turn each rotary tray clockwise in order. You can place up to 5 discs on the tray.

5.

To close the disc tray, press **OPEN/CLOSE** button again.

6.

To check the total time of each disc, press the **DIS-PLAY** button on the remote control to time mode and then **DISC SKIP** button for each disc after all the discs are loaded.

NOTES:

- Do not touch the playing surface of discs (the blank sides) with your hands or fingers.
- Circles around the disc number indicate the trays where discs are loaded. No circle indicates no disc in that compartment.
- You can open and close the disc tray while playing back.

In this case, You can put or replace the discs which are accessible.

You can start playing back by pressing the **PLAY/PAUSE** button even though the disc tray opens.

After that, you can close the disc tray by pressing the **OPEN/CLOSE** button.

CAUTIONS:

- Do not place any foreign objects in the disc tray. It may result in malfunction.
- If your finger or any object should get caught in the disc tray, press **OPEN/CLOSE** button to open the disc tray.
- Do not force the disc tray open or closed by hand.
- To prevent the entry of dust and dirt, keep the disc tray closed when unit is not in use.
- Do not press down hard on the disc tray, since it may result in damage to or malfunction of the disc tray.

LOADING CDS WITHOUT STOPPING PLAYBACK

Your CD changer allows you to open the disc tray without stopping the playing disc.

Press **OPEN/CLOSE** on the CD player, and the tray opens without stopping playback.

Note:

- If you open the disc tray during playing a disc, but then press **DISC SKIP** to move to other disc compartment in front, the CD changer stops play and the disc tray rotates to start playing the next available disc.

NORMAL PLAYBACK

1.

Turn on the amplifier and select input source to which this unit is connected.

2.

Follow the steps in "LOADING DISC".

3.

Select the disc No. 1 with **DISC SKIP** button.

4.

Press **PLAY/PAUSE** button.

The Play \triangleright indicator lights, and playback will start with the first track on the selected disc number 1. All the discs until disc No. 5 are played in sequence.

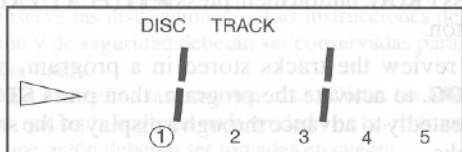

5.

The display shows the disc and track numbers that are playing.

To change the display to show the elapsed time from the beginning of the current track, press **DISPLAY** button on the remote. Press it again to return to the normal track display.

6.

To stop play, press **STOP** button.

To pause during playback to temporarily stop disc, press **PLAY/PAUSE** button.

To start play from the pause or stop mode, press **PLAY/PAUSE** button.

NOTES:

- If you press the **DISC SKIP** button while a disc is playing, the disc tray moves ahead automatically to the next available disc, and play.
- To select a disc directly, press the **DISC NUMBER** buttons on the remote control. The disc begins to play automatically.
- When the first disc ends, the player automatically loads and plays the second disc.
- When the last disc 5 (or the last available disc if there is no disc in compartment 5) ends, the player automatically enters stop mode.

CHOOSING A SPECIFIC TRACK

1.

During playback or stop mode, select your desired disc number with the **DISC SELECT** buttons on the remote control. Playback automatically starts with the first track on the selected disc.

2.

Select a track number with the \lll or \ggg button or by using the **TRACK NUMBER** buttons on the remote control.

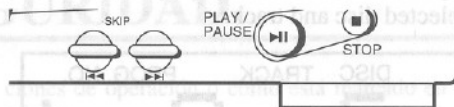

MANUAL SEARCH

During play, this function allows you to quickly advance or reverse through the disc to find the desired part of the track.

1.

Press and hold the \ggg button on the remote control during playback to quickly advance through the disc.

NOTE:

The player will enter the stop mode when the end of the last disc is reached.

2.

Press and hold the \lll button during playback to quickly return through the disc being played.

3.

Release the \ggg or \lll button to resume normal playback.

NOTE:

High frequency information can damage speakers. To avoid this, reduce the volume when using the search mode.

PROGRAMMING PLAY

By selecting disc numbers from 1 to 5, and track numbers, you can choose up to 32 selections for playback in the order you like.

1.

Press **STOP** ■ button to cancel any active functions.

2.

Press **PROG.** button on the remote control to enter the program mode. The display shows "PROG." and the program step number as "1". The display also shows the currently selected disc and track.



3.

Press **DISC SKIP** button or use **DISK NUMBER** buttons on the remote control unit to select your desired disc number.

The display shows the selected disc number.

4.

Press the **◀◀** or **▶▶** button to select a track number. You can also select the track by using **TRACK NUMBER** buttons on the remote control unit. The display shows the selected track number.

5.

Press **STORE** button. The first selection is now programmed in memory and second selection is ready to be programmed.

6.

Repeat steps 3, 4 and 5 for all the selections you want to program, up to the maximum of 32.

7.

Press **PLAY/PAUSE** ▶ / || button. The selections programmed will play in the order you entered them.

NOTES:

- Press **◀◀** or **▶▶** to move backward or forward through the programmed sequence while the sequence plays.
- When you want to program an entire disc as a selection, you must repeat Steps 4-5 for each track.
- You can use audible search while a programmed sequence plays.
- You cannot use **DISC SKIP**, the **DISC NUMBER** buttons, or the **TRACK NUMBER** buttons during programmed play.
- To finish the Program mode, press **■** (**STOP**) then press **PROG.** button. The program is deactivated but remains stored until you turn off the CD player, or open the disc tray.
- To play a stored program again, press **■** (**STOP**) and press **PROG.** button then, press **▶||** (**PLAY/PAUSE**) button.
- To review the tracks stored in a program, press **PROG.** to activate the program, then press **STORE** repeatedly to advance through a display of the stored tracks.
- To clear the programmed sequence from memory, press **POWER** to turn off the CD changer or press **OPEN/CLOSE** to open and close the disc tray.

REPEAT PLAY

You can set this player to repeat:

A desired track

All the discs

Programmed tracks

Repeat a Desired Track

1.

Press **REPEAT** button on the remote control to show "REP. ONE" on the display. One track on a selected Disk will be repeated.

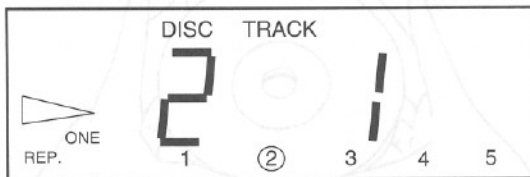

2.

Select the desired Disk number and track number to be repeated with your remote control.

3.

A desired track will be played repeatedly until the **REPEAT** button on your remote control is pressed twice.

REPEAT ALL THE DISCS

1.

Press **REPEAT** button on the remote control until the display shows "REP. ALL".

2.

All the discs in the tray will be played repeatedly until **REPEAT** button is pressed.

REPEAT PROGRAMMED TRACKS

1.

After storing selected tracks in memory, press **REPEAT** button until the display shows "REP. ALL".

2.

All programmed tracks on the discs will be played repeatedly until **REPEAT** button is pressed.

NOTES:

To cancel the repeat mode, press **REPEAT** button until "REP. ONE" or "REP. ALL" goes off on the display.

You can select the repeat mode before beginning play, or any time during play.

RANDOM PLAY

All tracks on all the discs in the tray are played in random order.

1.

Press **RANDOM** button on the remote control to start random play. The display shows "RAND."

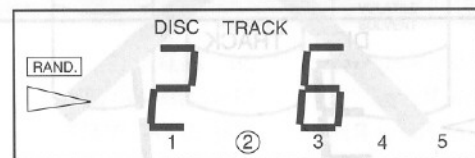

2.

The CD changer continues to randomly select and play tracks until you press **STOP**. (RAND. disappears from the display.)

NOTE:

The CD changer does not successively select the same track, but might select the same track during the course of random play.

3.

To stop the random playback, press **STOP** button.

NOTE:

Random playback is not possible in the programming mode.

DISPLAY

When you turn on the CD changer, select a disc with the **DISC SKIP** button, or you press **■ (STOP)** button to stop play, the number of the disc you selected and its total number of tracks appears on the display.



- 1 When you press **DISPLAY** button on the remote control, the total playing time of the disc appears on the display.



- 2 When you press **DISPLAY** button again, the display returns to total number of tracks.

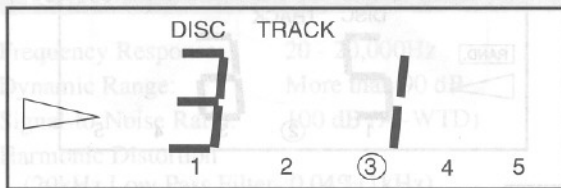

While you are playing a disc, the display shows the number of disc you selected and the track playing.

1. When you press **DISPLAY** button, the elapsed time since the start of the current track appears on the display.



2. When you press **DISPLAY** button again, the display returns to current disc and track number.



NOTE:

A number that does not have a circle around it indicates that there is not a Disk in that position. A circle indicates that there is a Disk in that position. A flashing circle around a number indicates that while in the play mode the **OPEN/CLOSE** button was pushed to change or remove a disk.



Select the desired Disk number and track number to be repeated with your remote control.

A desired track will be played repeatedly until the **REPEAT** button on the remote control is pressed twice.

REPEAT ALL THE DISCS

Press **REPEAT** button on the remote control until the display shows **REP. ALL**.

GENERAL

All the discs in the tray will be played repeatedly until the **REPEAT** button is pressed.
Dimensions:
H: 4-1/16" (101.6mm)
W: 16-15/16" (430mm)
D: 14-1/16" (360mm)
Weight: 8.44lb (3.8kg)

ACCESSORIES

Remote Control unit with 2 "AA" batteries
Audio Cable

* Specifications and design subject to change without notice and without our legal obligation.

CARE AND MAINTENANCE

DISC HANDLING

- Use discs which have mark on them as shown. (Optical audio digital discs.)

COMPACT
disc
DIGITAL AUDIO

- Handle the discs so that fingerprints and dust do not adhere to the surfaces of the discs.

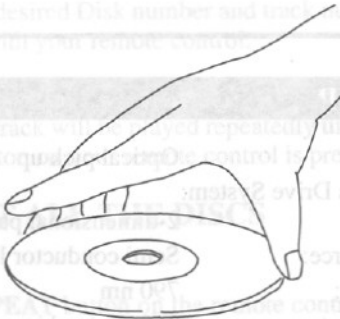
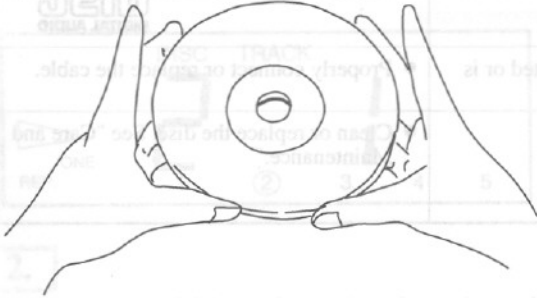

- Always store the disc in its protective case when it is not used.

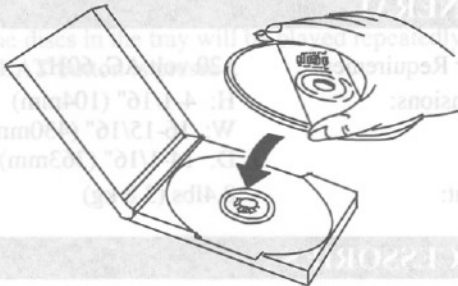

- To clean-off, use a soft cloth.
- Do not use a hard cloth since this will mar the disc.
- Wipe the disc in a straight line from center to edge.
- Never wipe with a circular motion.

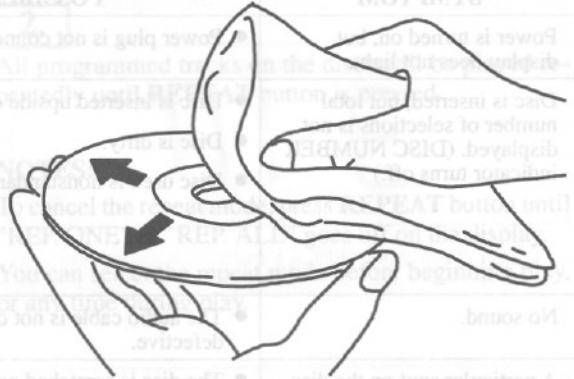

- Do not use detergent or abrasive cleaning agents.

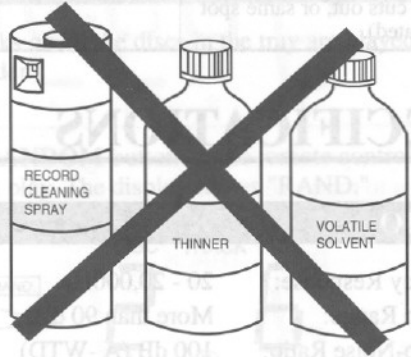

CLEAN CABINET AND PANELS WHEN DIRTY

- Clean off dirt on the surfaces with a dry cloth.
- Never use thinner, benzene or alcohol since these will damage the surface finish.

TROUBLESHOOTING GUIDE

If you have followed the instructions contained in this manual and have difficulty in operating your CD changer, locate the SYMPTOM in the left column below. Check the corresponding POSSIBLE CAUSE and CORRECTIVE ACTION columns to remedy the problem.

SYMPTOM	POSSIBLE	CORRECTIVE ACTION
Power is turned on, but display does not light.	<ul style="list-style-type: none"> Power plug is not connected securely. 	<ul style="list-style-type: none"> Plug AC cord into a standard AC outlet.
Disc is inserted, but total number of selections is not displayed. (DISC NUMBER indicator turns off.)	<ul style="list-style-type: none"> Disc is inserted upside down. Disc is dirty. Disc used is nonstandard. 	<ul style="list-style-type: none"> Reload the disc with its label side up. Clean the disc or try a different disc. Load a disc that has the standard compact disc logo. 
No sound.	<ul style="list-style-type: none"> The audio cable is not connected or is defective. 	<ul style="list-style-type: none"> Properly connect or replace the cable.
A particular spot on the disc does not play correctly (sound cuts out, or same spot is repeated).	<ul style="list-style-type: none"> The disc is scratched or dirty. 	<ul style="list-style-type: none"> Clean or replace the disc. See "Care and Maintenance."

SPECIFICATIONS

AUDIO

Frequency Response:	20 - 20,000Hz
Dynamic Range:	More than 90 dB
Signal-to-Noise Ratio:	100 dB (A -WTD)
Harmonic Distortion (20kHz Low Pass Filter:-0.04%(1kHz)	
Separation:	85 dB
Wow and Flutter:	Not measurable
Diameter:	4-3/4-inch (120 mm), 3-1/8-inch (80 mm)

SIGNAL FORMAT

Sampling Frequency:	44.1kHz
Oversampling:	8 times
Quantization Number:	16 Bit LINEAR
Transmission Bit Rate:	4.3218 MHz
Signal Processing Rate:	352.8 KHz

- Specifications and design subject to change without notice and without our legal obligation.

PICK-UP

TYPE:	Optical pick up
Object Lens Drive System:	2-dimensional parallel drive
Optical Source:	Semi conductor laser
Wavelength:	790 nm
Tracking System:	360 ms tracking system

GENERAL

Power Requirements:	120 volt AC, 60Hz
Dimensions:	H: 4-1/16" (104mm) W: 16-15/16" (430mm) D: 14-1/16" (363mm)
Weight:	8.4lbs (3.8 kg)

ACCESSORIES

Remote Control unit with 2 "AA" batteries
Audio Cable

FUNAI CORPORATION

LIMITED WARRANTY

FUNAI CORP. will repair this product, free of charge in the USA in the event of defect in materials or workmanship as follows:

DURATION:

PARTS: FUNAI CORP. will provide parts to replace defective parts without charge for one (1) year from the date of original retail purchase. Two (2) years for Picture Tube. Certain parts are excluded from this warranty.

LABOR: FUNAI CORP. will provide the labor without charge for a period of ninety (90) days from the date of original retail purchase.

LIMITS AND EXCLUSIONS:

This warranty is extended only to the original retail purchaser. A purchase receipt or other proof of original retail purchase will be required together with the product to obtain service under this warranty.

This warranty shall not be extended to any other person or transferee.

This warranty is void and of no effect if any serial numbers on the product are altered, replaced, defaced or missing. This FUNAI CORPORATION Limited warranty does not apply to any the product not purchased and used in the United States.

This warranty only covers failures due to defects in material or workmanship which occur during normal use. It does not cover damage which occurs in shipment, or failures which are caused by repairs, alterations or product not supplied by FUNAI CORP., or damage which results from accident, misuse, abuse, mishandling, misapplication, alteration, faulty installation, improper maintenance, commercial use such as hotel, rental or office use of this product or damage which results from fire, flood, lightning or other acts of God.

THIS WARRANTY DOES NOT COVER PACKING MATERIALS, ANY ACCESSORIES (EXCEPT REMOTE CONTROL), ANY COSMETIC PARTS, COMPLETE ASSEMBLY PARTS, DEMO OR FLOOR MODELS.

FUNAI CORP. AND ITS REPRESENTATIVES OR AGENTS SHALL IN NO EVENT BE LIABLE FOR ANY GENERAL, INDIRECT OR CONSEQUENTIAL DAMAGES ARISING OUT OF OR OCCASIONED BY THE USE OF OR THE INABILITY TO USE THIS PRODUCT. THIS WARRANTY IS MADE IN LIEU OF ALL OTHER WARRANTIES, EXPRESS OR IMPLIED, AND OF ALL OTHER LIABILITIES ON THE PART OF FUNAI. ALL OTHER WARRANTIES INCLUDING THE WARRANTY OF MERCHANTABILITY, AND FITNESS FOR A PARTICULAR PURPOSE, ARE HEREBY DISCLAIMED BY FUNAI AND ITS REPRESENTATIVES IN THE UNITED STATES. ALL WARRANTY INSPECTIONS AND REPAIRS MUST BE PERFORMED BY FUNAI AUTHORIZED SERVICE CENTER. THIS WARRANTY IS VALID WHEN THE UNIT IS CARRIED-IN TO FUNAI AUTHORIZED SERVICE FACILITY.

WHEN YOU ARE RETURNING THE PRODUCT FOR SERVICE TO THE FACTORY SERVICE CENTER, PLEASE CONTACT THE FUNAI SERVICE DEPARTMENT TO RECEIVE A R.A. (REPAIR AUTHORIZATION) NUMBER PRIOR TO SHIPPING. ANY POSTAGE, INSURANCE AND SHIPPING COST, INCURRED IN PRESENTING OR SENDING YOUR FUNAI/SYMPHONIC PRODUCT FOR SERVICE ARE SHIPPER'S RESPONSIBILITY.

CAREFULLY PACK WITH PROPER PACKING MATERIALS, PREFERABLY IN THE ORIGINAL CARTON.

ATTACH WRITTEN DOCUMENTATION DETAILING THE COMPLAINT, TO THE OUTSIDE OR INSIDE OF THE CARTON.

THE PRODUCT MUST BE ACCOMPANIED BY A COPY OF THE ORIGINAL RETAIL PURCHASE RECEIPT. IF NO PROOF OF PURCHASE IS ATTACHED, THE WARRANTY WILL NOT BE HONORED AND REPAIRS COSTS WILL BE CHARGED.

IMPORTANT:

THIS LIMITED WARRANTY GIVES YOU SPECIFIC LEGAL RIGHTS. YOU MAY HAVE OTHER RIGHTS THAT VARY FROM STATE TO STATE. IF, AT ANY TIME DURING THE WARRANTY PERIOD, YOU ARE UNABLE TO OBTAIN SATISFACTION WITH THE REPAIR OF THIS PRODUCT, PLEASE CONTACT FUNAI CORP.

ATTENTION:

FUNAI CORP. RESERVES THE RIGHT TO MODIFY ANY DESIGN OF THIS PRODUCT WITHOUT PRIOR NOTICE.

For information of your nearest FUNAI Authorized Service Center or general service procedure, please call or write to the following:

FUNAI CORPORATION
Factory Service Center
100 North Street; Teterboro, NJ 07608
Tel : 1-800-242-7158