

OWNER'S MANUAL

9-INCH COLOR TV/VCP 9 TVCP

Symphonic

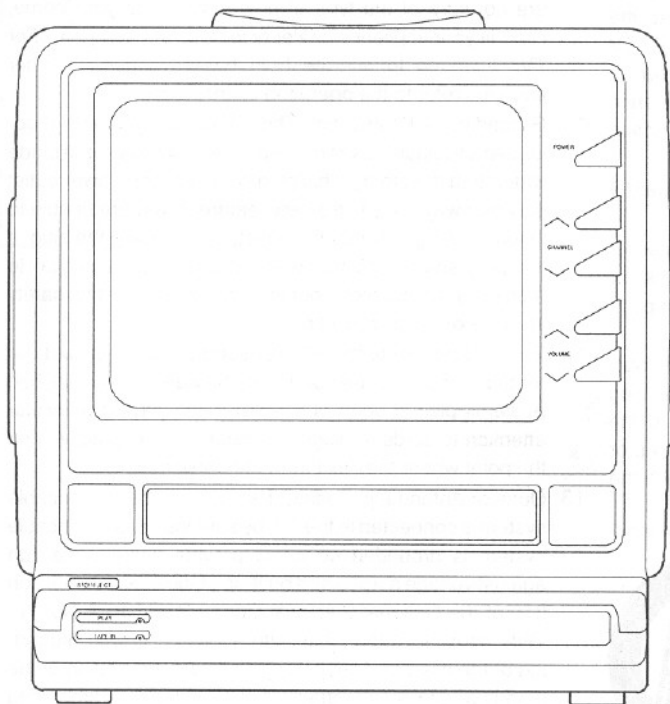

CONTENTS

FEATURES	4
PRECAUTIONS.....	5
SUPPLIED ACCESSORIES	5
LOCATION.....	5
AVOID THE HAZARDS OF ELECTRICAL SHOCK AND FIRE	5
DEW WARNING/INDICATOR.....	5
OPERATING CONTROLS AND FUNCTIONS..	6
REMOTE CONTROL OPERATION	8
HOW TO USE REMOTE CONTROL	8
INSTALLING THE BATTERIES	9
ANTENNA CONNECTIONS.....	10
VHF/UHF RECEPTION AREA USING SEPARATE ANTENNAS	10
VHF/UHF COMBINED ANTENNA.....	11
CABLE AND PAY TV.....	11
MOBILE INSTALLATION	12
CONNECTING ANTENNAS	12
CONNECTING THE CAR-BATTERY.....	12
CONNECTING THE AC CORD	12
PREPARATION FOR USE.....	13
CHANNEL MEMORY PROGRAMMING.....	13
VIDEO CASSETTE	15
OPERATION	16
T.V. OPERATION	16
VIEWING AND RECORDING THE SAME PROGRAM.....	16
SETTING THE SLEEP TIMER.....	18
PLAYBACK.....	18
AUTO REWIND-EJECT.....	19
CUE AND REVIEW (VISUAL SEARCH).....	19
2 STEP SEARCH	20
STILL FRAME DURING PLAYBACK.....	20
TRACKING CONTROL KNOB.....	20
TROUBLESHOOTING GUIDE	21
MAINTENANCE	22
SPECIFICATIONS.....	23
GENERAL SPECIFICATIONS	23
ELECTRICAL SPECIFICATIONS.....	23
OTHER SPECIFICATIONS.....	23

VHS

Please read before using this equipment

WARNING:

TO REDUCE THE RISK OF FIRE OR ELECTRIC SHOCK, DO NOT EXPOSE THIS APPLIANCE TO RAIN OR MOISTURE.

**CAUTION**

**RISK OF ELECTRIC SHOCK
DO NOT OPEN**



CAUTION: TO REDUCE THE RISK OF ELECTRIC SHOCK, DO NOT REMOVE COVER (OR BACK) NO USER SERVICEABLE PARTS INSIDE. REFER SERVING TO QUALIFIED SERVICE PERSONNEL.



THIS SYMBOL INDICATES THAT DANGEROUS VOLTAGE CONSTITUTING A RISK OF ELECTRIC SHOCK IS PRESENT WITHIN THIS UNIT.



THIS SYMBOL INDICATES THAT THERE ARE IMPORTANT OPERATING AND MAINTENANCE INSTRUCTIONS IN THE LITERATURE ACCOMPANYING THE APPLIANCE.

"IMPORTANT SAFEGUARDS"

1. Read instructions-All the safety and operating instructions should be read before the appliance is operated.
2. Retain Instructions-The safety and operating instructions should be retained for future reference.
3. Heed Warnings-All warnings on the appliance and in the operating instructions should be adhered to.
4. Follow Instructions-All operating and use instructions should be followed.
5. Cleaning-Unplug TV from the wall outlet before cleaning. Do not use liquid cleaners or aerosol cleaners. Use a damp cloth for cleaning.
EXCEPTION : A product that is meant for uninterrupted service and that for some specific reason, such as the possibility of the loss of an authorization code for a CATV converter, is not intended to be unplugged by the user for cleaning or any other purpose, may exclude the reference to unplugging the appliance in the cleaning description otherwise required in item 5.
6. Attachments-Do not use attachments not recommended by the TV manufacturer as they may cause hazards.
7. Water and Moisture-Do not use this TV near water-for example, near a bath tub, wash bowl, kitchen sink, or laundry tub, in a wet basement, or near a swimming pool, and the like.
8. Accessories-Do not place this TV on an unstable cart, stand, tripod, bracket, or table. The TV may fall, causing serious injury to someone, and serious damage to the appliance. Use only with a cart, stand, tripod, bracket, or table recommended by the manufacturer, or sold with the TV. Any mounting of the appliance should follow the manufacturer's instructions and should use a mounting accessory recommended by the manufacturer. An appliance and cart combination should be moved with care. Quick stops, excessive force, and uneven surfaces may cause the appliance and cart combination to overturn.
PORTABLE CART WARNING

S3126A
9. Ventilation-Slots and openings in the cabinet and the back or bottom are provided for ventilation and to ensure reliable operation of the TV and to protect it from overheating, these openings must not be blocked or covered. The openings should never be blocked by placing the TV on a bed, sofa, rug, or other similar surface. This TV should never be placed near or over a radiator or heat register. This TV should not be placed in a built-in installation such as a bookcase or rack unless proper ventilation is provided or the manufacturer's instructions have been adhered to .
10. Power Sources-This TV should be operated only from the type of power source indicated on the marking label. If you are not sure of the type of power supply to your home, consult your appliance dealer or local power company. For TVs intended to operate from battery power, or other sources, refer to the operating instructions.
11. Grounding or Polarization-This TV is equipped with a polarized alternating-current line plug(a plug having one blade wider than the other). This plug will fit into the power outlet only one way. This is a safety feature. If you are unable to insert the plug fully into the outlet, try reversing the plug. If the plug should still fail to fit, contact you electrician to replace your obsolete outlet. Do not defeat the safety purpose of the polarized plug.
12. Power-Cord Protection-Power-supply cords should be routed so that they are not likely to be walked on or pinched by items placed upon or against them, paying particular attention to cords at plugs, convenience receptacles, and the point where they exit from the appliance.
13. Outdoor Antenna grounding-If an outside antenna or cable system is connected to the TV, be sure the antenna or cable system is grounded so as to provide some protection against voltage surges and built-up static charges. Section 810 of the National Electrical Code, ANSI/NFPA No. 70-1984, provides information with respect to proper grounding of the mast and supporting structure, grounding of the lead-in wire to an antenna discharge unit, size of grounding conductors, location of antenna-discharge unit, connection to grounding electrodes, and requirements for the grounding electrode. (Fig. A)

FIGURE A

EXAMPLE OF ANTENNA GROUNDING AS PER NATIONAL ELECTRICAL CODE

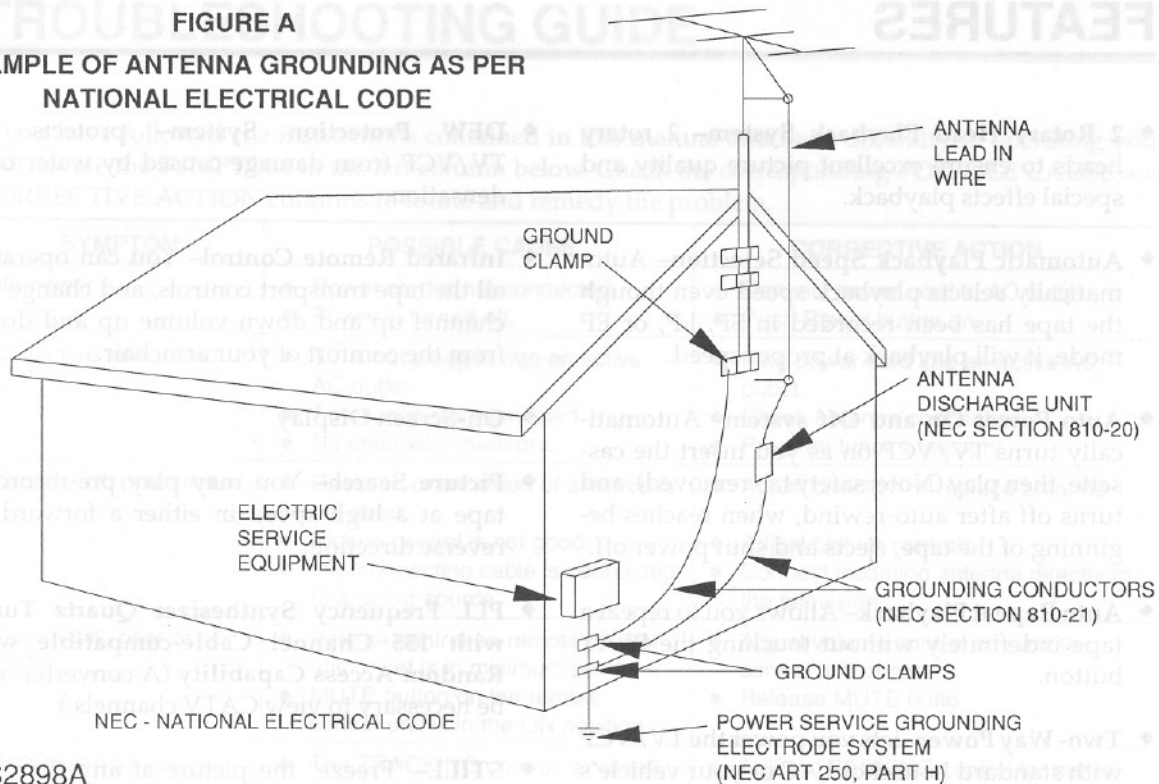

S2898A

14. Lightning-For added protection for this TV receiver during a lightning storm, or when it is left unattended and unused for long periods of time, unplug it from the wall outlet and disconnect the antenna or cable system. This will prevent damage to the TV due to lightning and power-line surges.
15. Power Lines-An outside antenna system should not be located in the vicinity of overhead power lines or other electric light or power circuits, or where it can fall into such power lines or circuits. When installing an outside antenna system, extreme care should be taken to keep from touching such power lines or circuits as contact with them might be fatal.
16. Overloading-Do not overload wall outlets and extension cords as this can result in a risk of fire or electric shock.
17. Object and Liquid Entry-Never push objects of any kind into this TV through opening as they may touch dangerous voltage points or shortout parts that could result in a fire or electric shock. Never spill liquid of any kind on the TV.
18. Servicing-Do not attempt to service this TV yourself as opening or removing covers may expose you to dangerous voltage or other hazards. Refer all servicing to qualified service personnel.
19. Damage Requiring Service-Unplug this TV from the wall outlet and refer servicing to qualified service personnel under the following conditions:
 - a. When the powersupply cord or plug is damaged or trayed.
 - b. If liquid has been spilled, or objects have fallen into the TV.
 - c. If the TV has been exposed to rain or water.
 - d. If the TV does not operate normally by following the operating instructions. Adjust only those controls that are covered by the operating instructions as improper adjustment of other controls may result in damage and will often require extensive work by a qualified technician to restore the TV to its normal operation.
20. Replacement Parts-When replacement parts are required, be sure the service technician had used replacement parts specified by the manufacturer that have the same characteristics as the original part. Unauthorized substitutions may result in fire, electric shock, injury to persons or other hazards.
21. Safety Check-Upon completion of any service or repairs to this TV, ask the service technician to perform routine safety checks to determine that the TV is in proper operating condition.

FEATURES

- ◆ **2 Rotary Head Playback System**– 2 rotary heads to ensure excellent picture quality and special effects playback.
- ◆ **Automatic Playback Speed Selection**– Automatically selects playback speed even though the tape has been recorded in SP, LP, or EP mode, it will playback at proper speed.
- ◆ **Auto Power On and Off system**– Automatically turns TV/VCP on as you insert the cassette, then play (**Note:** safety tab removed), and turns off after auto-rewind, when reaches beginning of the tape, ejects and shut power off.
- ◆ **Auto Repeat Playback**– Allows you to repeat a tape indefinitely without touching the PLAY button.
- ◆ **Two-Way Power**– lets you power the TV/VCP with standard household AC or your vehicle's battery, using the supplied car-battery cord.
- ◆ **Degauss Button**– corrects the picture's color by eliminating magnetism caused by nearby appliances.
- ◆ **DEW Protection System**– protects the TV/VCP from damage caused by water condensation.
- ◆ **Infrared Remote Control**– You can operated all the tape transport controls, and change the channel up and down volume up and down from the comfort of your armchair.
- ◆ **On-Screen Display**
- ◆ **Picture Search**– You may play pre-recorded tape at a high speed in either a forward or reverse direction.
- ◆ **PLL Frequency Synthesizer Quartz Tuner with 155 Channel Cable-compatible with Random Access Capability** (A converter may be necessary to view CATV channels.)
- ◆ **STILL**– "Freeze" the picture at any time, for close viewing of a particular scene. Recorded tape in EP mode shows better clear picture.

The serial number of this product may be found on the back of the unit. No others have the same serial number as yours. You should record the number and other vital information here and retain this book as a permanent record of your purchase to aid identification in case of theft.

Date of Purchase	
Dealer Purchased from	
Dealer Address	
Dealer Phone No.	
Model No.	9 TVCP
Serial No.	

PRECAUTIONS

SUPPLIED ACCESSORIES

Remote Control Unit
With 2 AAA Batteries

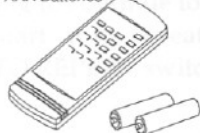

Matching Adapter
(300 ohm - 75 ohm)

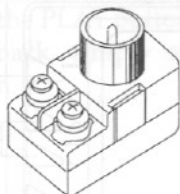

Rod Antenna
(VHF)

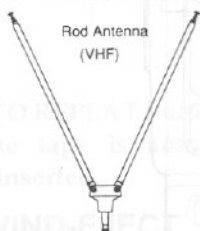

AC Cord

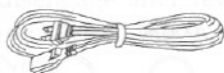

Car Battery Cord

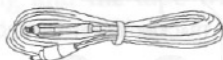

LOCATION

For safe operation and satisfactory performance of your unit, keep the following in mind when selecting a place for its installation:

- ◆ Shield it from direct sunlight and keep it away from sources of intense heat.
- ◆ Avoid dusty or humid places.
- ◆ Avoid places with insufficient ventilation for proper heat dissipation. Do not block the ventilation holes at the top and bottom of the unit. Do not place the unit on a carpet because this will block the ventilation holes.
- ◆ Install unit in a horizontal position.
- ◆ Avoid locations subject to strong vibration.
- ◆ Do not place the unit near strong magnetic fields.
- ◆ Do not move the unit from a cold to a hot place or vice versa.

AVOID THE HAZARDS OF ELECTRICAL SHOCK AND FIRE

- ◆ Do not handle the power cord with wet hands.
- ◆ Do not pull on the power cord when disconnecting it from an AC wall outlet. Grasp it by the plug.
- ◆ If, by accident, water is spilled on your unit, unplug the power cord immediately and take the unit to an authorized video service center for servicing.
- ◆ Do not put your fingers or objects into the VCP cassette holder.
- ◆ Do not place anything directly on top of the unit.

DEW WARNING/INDICATOR

This video cassette player is equipped with a sensor which prevents DEW condensation. If excessive moisture is present inside the unit, the DEW letter on the display. While the indicator appears, safety device prevents the unit from operating until moisture is gone. Moisture condensation may occur inside the unit when it is removed from a cold place to a warm place, or after heating a cold room or under conditions of high humidity.

Therefore when the DEW letter appears, turn the POWER button off and allow at least 2 hours for the unit to dry out.

Note: DEW indicator may not go on for first 15 minutes even if moisture condensation may occur inside the unit when room temperature or humidity changes suddenly. In this case, do not insert the cassette for first 30 minutes.

OPERATING CONTROLS AND FUNCTIONS

— FRONT VIEW —

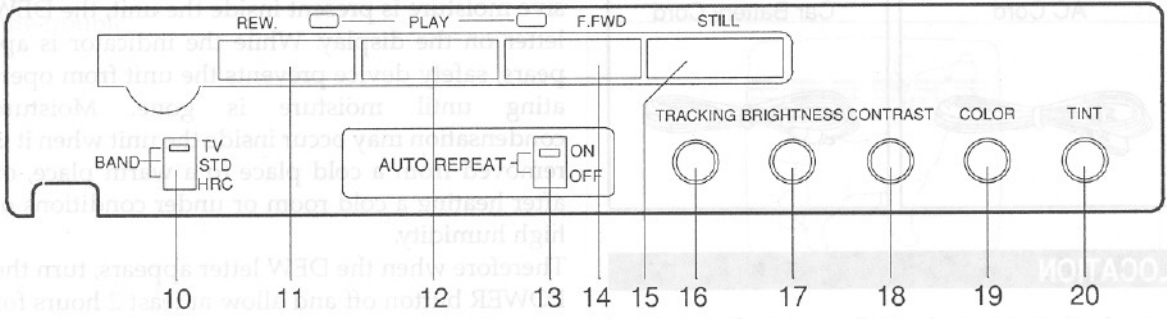
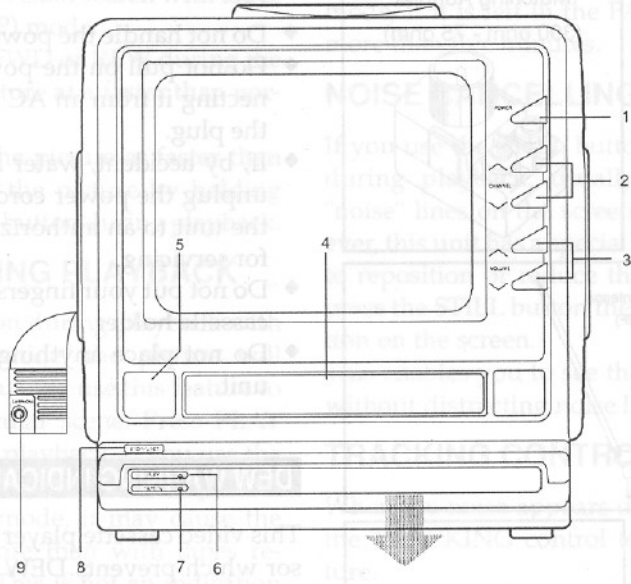

— REAR VIEW —

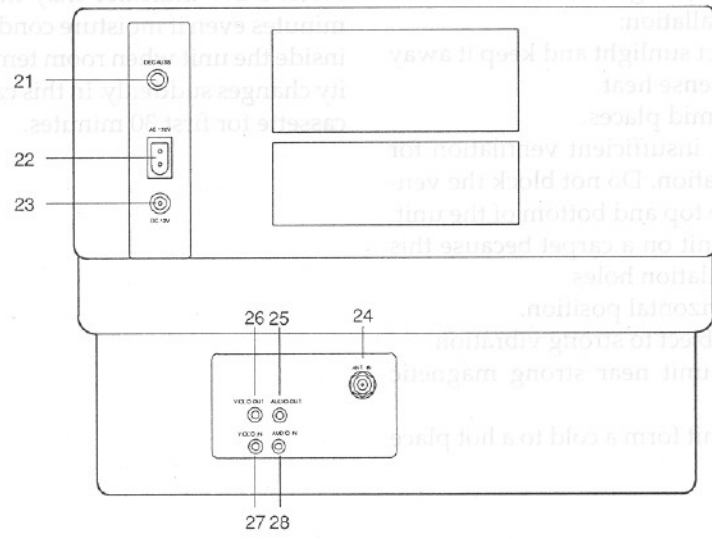

- 1 **POWER button**– To turn the unit on and off.
- 2 **CHANNEL UP/DOWN button**– To select the channel for viewing or recording.
- 3 **VOLUME UP/DOWN button**– To adjust the volume level.
- 4 **CASSETTE COMPARTMENT**
- 5 **REMOTE SENSOR**– Receives the infrared control signals from the handheld remote control unit.
- 6 **PLAY indicator**– lights when in the Play mode.
- 7 **TAPE IN indicator**– lights when the cassette tape is inserted.
- 8 **STOP/EJECT button**– To stop tape motion and remove the tape from VCR.
- 9 **EARPHONE jack**– To connect earphones (not supplied) for personal listening.
- 10 **BAND selector switch** – To select TV or CATV(STD/HRC) mode.
- 11 **REW. button**– To rewind tape, or to view video, in reverse, during play mode at a faster than normal speed. Press play button to return VCR to normal playback speed.
- 12 **PLAY button**– To begin playback of a tape.
- 13 **AUTO REPEAT switch**– To select auto repeat playback mode.
- 14 **F.FWD button**– To advance tape faster than normal or to view video, in forward direction, during play mode at a faster than normal speed. Press play button to return VCP to normal playback speed.
- 15 **STILL button**– To view a still Picture during playback. To reduce noise bars on still Picture. May require depressing several times.
- 16 **TRACKING control**– Adjust to minimize video "noise" (lines or dots on screen) during playback.
- 17 **BRIGHTNESS control**– See page 16 for detail.
- 18 **CONTRAST control**– See page 16 for detail.
- 19 **COLOR control**– See page 16 for detail.
- 20 **TINT control**– See page 16 for detail.
- 21 **DEGAUSS button**– Push to eliminating magnetism for corrects the picture's color.
- 22 **AC 120V**– Connect the AC cord.
- 23 **DC 12V**– Connect the Car battery cord.
- 24 **ANT. IN jack**– Connect 75-ohm antenna.
- 25 **AUDIO OUTPUT jack**– Connect to the line in jack of your audio equipment or another VCR.
- 26 **VIDEO OUTPUT jack**– Connect to the video in jack of video processor or another VCR.
- 27 **VIDEO INPUT jack**– Connect to video output jack of your video camera or another VCR.
- 28 **AUDIO INPUT jack**– Connect to audio output jack of a video camera or another VCR.

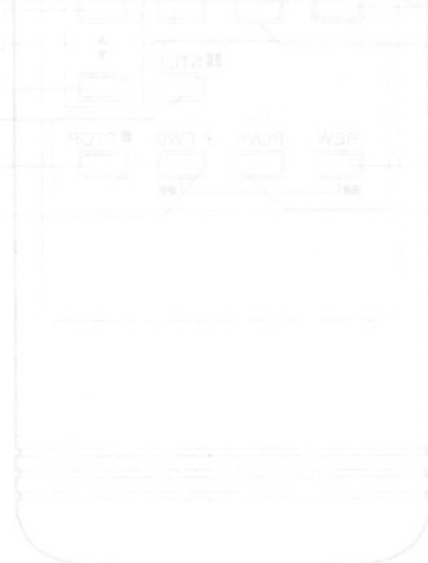

REMOTE CONTROL OPERATION

You can operate all of tape transport functions and TV control functions from the Remote Control (included). The buttons on the Remote Control have the same functions as the corresponding buttons on the unit.

HOW TO USE REMOTE CONTROL

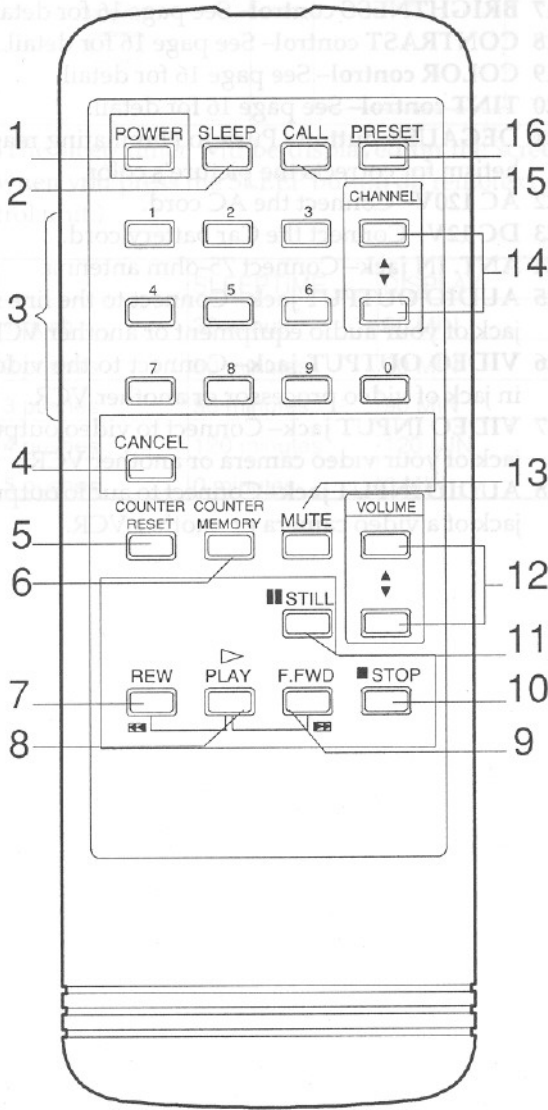

1. **POWER button**— To turn power on and off.
2. **SLEEP button**— To activate the sleep function.
3. **NUMERICAL KEYS**— To select desired channels. They cannot be used to set desired channel during Timer Recording. If you want to select channel among 1 to 9, first 0 Key and then push desired Key among 1 to 9.
4. **CANCEL button**— To cancel memorized Channel Program.
5. **COUNTER RESET button** — To reset counter to 0000.
6. **COUNTER MEMORY button** — To set counter memory-in.
7. **REW button**— To rewind tape, or to view video in reverse during play mode at a faster than normal speed. Press PLAY button to return normal playback speed.
8. **PLAY button**— To playback the tape.
9. **F.FWD button**— To advance tape faster than normal or to view video in forward direction during play mode at a faster than normal speed. Press PLAY button to return normal playback speed.
10. **STOP button**— To stop the tape.
11. **STILL button**- To view a still picture during playback.
12. **VOLUME buttons**—To adjust desired volume level by pressing either "▲" or "▼" button.
13. **MUTE button** — To mute sound. Press again to resume sound.
14. **CHANNEL buttons**— To select desired channel by pressing either "▲" or "▼" button.
15. **CALL button**— To call channel display, counter number, and the current time on the screen.
16. **PRESET button** — To select the channel memory mode.

INSTALLING THE BATTERIES

1
Slide the battery compartment cover on the remote unit in the direction of the arrow.

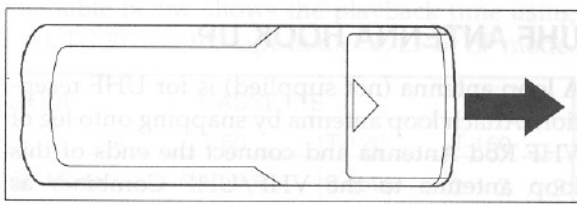

2
Insert 2 "AAA" penlight batteries into the battery compartment in the direction as indicated by the polarity (+/-) markings.

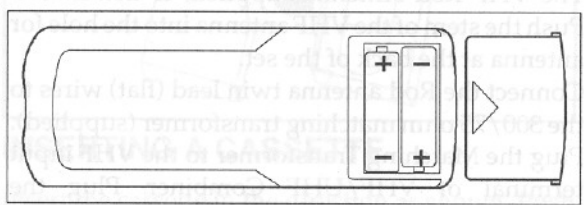

3
Replace the cover

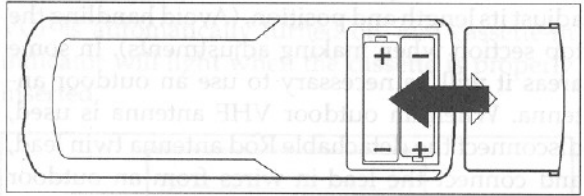

REMOVING CASSETTE

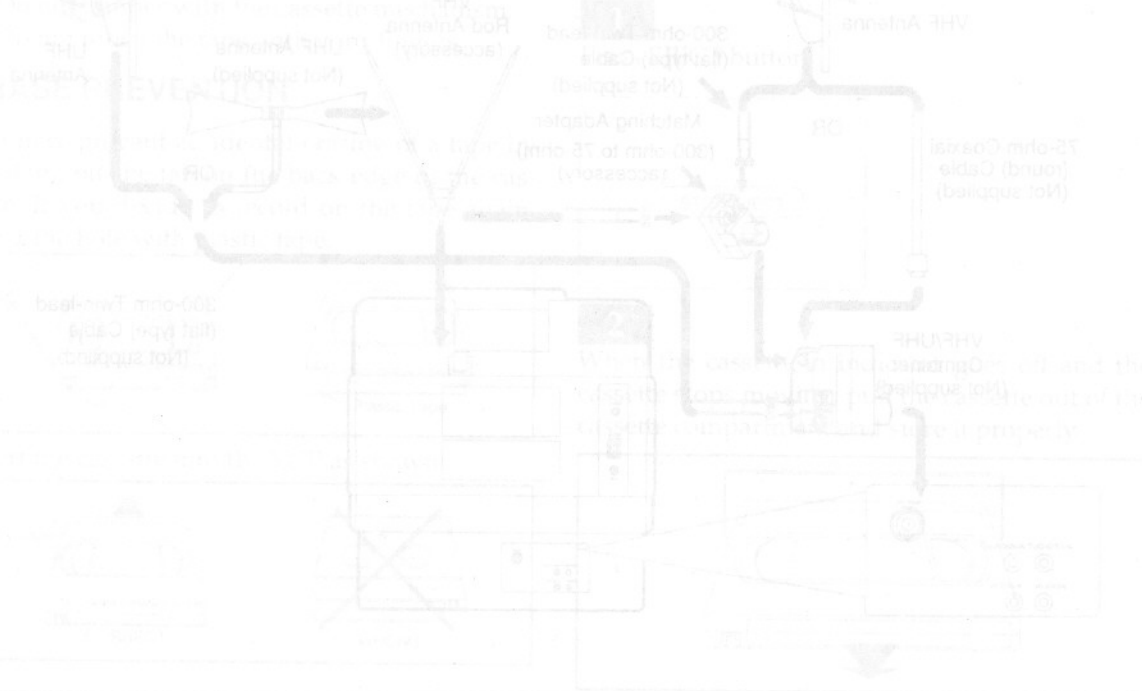

ANTENNA CONNECTIONS

VHF/UHF RECEPTION AREA USING SEPARATE ANTENNAS

VHF ANTENNA HOOK UP

The VHF Rod Antenna (supplied) is detachable. Push the stem of the VHF antenna into the hole for antenna at the back of the set.

Connect the Rod antenna twin lead (flat) wires to the 300/75 ohm matching transformer (supplied). Plug the Matching Transformer to the VHF input terminal of VHF/UHF Combiner. Plug the VHF/UHF combiner (not supplied) to ANT.IN terminal of TV as shown in drawing.

For the best reception, extend the rod antenna and adjust its length and position. (Avoid handling the top section when making adjustments). In some areas it will be necessary to use an outdoor antenna. When an outdoor VHF antenna is used, disconnect the detachable Rod antenna twin lead, and connect the lead-in wires from an outdoor antenna to the terminals of the 300/75 ohm matching transformer as shown in drawing.

If you already have a round type 75 ohm coaxial cable coming from your outdoor antenna, connect to the VHF input terminal of VHF/UHF Combiner then plug the VHF/UHF Combiner to ANT.IN terminal of TV as shown in drawing.

UHF ANTENNA HOOK UP

A loop antenna (not supplied) is for UHF reception. Attach loop antenna by snapping onto leg of VHF Rod Antenna and connect the ends of this loop antenna to the VHF/UHF Combiner as shown in drawing.

Plug the VHF/UHF Combiner to ANT.IN terminal of TV as shown drawing.

The loop antenna can be adjusted in any direction or angle to get the best UHF reception.

NOTE:

If it is difficult to get good reception with the indoor antenna, using an outdoor antenna is recommended. Before an outdoor antenna is connected to the set, the indoor antenna should be disconnected.

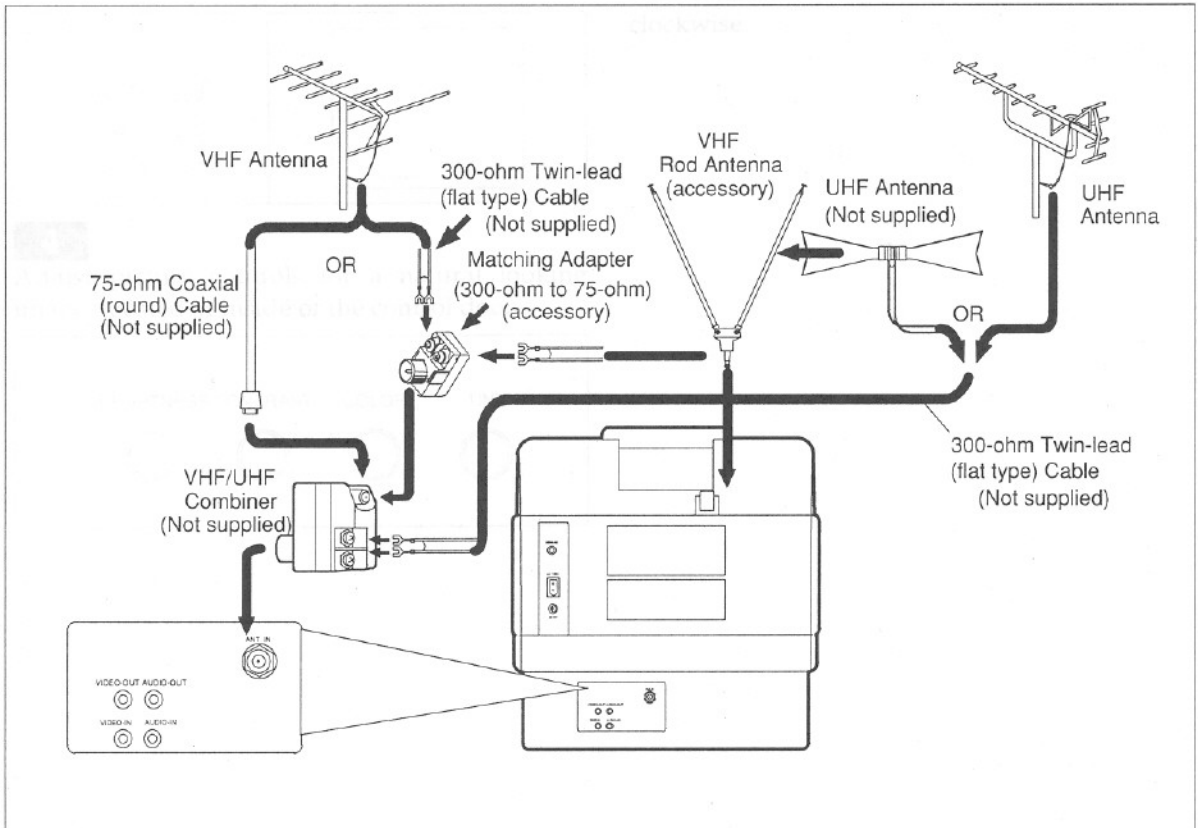

VHF/UHF COMBINED ANTENNA

A VHF UHF 75 ohm combination antenna can be connected to ANT.IN terminal.

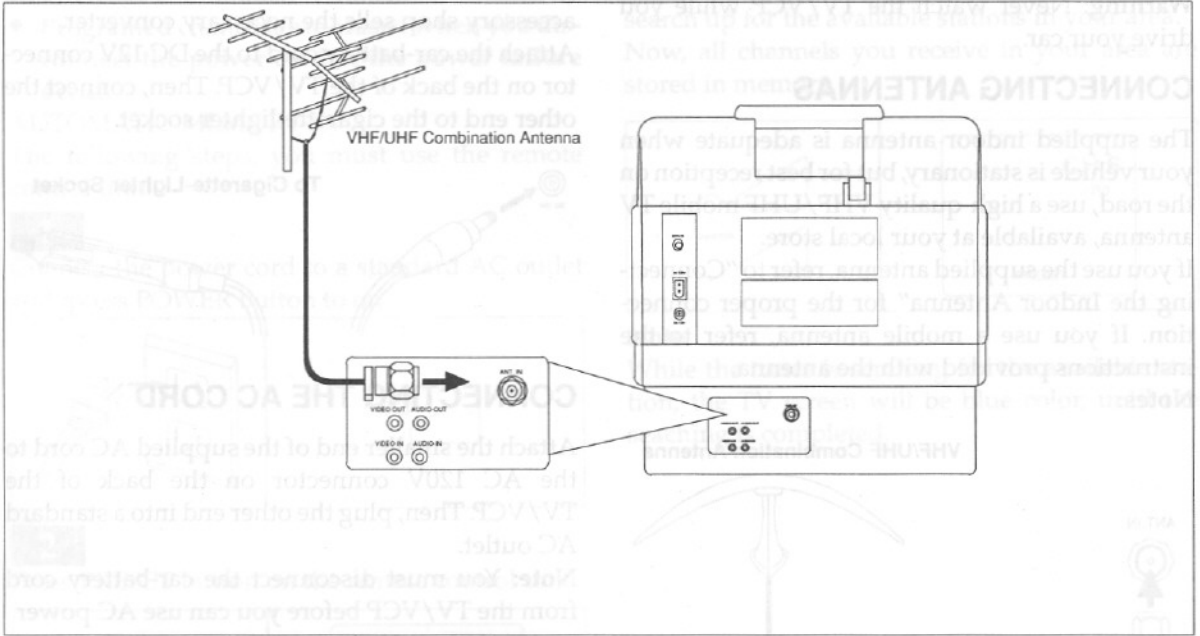

CABLE AND PAY TV

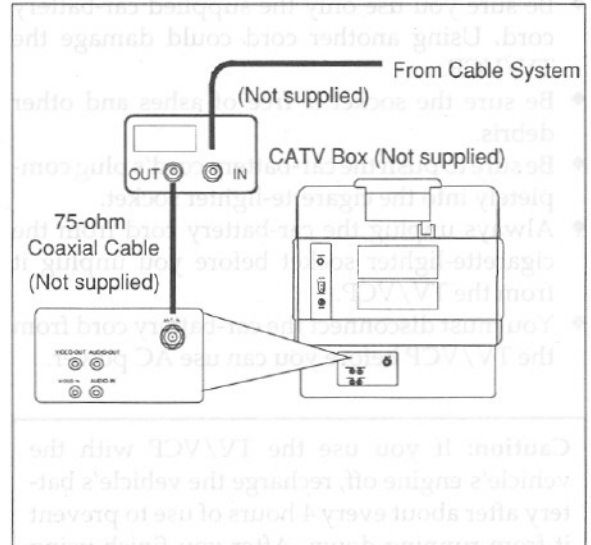
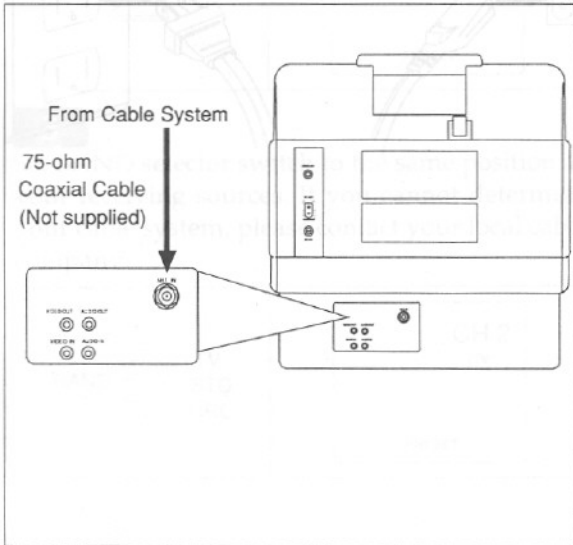

Note to CATV system installer

This reminder is provided to call the CATV system installer's attention to Article 820-40 of the NEC that provides guidelines for proper grounding and, in particular, specifies that the cable ground shall be connected to the grounding system of the building, as close to the point of cable entry as practical.

MOBILE INSTALLATION

You can power the TV/VCP with your vehicle's battery. This lets you and others enjoy the system outdoors and lets your passengers enjoy the system on the road.

Warning: Never watch the TV/VCP while you drive your car.

CONNECTING ANTENNAS

The supplied indoor antenna is adequate when your vehicle is stationary, but for best reception on the road, use a high-quality VHF/UHF mobile TV antenna, available at your local store.

If you use the supplied antenna, refer to "Connecting the Indoor Antenna" for the proper connection. If you use a mobile antenna, refer to the instructions provided with the antenna.

Notes:

VHF/UHF Combination Antenna

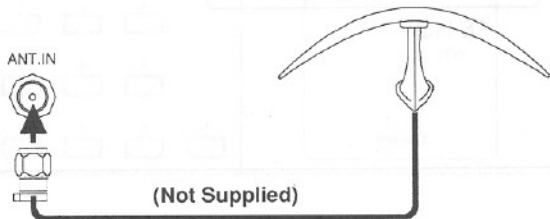

- ◆ Be sure you use only the supplied car-battery cord. Using another cord could damage the TV/VCP.
- ◆ Be sure the socket is free of ashes and other debris.
- ◆ Be sure to push the car-battery cord's plug completely into the cigarette-lighter socket.
- ◆ Always unplug the car-battery cord from the cigarette-lighter socket before you unplug it from the TV/VCP.
- ◆ You must disconnect the car-battery cord from the TV/VCP before you can use AC power.

Caution: If you use the TV/VCP with the vehicle's engine off, recharge the vehicle's battery after about every 4 hours of use to prevent it from running down. After you finish using the TV/VCP, be sure you unplug the car-battery cord from the cigarette-lighter socket.

CONNECTING THE CAR-BATTERY CORD

Be sure your vehicle has a 12-volt, negative-ground electrical system. If it is another type, car accessory shop sells the necessary converter.

Attach the car-battery cord to the DC 12V connector on the back of the TV/VCP. Then, connect the other end to the cigarette-lighter socket.

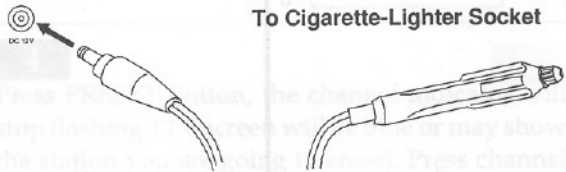

CONNECTING THE AC CORD

Attach the smaller end of the supplied AC cord to the AC 120V connector on the back of the TV/VCP. Then, plug the other end into a standard AC outlet.

Note: You must disconnect the car-battery cord from the TV/VCP before you can use AC power.

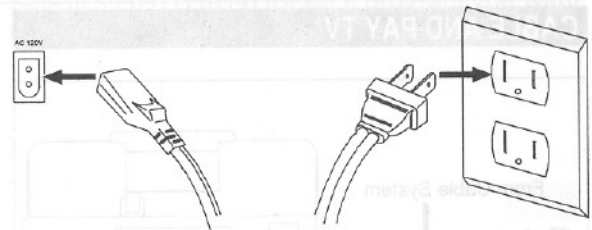

PREPARATION FOR USE

CHANNEL MEMORY PROGRAMMING

You can program the tuner to scan only the channels you receive in your area. (This unit does not receive CATV scrambled channel.)

◆ Programed channels are erased when you disconnect the power cord or the power failure occur.

AUTOMATIC MEMORY-IN

The following steps, you must use the remote control unit.

1

Connect the power cord to a standard AC outlet and press POWER button to on.

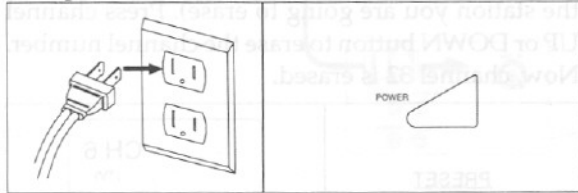

2

Press PRESET button on the remote control unit.

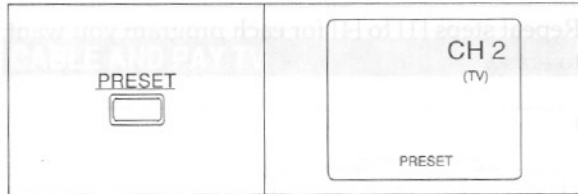

3

Set BAND selector switch to the same position as your receiving sources. If you cannot determine your cable system, please contact your local cable company.



4

Press CHANNEL button.

The channel number indicator will begin to change from 2 and up and the tuner will begin to search up for the available stations in your area. Now, all channels you receive in your area are stored in memory.

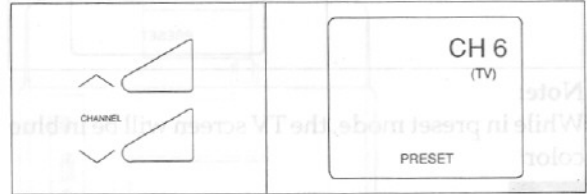

Note:

While the tuner is searching for the available station, the TV screen will be blue color, until the searching is completed.



TO ERASE PRESET CHANNELS

1

Press PRESET button on the remote control unit.

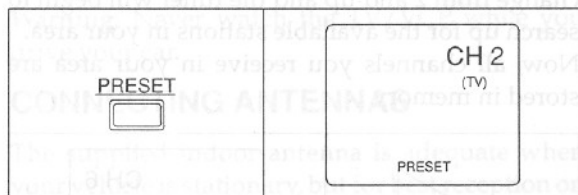

Note:

While in preset mode, the TV screen will be in blue color.

2

Select the channel number you want to erase with 10 keys.

(Example: Channel 32)

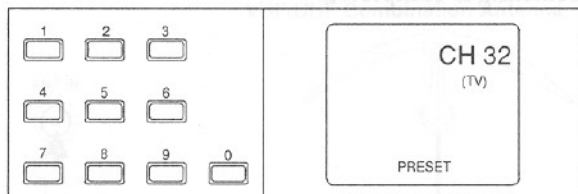

3

Press CANCEL button on the remote control unit. Channel indicator will flash.

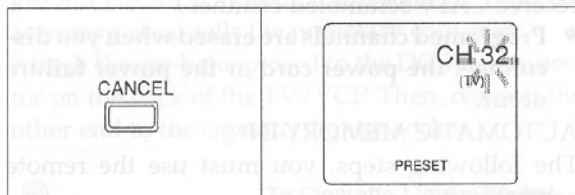

4

Press PRESET button, the channel indicator will stop flashing. (TV screen will be blue or may show the station you are going to erase). Press channel UP or DOWN button to erase the channel number. Now, channel 32 is erased.

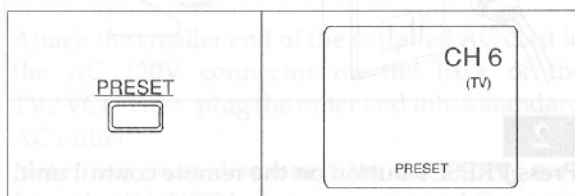

Repeat steps [1] to [4] for each program you want to erase.

VIDEO CASSETTE

This TV/VCP will operate with any cassette that has the VHS mark. For best results we recommend the use of high-quality tape.

The table below shows the playback time using T-60, T-120 or T-160 tape in the SP, LP or EP mode.

MODE	CASSETTE		
	T-60	T-120	T-160
SP Mode	1 hour	2 hours	2 - 2 / 3 hours
LP Mode	2 hours	4 hours	5 - 1 / 3 hours
EP(SLP) Mode	3 hours	6 hours	8 hours

When handling video tapes, take the following precautions

- ◆ Avoid moisture, which can condense on the tape if it is moved from a cold place to a warm one. Playing a tape that has moisture in it will damage the tape and your VCP. Before using a tape with these conditions, wait until the tape has warmed to room temperature and the moisture has evaporated.
- ◆ Avoid extreme heat, high humidity and magnetic fields.
- ◆ Do not tamper with the cassette mechanism.
- ◆ Do not touch the tape with your fingers.

ERASE PREVENTION

You may prevent accidental erasing of a tape by breaking off the tab on the back edge of the cassette. If you decide to record on the tape again, cover the hole with plastic tape.

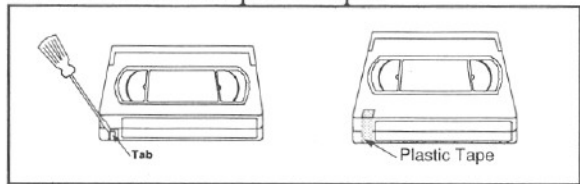

Insert the cassette into the VCP as shown.

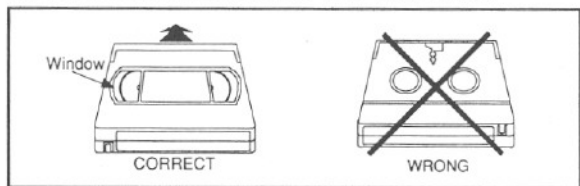

Store the cassette in its case as shown.

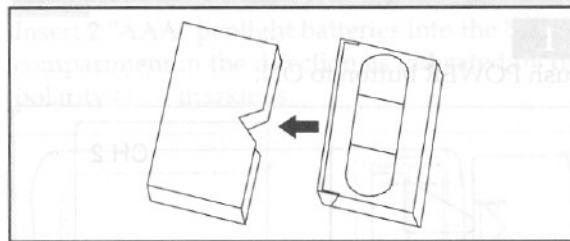

INSERTING A CASSETTE

Insert the cassette in the direction as shown. Push in gently, but continuously, on the center-back of the cassette until it is drawn completely into the VCP.

VCP is automatically turned on, and cassette-in indicator will light when the cassette is properly inserted.

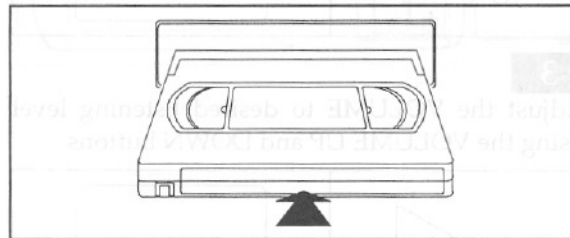

REMOVING A CASSETTE

1

Press EJECT button.



2

When the cassette-in indicator goes off and the cassette stops moving, pull the cassette out of the cassette compartment and store it properly.

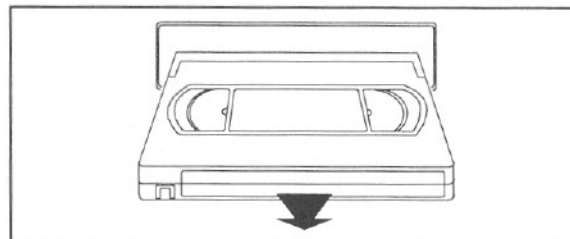

OPERATION CONNECTIONS

T.V. OPERATION

1

Push POWER button to ON.

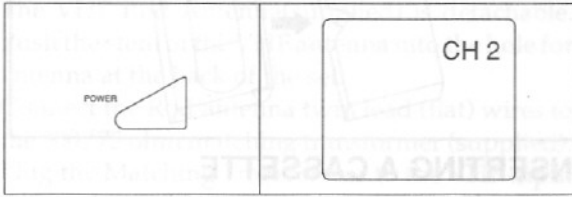

2

Select the desired channel.

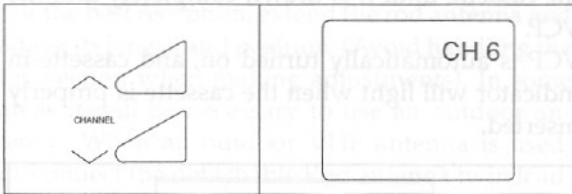

3

Adjust the VOLUME to desired listening level using the VOLUME UP and DOWN buttons

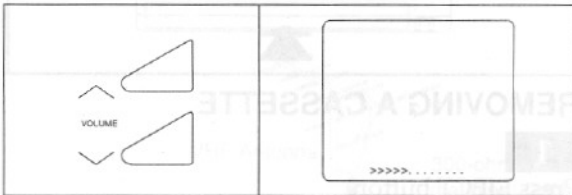

4

Adjust picture controls for a natural looking image (located at inside of the control door).

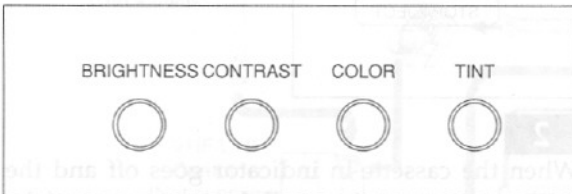

BRIGHTNESS

It controls the brilliance of the picture, to increase brightness, rotate the control clockwise. To decrease brightness, rotate the control counter-clockwise.

CONTRAST

Correct brightness and contrast settings are important to obtain a natural image. To increase the contrast, rotate the control clockwise. To decrease contrast, rotate the control counter-clockwise.

The contrast control will adjust the contrast, brightness and color intensity simultaneously, in proper ratio.

COLOR

Rotate the color control to change the color intensity. If color appears weak and pale, rotate the color control clockwise. If the color appears flushed & brilliant, rotate the control counter-clockwise.

TINT (HUE)

Adjust the tint control as follows: If facial tones are too purple, rotate the tint control counter-clockwise. If facial tones are too green, rotate the control clockwise.

- Avoid extreme heat, high humidity, and magnetic fields.
- Do not tamper with the cassette mechanism.
- Do not touch the tape with your fingers.

ERASE PREVENTION

You may prevent accidental erasing of a tape by breaking off the tab on the back edge of the cassette. If you decide to record on the tape again, cover the hole with plastic tape.



COUNTER MEMORY BUTTON

The MEMORY button can be used during rewind and F.FWD mode to stop tape as tape rewinds to counter display of approx. 0000.

For example, this feature can be used to return the tape to a pre-selected position immediately after recording, or to playback repeatedly a certain portion of a tape.

1

Before playback, press CALL button repeatedly until the counter number is displayed.

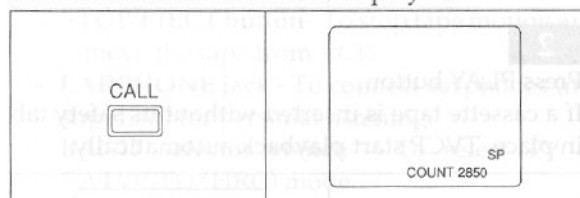

2

Press COUNTER RESET button.

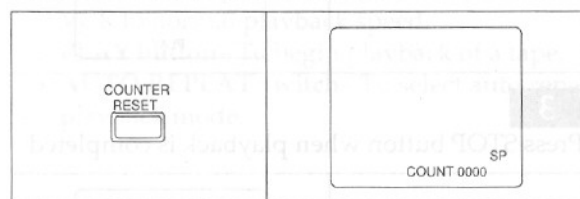

3

Press COUNTER MEMORY button.



4

Press PLAY button.

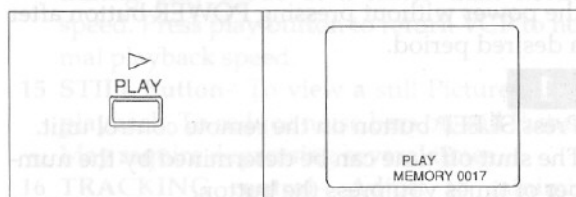

5

Press STOP button when playback is completed.

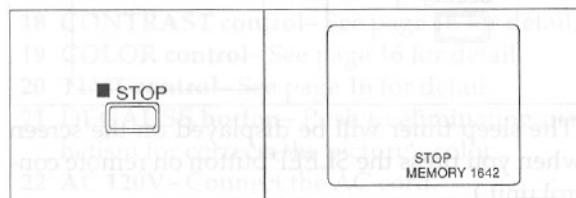

6

Press REW. button.

The tape will stop when the counter reaches to approx. 0000.

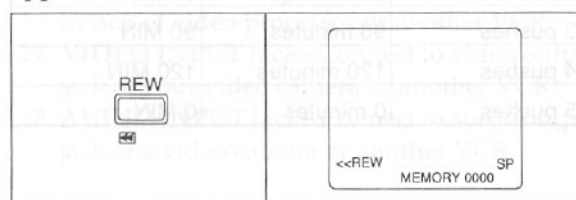

SETTING THE SLEEP TIMER

The sleep timer function enables you to shut off the power without pressing POWER button after a desired period.

1

Press SLEEP button on the remote control unit. The shut off time can be determined by the number of times you press the button.

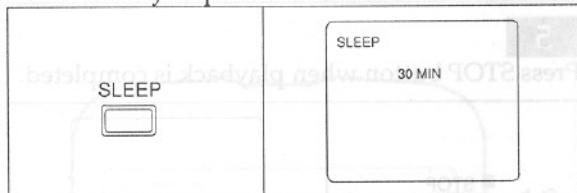

(The sleep timer will be displayed on the screen when you press the SLEEP button on remote control unit.)

	SLEEPTIME	DISPLAY
1 push	30 minutes	30 MIN
2 pushes	60 minutes	60 MIN
3 pushes	90 minutes	90 MIN
4 pushes	120 minutes	120 MIN
5 pushes	0 minutes	0 MIN

PLAYBACK

1

When a pre-recorded tape is inserted, the TVCP will turn on automatically, and TAPE-IN indicator lights.

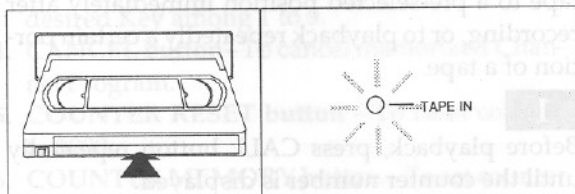

2

Press PLAY button.

If a cassette tape is inserted without its safety tab in place, TVCP start playback automatically.

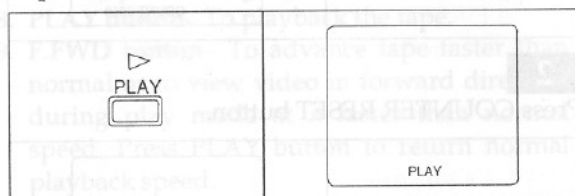

3

Press STOP button when playback is completed.

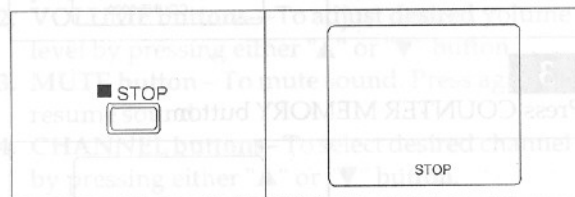

Note: When playback a pre-recorded tape with COPY-GUARD, On-Screen Display may not display normal position or display nothing. This is not an indication of the trouble.

PRECAUTIONS

AUTO REPEAT PLAYBACK

This unit has an auto repeat playback function that allows you to repeat a tape indefinitely without having to continue to push the PLAY button.

To start auto repeat playback, simply set the AUTO REPEAT switch to on.

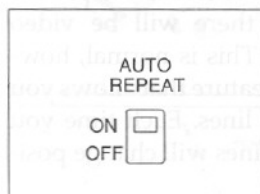

- ◆ When AUTO REPEAT button is ON position, the cassette tape is automatically played whenever inserted.

AUTO REWIND-EJECT

When the end of a tape is reached during playback, or fast-forward, the tape will automatically rewind to the beginning (or to the preset counter memory position). The cassette mechanism will disengage after rewinding and the tape will be ejected and the TVCP will shut itself off.

Note:

- ◆ When tape is rewound to the preset memory position, tape will not be ejected and TVCP will not shut off.

CUE AND REVIEW (VISUAL SEARCH)

You may view the video program at a high speed in either a forward or reverse direction. When in the play mode, press F.FWD button to view the tape at a fast speed in the forward direction. To view the tape at a fast speed in the reverse direction, press REW button. The sound will be muted. This feature is used in finding a particular section of a tape.

Notes:

- ◆ When video searching a pre-recorded tape, it may cause the noise bars (white lines) to move vertically. Also, the picture color fluctuates on and off. This is not an indication of the trouble.
- ◆ You will get best results when playing back tapes that were recorded in the EP mode.
- ◆ To return to normal playback, press PLAY button.
- ◆ The picture will not be as good as normal during CUE and REVIEW.

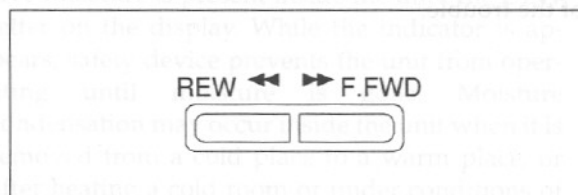

2 STEP SEARCH

This VCP has 2 speeds of visual search with tapes recorded in LP or EP (SLP) mode.

1) Push the button for F.FWD or REW during the playback, to view the picture at a faster than normal speed.

2) If you want to view the picture at faster than above 1), you can view the picture by holding down the F.FWD or REW button during playback.

STILL FRAME DURING PLAYBACK

If you press PAUSE button during playback with tapes recorded in EP mode, the picture will "freeze" on the screen. You may use this feature to study details of a particular scene. Press PLAY button again to continue playback. If you use the PAUSE button during playback with tapes recorded in the SP or LP mode, it may cause the noise bars to appear more than with tapes recorded in the EP mode. This is not an indication of the trouble.

Note:

The TVCP will automatically switch to the Stop mode, if it is left in the PAUSE/STILL mode for more than five minutes.

NOISE CANCELLING

If you use the STILL button to freeze the picture during playback, usually there will be video "noise" lines on the screen. This is normal, however, this unit has a special feature that allows you to reposition or reduce the lines. Each time you press the STILL button the lines will change position on the screen.

This enables you to see the picture in its entirety without distracting noise lines.

TRACKING CONTROL KNOB

When the noise appears during playback, adjust the TRACKING control to achieve the best picture.

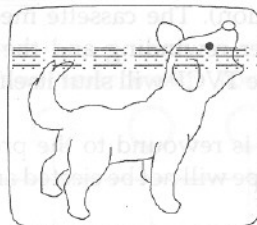

TROUBLESHOOTING GUIDE

If you have followed the instructions contained in this manual and have difficulty in operating your unit, locate the SYMPTOM in the left column below. Check the corresponding POSSIBLE CAUSE and CORRECTIVE ACTION columns to locate and remedy the problem.

SYMPTOM	POSSIBLE CAUSE	CORRECTIVE ACTION
No power.	<ul style="list-style-type: none"> ◆ Power cord is not connected. ◆ Power is turned off. 	<ul style="list-style-type: none"> ◆ Connect power cord to AC outlet. ◆ Push Power button on.
No picture and sound.	<ul style="list-style-type: none"> ◆ TV is not plugged into an active AC outlet. ◆ Antenna is not connected. ◆ No channel in memory. 	<ul style="list-style-type: none"> ◆ Plug power cord into an active AC outlet. ◆ Check antenna connection. ◆ Program tuner's memory
Sound OK; poor picture.	<ul style="list-style-type: none"> ◆ Direction or condition of antenna is not good. ◆ Picture control is not good. ◆ Interconnecting cable is connected to another source. 	<ul style="list-style-type: none"> ◆ Adjust direction or replace antenna. ◆ Adjust picture controls. ◆ Connect incoming antenna directly to the television.
Picture OK; poor or no sound.	<ul style="list-style-type: none"> ◆ Volume control on remote control unit or set is in minimum position. ◆ MUTE button on the remote control unit is in the ON position. 	<ul style="list-style-type: none"> ◆ Adjust volume control on remote control unit or set. ◆ Release MUTE button
Picture is poor on playback.	<ul style="list-style-type: none"> ◆ The TRACKING control is not set to best position. 	<ul style="list-style-type: none"> ◆ Adjust TRACKING control for better picture.
Noise in picture on playback.	<ul style="list-style-type: none"> ◆ Video head is dirty. 	<ul style="list-style-type: none"> ◆ Head cleaning is necessary, consult the nearest dealer.
Operation buttons do not work when power is on and cassette is inserted.	<ul style="list-style-type: none"> ◆ DEW indicator "DEW" is on. 	<ul style="list-style-type: none"> ◆ Wait until indicator goes off, then proceed with operation.
No operation by infrared Remote Control.	<ul style="list-style-type: none"> ◆ No power to TVCP. ◆ Weak battery. 	<ul style="list-style-type: none"> ◆ Make sure the AC cord is connected to an AC outlet. ◆ Check the batteries of infrared Remote Control.

CABINET CLEANING

- ◆ Wipe the front panel and other exterior surfaces of the unit with a soft cloth immersed in lukewarm water and wrung dry.
- ◆ Never use a solvent or alcohol. Do not spray insecticide liquid near the unit. Such chemicals may cause damage and discoloration to the exposed surfaces.

VCP HEAD CLEANING

- ◆ Picture playback may become blurred or interrupted while the TV program received is clear. This does not mean that the recorded program has been erased.

Dirt accumulated on the head after long periods of use causes this problem. Head cleaning requires highly technical skill. Clean heads only when symptom occurs. Bring the unit to your nearest Service Center for a complete cleaning of the heads and cassette compartment.

SERVICING

- ◆ Should your unit become inoperative, do not try to correct the problem by yourself. There are no user-serviceable parts inside. Switch power off, unplug the power cord, and take the unit to your nearest Service Center for servicing.

◆ Check the batteries of infrared Remote Control.	◆ Weak battery.	No operation by infrared Remote Control.
◆ Make sure the AC cord is connected to an AC outlet.	◆ No power to TVCR.	No operation by infrared Remote Control.
◆ Wait until indicator goes off, then proceed with operation.	◆ DEW indicator "DEW" is on.	Operation buttons do not work when power is on and cassette is inserted.
◆ Head cleaning is necessary, consult the nearest dealer.	◆ Videohead is dirty.	Noise in picture or still picture.
◆ Adjust TRACKING control for better picture.	◆ The TRACKING control is not set.	Picture is poor on playback.
◆ Release MUTE button.	◆ MUTE button on the remote control unit is in the ON position.	Picture OK, poor or no sound.
◆ Adjust volume control on remote control unit or set.	◆ Volume control on remote control unit or set is in minimum position.	Picture OK, poor or no sound.
◆ Connect incoming line to the television.	◆ Interconnecting cable is connected to another source.	No picture, no sound.

SPECIFICATIONS

GENERAL SPECIFICATIONS

CRT:	9 inch in-line gun, 90 deflection tube
Television system:	NTSC-M
Playback system:	Rotary two-head helical scan system
Tape width:	1/2 inch
Tuner channel	
TV VHF Low	:#2~#6
TV VHF High	:#7~#13
TV UHF	:#14~#69
CATV	

Terminals:

Antenna input	VHF/UHF 75 ohms unbalanced
Video input	RCA connector
Audio input	RCA connector
Video output	RCA connector
Audio output	RCA connector

ELECTRICAL SPECIFICATIONS

Video input level:	0.5~2.0V _{p-p} , 75Ω
Audio input level:	-10dBs

OTHER SPECIFICATIONS

Power requirement:	AC 120V/60Hz, DC12V
Power consumption:	70W/AC, 50W/DC
Dimensions:	314(W) x 333(D) x 332(H) mm
Weight:	10.6 kg 23.4 lbs

- ◆ Design and specifications are subject to change without notice.

SELECTED CHANNEL INDICATION	CHANNEL BAND DESIGNATIONS	CATV CHANNEL RECEIVED FROM CABLE
2~13	BROADCAST VHF	2~13
14~36	CATV MID/SUPER BANDS	A~W
37~64	CATV HYPER BAND	W+1~W+28
95~99	CATV LOW BAND	A-5~A-1
65~94	ULTRA BAND	W+29~W+58
1	SPECIAL CATV CHANNEL	5A(between 4 and 5)

FUNAI CORPORATION d/b/a SYMPHONIC LIMITED WARRANTY

FUNAI CORP./SYMPHONIC will repair this product, free of charge in the USA in the event of defect in materials or workmanship as follows:

DURATION:

PARTS: FUNAI CORP./SYMPHONIC will provide parts to replace defective parts without charge for one (1) year from the date of original retail purchase. Two (2) years for Picture Tube. Certain parts are excluded from this warranty.

LABOR: FUNAI CORP./SYMPHONIC will provide the labor without charge for a period of ninety (90) days from the date of original retail purchase.

LIMITS AND EXCLUSIONS:

This warranty is extended only to the original retail purchase. A purchase receipt or other proof of original retail purchase will be required together with the product to obtain service under this warranty.

This warranty is void and of no effect if any serial numbers on FUNAI/SYMPHONIC product are altered, replaced, defaced or missing. This FUNAI/SYMPHONIC warranty does not apply to any FUNAI/SYMPHONIC product not purchased and used in the United States.

This warranty only covers failures due to defects in material or workmanship which occurs during normal use. It does not cover damage which occurs in shipment, or failures which are caused by repairs, alterations or product not supplied by FUNAI CORP./SYMPHONIC, or damage which results from accident, misuse, abuse, mishandling, misapplication, alteration, faulty installation, improper maintenance, commercial use such as hotel, rental or office use of this product or damage which results from fire, flood, lightning or other acts of God.

THIS WARRANTY DOES NOT COVER PACKING MATERIALS, ANY ACCESSORIES, ANY COSMETIC PARTS, COMPLETE ASSEMBLY PARTS.

FUNAI CORP./SYMPHONIC AND ITS REPRESENTATIVES OR AGENTS SHALL IN NO EVENT BE LIABLE FOR ANY GENERAL, INDIRECT OR CONSEQUENTIAL DAMAGES ARISING OUT OF OR OCCASIONED BY THE USE OF OR THE INABILITY TO USE THIS PRODUCT. THIS WARRANTY IS MADE IN LIEU OF ALL OTHER WARRANTIES, EXPRESS OR IMPLIED, AND OF ALL OTHER LIABILITIES ON THE PART OF FUNAI/SYMPHONIC, ALL OTHER WARRANTIES INCLUDING THE WARRANTY OF MERCHANTABILITY, AND FITNESS FOR A PARTICULAR PURPOSE, ARE HEREBY DISCLAIMED BY FUNAI/SYMPHONIC AND ITS REPRESENTATIVES IN THE UNITED STATES.

ALL WARRANTY SERVICE MUST BE PERFORMED BY A FUNAI/SYMPHONIC AUTHORIZED SERVICE CENTER. THIS WARRANTY IS VALID WHEN THE UNIT IS CARRIED-IN TO FUNAI/SYMPHONIC AUTHORIZED SERVICE FACILITY.

WHEN YOU ARE RETURNING THE PRODUCT FOR SERVICE TO FACTORY SERVICE CENTER, PLEASE CONTACT THE FUNAI/SYMPHONIC SERVICE DEPARTMENT TO RECEIVE M.R.A. (MERCHANDISE RETURN AUTHORIZATION) NUMBER. ANY POSTAGE, INSURANCE AND SHIPPING COST, INCURRED IN PRESENTING OR SENDING YOUR FUNAI/SYMPHONIC PRODUCT FOR SERVICE ARE SHIPPER'S RESPONSIBILITY.

CAREFULLY PACK WITH PROPER PACKING MATERIALS, PREFERABLY IN THE ORIGINAL CARTON.

ATTACH DETAILING THE COMPLAINT, TO THE OUTSIDE OR INSIDE OF THE CARTON.

THE PRODUCT MUST BE ACCOMPANIED BY A PROOF OF ORIGINAL RETAIL PURCHASE RECEIPT OR A COPY. THERE OF NO PROOF OF PURCHASE IS ATTACHED, THE WARRANTY CANNOT BE HONORED AND REPAIRS COSTS WILL BE CHARGED.

IMPORTANT:

THIS LIMITED WARRANTY GIVES YOU THE LEGAL RIGHTS, AND YOU MAY HAVE OTHER RIGHTS THAT VARY FROM STATE TO STATE, IF, AT ANY TIME DURING THE WARRANTY PERIOD, YOU ARE UNABLE TO OBTAIN SATISFACTION WITH THE REPAIR ON THIS PRODUCT, PLEASE CONTACT FUNAI CORP./SYMPHONIC.

ATTENTION:

FUNAI CORP./SYMPHONIC RESERVES THE RIGHT TO MODIFY ANY DESIGN OF THIS PRODUCT WITHOUT PRIOR NOTICE.

For information of your nearest FUNAI/SYMPHONIC Authorized Service Center or general service procedure, please call or write to the following:

FUNAI CORPORATION DBA SYMPHONIC
Corporate Headquarters & Factory Service Center
Address :100 North Street Teterboro, NJ 07608
Tel :201-288-2666
(Eastern Time 9:00 AM - 4:30 PM)

IMPORTANT: When you return for service to Factory Service Center, please call for Repair Return Authorization prior to shipping.